

# UTS

# UTS

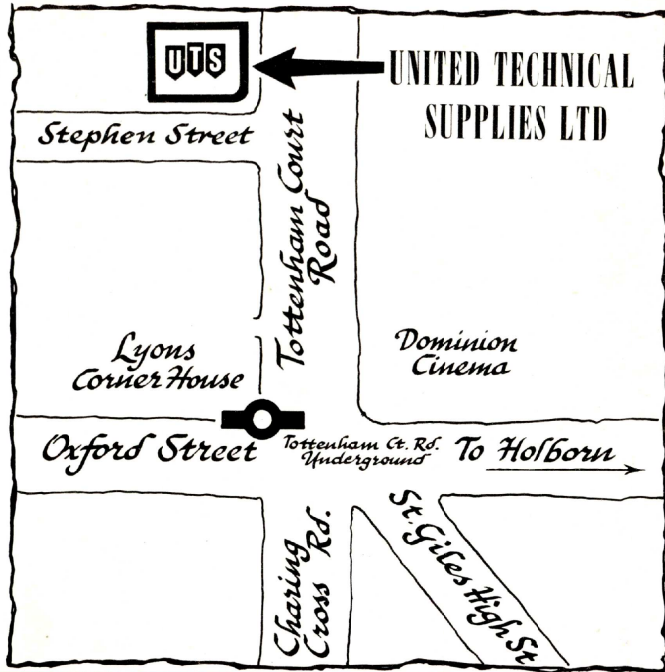

**BINOCULARS  
TELESCOPES  
MONOCULARS  
ASTRONOMICAL  
TELESCOPES  
KITS &  
ACCESSORIES**

## **BRITAIN'S GREATEST OPTICAL & SCIENTIFIC STORE**

WHEN IN LONDON, BE SURE TO VISIT OUR MAIN BRANCH AT 29 TOTTENHAM COURT ROAD, W.1. Only a minute from Tottenham Court Road Underground Station on the Central and Northern Lines.

Buses :

1, 7, 8, 14, 23, 24, 25, 29, 32, 39, 73, 134, 176.

**UNITED TECHNICAL SUPPLIES LTD.**

**29 TOTTENHAM COURT ROAD,  
LONDON, W.1**

LANgham 1116, 1117, 5015.

## **CATALOGUE**

**UNITED TECHNICAL  
SUPPLIES LTD**

29 TOTTENHAM COURT ROAD, LONDON, W.1.

LANgham 1116, 5015, 1117



ABOUT

# BINOCULARS

AND

## HOW TO CHOOSE THEM

The most important factor to consider when choosing your binoculars is the purpose for which you intend using them. Different powers and sizes suit different activities. The Yachtsman, for instance, finds the 7 x 50 more suitable as due to its excellent light gathering ability, it is better for use in failing light than a more powerful glass would probably be. The 6 x 30 is often recommended as a spectator sporting glass because of its lightness and compactness. Unfortunately it is impossible to combine highest magnification, largest field of view and minimum weight and size in any one binocular so therefore one should either choose a good general purpose glass or one that is designed for a specific purpose.

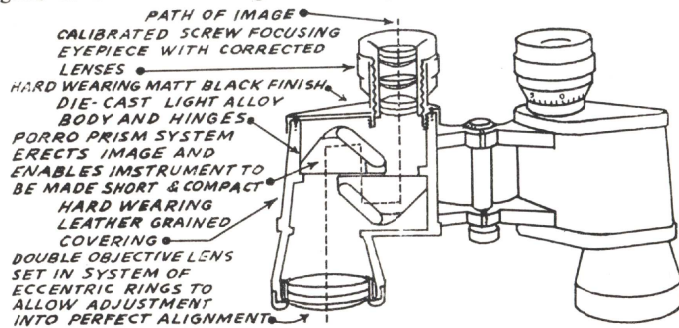

### Four Points to Remember

1. Be sure the binoculars are comfortable to hold. Long periods of holding uncomfortable binoculars can cause much discomfort and particularly unsteadiness.
2. Good binoculars do not strain the eyes, so make sure they are correctly aligned. If after half an hour or so your eyes begin to ache, then the binoculars are out of alignment and need accurate optical adjustment as your eyes are having to strain themselves into position.
3. Be sure to know the meaning of the binocular sizes, i.e. 6 x 30 or 7 x 50. The first figure denotes the power, 6x means 6 power or that the object in view appears to be six times the size as seen with the naked eye. The second figure is the diameter of the objective lens in millimetres. So that 6x30 means 6 power through a 30mm. objective lens and 7x50 is 7 power through a 50mm. lens, etc.
4. The golden rule is to be sure to consult United Technical Supplies when buying your binoculars, either by mail or in person, then you cannot go wrong.

For not only can we advise you on the suitability of binoculars for your purpose etc., but due to our vast range and extensive stocks we can guarantee absolute satisfaction at prices to suit all pockets. No binocular leaves either our showrooms or our mail order department unless it has been thoroughly checked and collimated at our optical works, as shown in illustration on right.



MB

## ROSS 7x50 EX NAVAL BINOCULARS



IN MINT CONDITON  
**COMPARE THESE WITH ANY OTHER  
 SURPLUS BINOCULARS OFFERED TODAY**

We have always specialised in the sale of first class optical equipment and we consider this binocular one of the finest glasses we have ever handled. Manufactured by Ross of London for the Admiralty, they are noted for their tremendous light gathering power and wide field of view. Their brilliant definition by day or by night has made them extremely popular with yachtsmen as well as a general purpose glass. Their Linear field of view is over 125 yards—1,000 yards. The ideal glasses for those who require the combination of Lightness, Sturdiness, Compactness and Performance.

**IN EXCELLENT CONDITION — ORIGINAL LIST PRICE £48 (approx.)  
 5 YEAR GUARANTEE**

**Our Price £19-10-0, Case 30/- extra**

Postage and Packing 3/6

or £3-15-0 DEPOSIT and nine monthly payments of £2-2-10 (incl. case).

**PART EXCHANGE.** We welcome the opportunity to part exchange your present binoculars for any shown in our catalogue.

**UTS UNITED TECHNICAL SUPPLIES LTD.**  
 MAIL ALL ORDERS TO  
 29 TOTTENHAM COURT ROAD, LONDON, W.1. LANgham 1116-1117-5015



# BINOCULARS



Admiralty Release  
GENUINE  
**BAUSCH & LOMB**  
NAVAL COMMANDERS  
7 x 50 BINOCULARS  
FULLY BLOOMED  
£26-0-0  
COMPLETE WITH LEATHER CASE  
5 YEARS GUARANTEE  
MAKER'S CURRENT PRICE £70

Genuine modern Bausch & Lomb, made to stringent Admiralty specifications. Without doubt, one of the world's finest binoculars. Unequalled for their brilliant day and night definition and unsurpassed penetrating power due to

exceptional high light transmissions produced by advanced optical system and precision coated optics. Perfectly balanced, they weigh only 2½ lbs. and are 7½" high. They have an extra wide field of 660 yards at 3 miles (approx.). Fixed focus characteristics ensures use at all distances without refocussing. Absolutely water and weatherproof. Price £26 CASH or £5. 4. 0. deposit and 12 monthly payments of £1 18. 2. Money back guarantee.

**PART EXCHANGE.** We welcome the opportunity to part exchange your present binoculars for any shown in our catalogue.

**Ex British Army Officers'**  
**6 x 30 BINOCULARS**  
By Leading British Makers  
**TAYLOR HOBSON, KERSHAW,  
WATSON-BAKER, etc.**

These precision-built British binoculars were originally made to stringent Government specifications for Army Officers' use. Consequently, they will stand up to a great deal of rough usage and are absolutely weatherproof. Individual eyepiece focussing and once focussed, they seldom need resetting. They are ideal for sporting events due to their crisp definition and high light transmission, birdwatching and general holiday use. Estimated value: £25. Dimensions: 6" x 4½". Weight: 28 ozs.

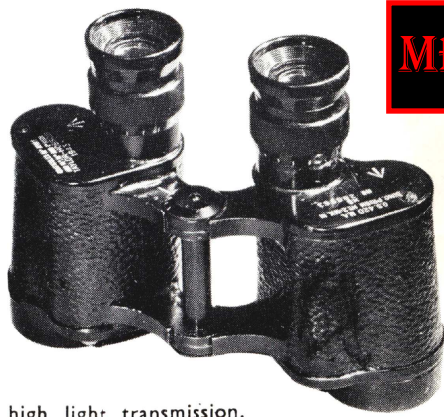

**Price £7-15-0**  
Postage and Packing 3/6  
New Hide Leather Case £1-0-0.

**COMPARE THESE WITH ANY OTHER SURPLUS BINOCULAR OFFER TODAY**

# BINOCULARS

**FULLY RECONDITIONED**

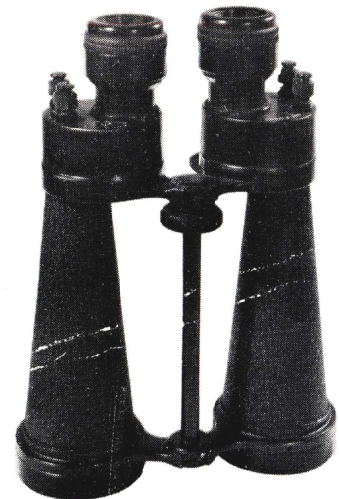

**Ex Admiralty Binoculars  
by BARR & STROUD**

**7 x 40 GENERAL PURPOSE  
SPECIALLY SUITABLE IN POOR LIGHT**

A General Purpose Binocular with high light transmission due to an original optical design. Comfortable to handle. Particularly suitable for use under conditions of poor visibility, by night, at sea or on land.

SPECIFICATIONS	
Magnification	7
Diameter of Objectives	43.7mm
Aperture of Objectives	42mm
Diameter of exit pupil	6mm
Field of view in degrees	7° 18'
Field of view in yards at 1,000	127 yds.
Height	7.7 ins.
Width	6.7 ins.
Weight (approx.)	2 lbs.

APPROX. LIST PRICE £42 **IN MINT**  
**OUR PRICE £22-0-0** **CONDITION**  
Including leather case

**COMPARE THESE WITH ANY OTHER  
SURPLUS BINOCULAR OFFER TODAY**

Postage and Packing 2/6  
Also available second hand but optically perfect £13-19-6d

## BARR & STROUD 7 x 50 BINOCULARS

Another Ex Admiralty binocular by this leading British Maker. Like the 7 x 40 above, but with wider objective lenses, it is ideal for all sporting and general purpose viewing, under almost any visibility conditions.

Complete with leather case

**FOR DAY and NIGHT USE  
BRILLIANT FIELD OF VIEW**

APPROX. LIST PRICE  
£47

SPECIFICATIONS	
Magnification	7
Dia. of objectives	50.8mm
Aperture of objectives	50mm
Dia. of exit pupils	7mm
Field of view in degrees	7°
Field of view in yards of 1,000	121 yds.
Height	9 ins.
Width	7 ins.
Weight	2½ lbs.



**Our Price** **IN MINT**  
**£25-0-0** **CONDITION**

Postage and Packing 2/6  
Also available second hand but optically perfect £13-19-6d

**COMPARE THESE WITH ANY OTHER SURPLUS BINOCULAR OFFER TODAY**



# BINOCULARS



YACHTING  
HUNTING  
FORESTRY  
NAVIGATION  
TRAVELLING

SPECTATOR SPORTS  
RACING  
TARGET SPOTTING  
EXPLORATION  
NATURE STUDY

AIRPORT CONTROL  
BIRD STUDY  
FIELD TRIALS  
MOUNTAINEERING  
NIGHT & GENERAL USE

Considered to be the finest 'All Round' Binocular of its type on the market today, it is guaranteed to give a life time of service due to the high standard of its optical and mechanical qualities.

### IMAGE QUALITY AND DEFINITION

Mere Magnification is of little use unless the image is sharp and well defined when magnified. The quality of image definition depends on the excellent standard of optical design, control of materials, precision of manufacture and correct assembly to design specifications. This instrument is noted for its maximum light transmission and Contrast, giving bright close up viewing of distant scenes, (free from distortion, curvature of field and chromatic aberration) with an extra wide field of view. Best results are obtained when mounted on tripod.

MAGNIFICATION: 12 times. Dia. OF OBJECTIVE LENS: 80 mm.  
FIELD OF VIEW AT 1,000 yards: 70 yds. (4%) EXIT PUPIL: 6.6 mm.  
RELATIVE BRIGHTNESS: 66.6

ABSOLTELY BRAND NEW - COMPLETE WITH  
SOLID HIDE VELVET LINED CASE  
**PRICE £60 - 0 - 0**  
(Including Tripod)

### Air Ministry Pattern Gallilean NIGHT BINOCULAR

Constructed to stringent service specification these glasses are ideal for Marine Observation and general use. They weigh only 28 ozs. and their magnification ( $2\frac{1}{2} \times 50$ ) makes them especially useful at night for astronomical viewing. Originally cost over £10.

**Our Price £5 - 5 - 0**  
(Including Case. Postage Free)

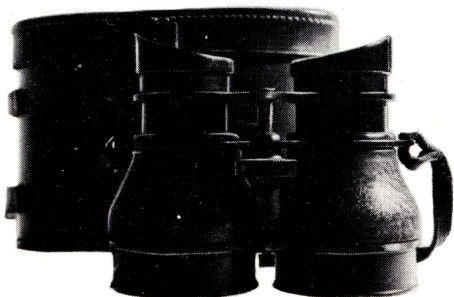

# LINDERMANN

12 × 80

## TRIPOD MOUNTING BINOCULARS

PRODUCT OF THE SAME SCIENTISTS AND CRAFTSMEN WHO PRODUCE OPTICAL LENSES AND PRECISION INSTRUMENTS FOR INDUSTRY, SCIENCE AND EDUCATION AUTHORITIES THROUGHOUT THE WORLD, THESE BINOCULARS WERE DESIGNED TO FULFIL EVERY REQUIREMENT.....

# BINOCULARS

## Ex Air Ministry 5 × 40 NIGHT BINOCULAR

Manufactured by ROSS, London.

Specially designed to give a wide field of view and high light transmission for use at night these prismatic binoculars have a fixed focus. This makes them not only ideal for general uses but invaluable for sporting events and all other instances where viewing distances are constantly and quickly changing.

Complete with Transit Case.

**£12 - 10 - 0**

Postage & Packing 2/6



### PART EXCHANGE

We welcome the opportunity to part exchange your present binoculars for any shown in our catalogue.

### BRAND NEW

## 8 × 25 BINOCULARS

Compact lightweight Sporting and General Purpose Binoculars by leading optical manufacturers. Magnification 8x, Diameter of Objective Lens 25mm., giving a field of view of 145 yards at 1,000 yards. Diameter of ocular ring 3.1 mm. Light gathering power 9.6.

**£7 - 15 - 0**

Case 25/- extra.  
Postage & Packing 2/6

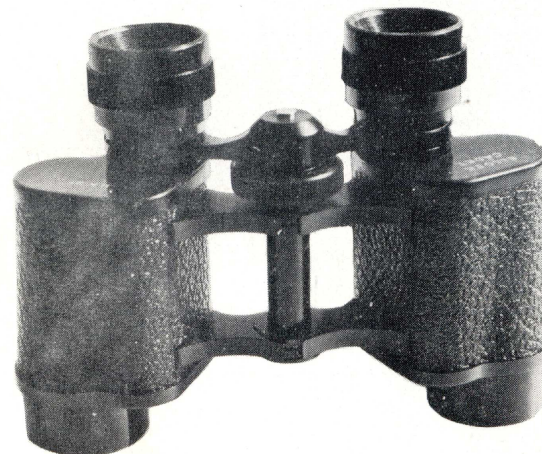



## BINOCULARS

### NEW ROSS BINOCULARS

ROSS OF LONDON

ROSS of London have long been associated with top quality optical instruments and we have specially selected these instruments from their comprehensive range



#### SOLAROSS 9 x 35

Super lightweight. Ultra Modern Design with centre wheel focussing and bloomed lenses. Weight 21 oz.

#### PRICE £19-15-4

Complete with leather case  
Postage and Packing 3/6  
OTHER SOLAROSS MODELS

7 x 42 ... £25-15-4  
12 x 40 ... £26-0-4  
15 x 40 ... £29-0-4

Spectacle Solaross  
8 x 35 £28-10-4

#### ROSS-ENBEECO

13 x 60

A high efficiency, central focussing prismatic binocular with special coated optics for better vision. A good choice for those who require high power.

With an exit pupil of 4.6 mm. and the extremely large 60 mm. object glass the linear field of view is 67 yards at 1,000 yards.

#### PRICE £33-16-8

Complete with leather case

Postage and Packing 3/6



ALSO AVAILABLE FROM THE ROSS RANGE

Model	Magnification and Object Glass Dia.	Price
Ross Stepsun	12 X 50	£57-14-11
Ross Stepmur	10 X 50	£56-17-8
Ross Stepflux	7 X 50	£52-9-8
Ross Stepruva	9 X 35	£38-13-4
Ross Steptron	8 X 30	£36-10-9
Spectaross	8 X 40	£47-11-4
Tropical 7	7 X 42	£53-18-8
Tropical 10	10 X 50	£62-16-8

## BINOCULARS

6 x 30

### BAUSCH & LOMB and CANADIAN NAVAL BINOCULARS

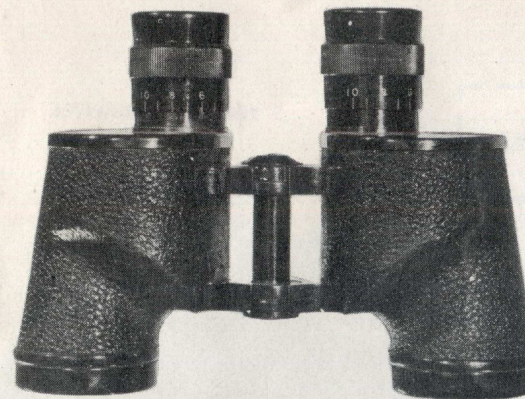

Made to stringent Canadian and U.S. Navy specifications by Bausch & Lomb, the Universal Camera Corp. of New York, and Research Enterprises of Canada, these excellent binoculars are of modern American design. Brilliant definition and large field of view (150 yards at 1,000 yards) make them ideal for use by day and by night. They have individual eyepiece focusing and depth of focus is unusually great. Their beautifully streamlined construction makes them a joy to handle. Would cost approx. £30 today.

COMPLETE WITH LEATHER CASE

Postage and Packing 3/6

Our Prices :—

BAUSCH & LOMB £12-10-0

REL/Canada & UNIVERSAL CAMERA CORPN. £10-15-0

#### PART EXCHANGE

We welcome the opportunity to part exchange your present binoculars for the latest models.

### Ex-Government RECONNAISSANCE BINOCULARS by ROSS

A sturdy Day and 'Night glass with fitted Yellow filters for use in haze and bright conditions. Built to stringent government specification for service use. Tripod supported. Magnification 7x. Nett Weight: 16 lbs. Contains two Achro doubles f:210mm. 50mm. clear aperture, two Porro Abbe prisms, left hand 25mm. aperture, and two right hand. Two Plano-convex lenses 25mm. diameter L.H. and R.H. (with cross graticule, two Achro doublets f:39mm. 26mm. clear aperture.

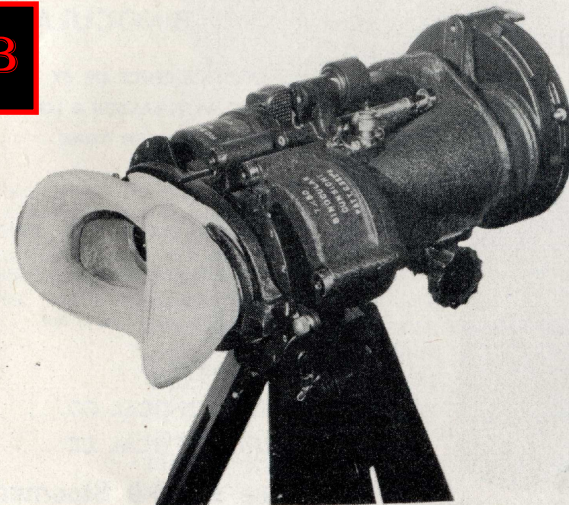

COMPLETE WITH WOODEN CASE AND TRIPOD

Price £19-10-0

Including carriage

ORIGINAL COST APPROXIMATELY £150

MB



## BINOCULARS

FIRST ADMIRALTY RELEASE  
**10 x 70 BATTLESHIP BINOCULARS**  
 by ROSS, LONDON

5 YEARS GUARANTEE

SPECIALLY SUITABLE FOR  
 LONG DISTANCE VIEWING  
 FOR TRIPOD MOUNTING

These super naval binoculars have an extra large field of view and wide angle. They are fitted with sun covers and three filters: light Neutral, Dark Neutral, and Russian Yellow. Their 70mm objective lenses and extra power make them ideal for use in practically any visibility condition on land as well as at sea. They have brilliant light gathering power and the individual eyepiece focussing gives an extra sharp image at a long range.

APPROX. LIST PRICE £150

**Our Price £50-0-0**

IN MINT CONDITION  
 (Complete with Tripod)

A few available in good optical condition

**£37-10-0**  
 (without Tripod)

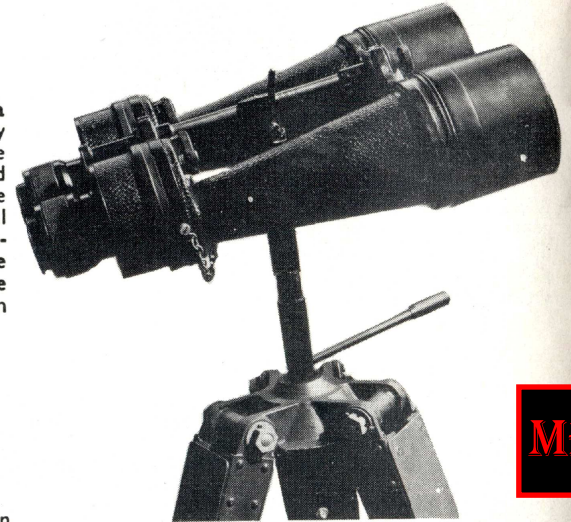

Hire Purchase Terms on application

## Ex-Admiralty 7 x 50 BINOCULARS

MADE UNDER LICENCE OR BY  
 ARRANGEMENT WITH BAUSCH & LOMB  
 OF ROCHESTER, NEW YORK

These binoculars are of similar construction but identical optical specification to the genuine BAUSCH & LOMB 7 x 50 binoculars shown earlier in this catalogue. They are in perfect condition and are complete with straps and leather cases. 5 years Guarantee.

MAKERS  
 SPENCER OPTICAL CO.  
 ANCHOR OPTICAL CO.

**Our Price £24-0-0 Bloomed**

Complete with leather case  
 Postage and Packing 3/6



## MONOCULARS

### Ex Admiralty TELESCOPE

by Kodak of Canada

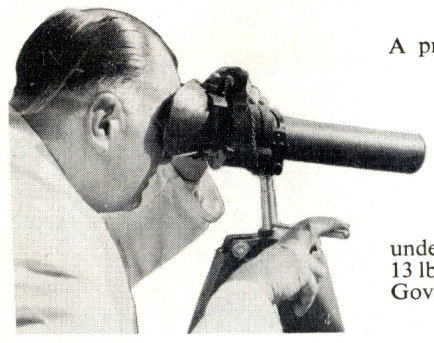

A prismatic telescope made to Admiralty specification. Ideal for Lunar and Planetary observations as well as terrestrial uses, it is a 7 x 50 instrument fitted with binocular rubber eyepiece guard (with "cut out" for left eye) and filters enabling it to give a superb performance under almost any condition of visibility. Weight: 13 lbs. (excluding tripod). Estimated cost to Government: £120.

**OUR PRICE £9-15-0**

(Including Tripod)

## Extra Wide Angle 10 x 80 PRISMATIC TELESCOPE SUITABLE FOR TRIPOD MOUNTING

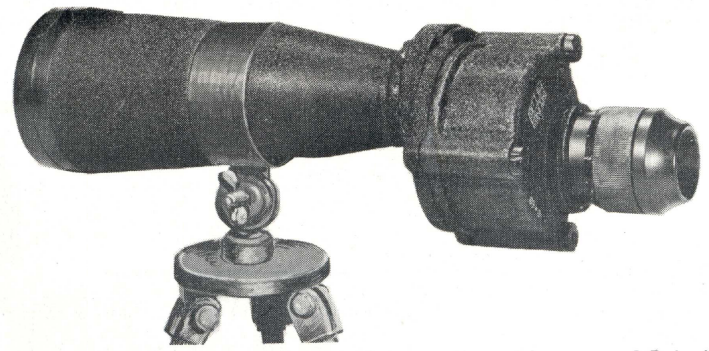

This fine instrument has only just been released by one of Britain's leading Optical manufacturers.

It is sturdily constructed and contains a composite prism erector system that is only found in the more expensive telescopes. The 80mm. clear aperture Achromatic objective lens has a maximum light intake. This gives an outstanding image sharpness and unequalled contrast and brightness in an extra wide field of view ideal for spotting, birdwatching and general long range observation, sightseeing, etc.

**PRICE £27-10-0**

TRIPOD £2-10-0

Postage and Packing 5/-



## MONOCULARS

### The 'LINDERMANN' SPOTSCOPE

20 Power

#### POCKET MONOCULAR

A super light-weight prismatic spotter scope. Can easily be carried in the pocket at all times and will provide hours of unexpected pleasure that only "close-ups" can give. Specially quick micrometer focussing 20 power. 43 mm. object glass.

Length 6½ inches. Weight 9 ozs.

Price £5-17-6

Postage and packing 2/6  
Velvet lined leather case 20/-



#### 10x and 20x MONOCULARS

This high quality Monocular is made exclusively for U.T.S. by a leading British Manufacturer. Compact, lightweight instrument with bloomed optics for maximum light gathering power. Micrometer eyepiece focussing. Available either 10 x 50 or 20 x 50.

Length 6½ inches Weight 12 ozs.

Price £7-10-0

Postage and Packing 2/6

Velvet lined leather case 20/-



#### ROSS, London

#### 7 x 50 MONOCULAR

This instrument is noted for its excellent light-gathering power and wide field, providing excellent vision at all times even at night or in fading light. In as new condition. Superb value at this price.

Our Price £8-15-0

Postage and Packing 2/6

Lined English leather case £1-0-0 extra



MB

### "SUPERVUE" HIGH POWER MONOCULARS

10 x 50, 12 x 50 or 15 x 50

Made in this country to stringent Lindermann specifications. Designed to provide extra power without sacrificing field of view or causing extra weight. Ultra-modern design, bloomed lenses. Ideal for birdwatching, sporting events and general viewing. At a price to suit all pockets.

A choice of three sizes: 10 x 50, 12 x 50 or 15 x 50  
To suit individual requirements.

Price £8-10-0

Postage and Packing 2/6  
Lined English Hide leather case £1-0-0.

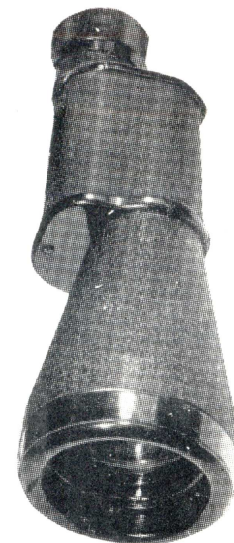

Ex. Govt.

#### 6 x 30 MONOCULAR

by Taylor Hobson, Kershaw, etc.

Light and convenient for the pocket, being only 5" high and weighing 9 ozs. High quality construction, will stand a considerable amount of rough usage.

Price £4-10-0

Postage and Packing 2/6



### BARR & STROUD MONOCULARS

7 x 40 or 7 x 50

Made by one of Britain's leading optical manufacturers these 7 power general purpose monoculars are noted for their high light transmission as they were specially designed to produce results under poor visibility conditions. Available in two sizes with either 40 mm. or 50 mm. objective lenses.

Prices { 7 x 40 £9-15-0  
7 x 50 £10-15-0

Postage and Packing 2/6  
Lined Leather Case £1-0-0 extra



## MONOCULARS





**AMERICAN NAVAL TELESCOPES**

16 Power ex U.S. Navy telescope of the highest quality. 2½" diameter object glass gives maximum clarity and wide field of view. Brilliant definition can be obtained with the graduated eyepiece focusing system, Length 30". Weight 12lbs.

**Our Price £11 - 15 - 0**

Tripod £1 - 0 - 0 extra

**LINDERMANN "RANGEMASTER"**

A 22 Power Prismatic Telescope with a 50 mm. Objective Lens. An instrument of superb performance under all conditions, it is favoured by Bird Watchers, Astronomers and general viewers as well as being widely used for Range Spotting. It has micrometer eyepiece focusing and the composite prism assembly gives extra light and brilliant definition over all distances. Field of View at 1,000 yards: 25 yards. Angle of View: 1° 25 minutes. Exit Pupil 2.2 mm. Weight approx. 4½ lbs.

**£22 - 10 - 0**

Including Tripod



**ROSS 10 x 70 MONOCULAR**

This monocular is fitted with three filters: Yellow, Light Neutral and Dark Neutral which together with its 70 mm. objective lens, precision eyepiece focussing and an excellent prism system, make it ideal for use under almost any condition of visibility on land or at sea.

Although originally designed for long distance viewing, it is noted for its extra large field of view and wide angle and gives an extra sharp image at all ranges. Ideal for Photograph, Birdwatching and General Purpose viewing.

TODAY'S VALUE OVER £75

**OUR PRICE £22 - 10 - 0** Postage and Packing 5/-  
Ex Government Tripod available £2 - 10 - 0

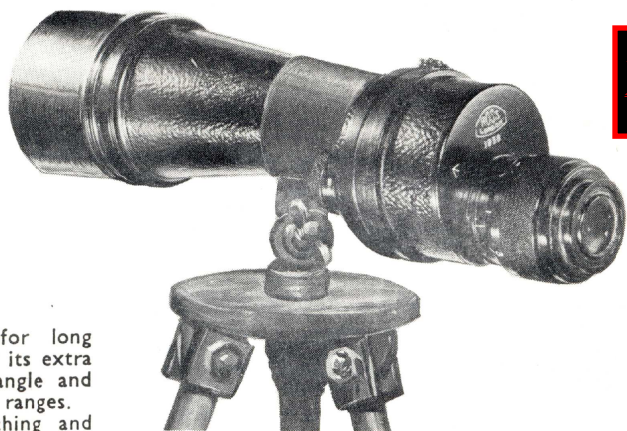

**MB**

**Ex ARMY THREE DRAW RECONNAISSANCE TELESCOPE**

**IN MINT CONDITION**

List Price £20

**OUR PRICE**

**£8 - 15 - 0**

Complete with Brand New Leather Sling Case



This 25 power signalling telescope was originally issued to the Intelligence Corps. It extends to a length of 30 inches and conveniently closes down to 11 inches. The diameter of the object glass is 2" and the weight 2 lbs. The unequalled definition, compactness and tropicalised body construction, make this an ideal instrument for all purposes, from shooting to amateur astronomy.

**THE HERTEL & REUSS 'TELE-VARI'**

**BRAND NEW MULTI-PURPOSE TELESCOPE WITH FIVE MAGNIFICATIONS**

25x 30x 40x 50x 60x

**£39 - 8 - 6**

Complete with leather case

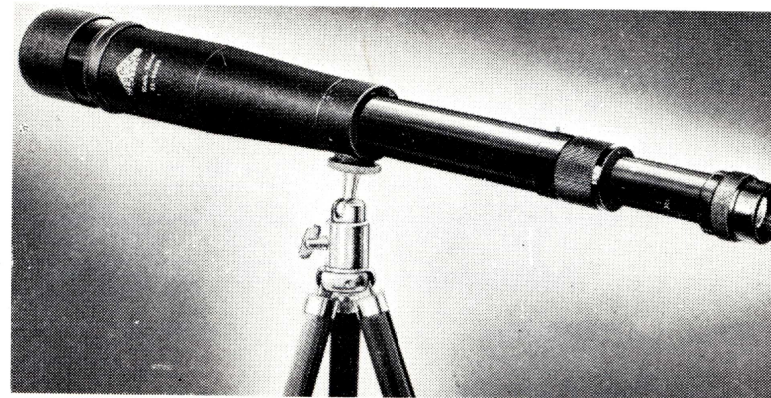

A high precision instrument for Astronomy, General uses, and especially for checking buildings, bridges, high tension wires and all other objects which cannot easily be reached or are of long range. It has an 18 mm. diameter eyepiece and a 60 mm. objective lens.

TRIPOD £6 - 0 - 0

Magnification	Exit-Pupil	Luminosity	Dawn power	Field of view at 1000 m.
25x	2.4	5.8	38.73	23.3
30x	2	4.0	42.43	23.3
40x	1.5	2.3	48.99	20.0
50x	1.2	1.5	54.77	16.5
60x	1	1.0	60.00	14.7



**SIGHTS**

**2x TELESCOPIC SIGHT M.38**

An excellent **Ex.-Govt.** Sight, strongly constructed. Only 5½" in length and 1¼" dia. Weight 1 lb. 6 ozs. Ideal for all calibres. Objective: Achromatic Triplet Focal length 53mm. Dia. 24.5 Part cemented GRATICULE: Wide and short horizontal lines numbered 1, 2 and 3. 2 Porro Abbe Left Hand Prisms 18 mm. long 9 mm. wide uncemented, mounted in cradle 20 mm. dia. EYEPIECE: Achro Doublet Focal length 80mm. Diameter 12mm.

**Price £2-5-0**  
Postage and Packing 2/6



**RIFLE SIGHT No. 42**

Good luminosity combined with outstanding definition are the main features of this **Ex. Government** sight. It is absolutely weatherproof and is suitable for all calibres from .22 to .303. Magnification 3½x. Eye relief 3", Body Tube Dia. 1", Weight 17 ozs., Length 11", Eye Lens dia. 1⅜". Object glass dia. 1⅜". Single line graticule.

**Our Price 45/-**  
Postage and Packing 2/6

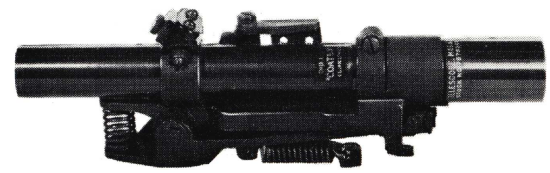

**TELESCOPIC SIGHT M.45**

A solidly constructed sight with 2x magnification. The body tube is 7⁄8" dia. and the object glass ⅜". Weight 10 ozs., Eye relief 3". The Graticule has short vertical and horizontal graduations. **Ex. Government, IN NEW CONDITION.**

**Our Price 45/-**

**x3½ PRISMATIC ELBOW TELESCOPE**

by **ROSS & OTTWAY, LONDON**

Containing: Achro. Doublet, F: 60 mm. clear aperture 15 mm. wide, Graticule, plain cross on disc 16.5 dia., in threaded cell. Two Achro. doublets F: 38.2 mm. dia. making an eyepiece 19.5 mm. focal length. Total weight: 1 lb. 12 ozs. Magnification x3. The high degree of accuracy incorporated in this instrument, i.e., the Cross Graticule and large field of view, make this an ideal instrument for conversion into an optical level.

**Price £4-15-0**

Postage and Packing 2/6

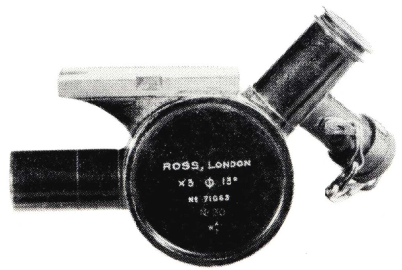

Also available:—Ottway, with focussing eyepiece £5-15-0. P. & P. 2/6.

**SPECIAL TELESCOPE OFFER**

**'THE SCOUTER' 25 POWER  
ARMY PATTERN  
General Purpose Telescope**

Made exclusively for U.T.S. and based on the famous "Scout Telescope", as used by the British Forces in World War II.



**SUPER  
LIGHTWEIGHT**

**FULLY  
BLOOMED  
LENSES  
THROUGHOUT**

**PRICE £8-15-0**

Postage and packing 2/6.

A truly remarkable instrument for the price, this 3-draw telescope is beautifully finished in English chrome leather. The lenses are fully bloomed throughout, and all metal parts are anodized. The magnification is 25 times and through the 52mm. objective lens this gives an extra wide clear picture with excellent light value. It is extremely light and compact; weighing less than 2 lbs. it is 34" long when extended and closes down to only 11½".

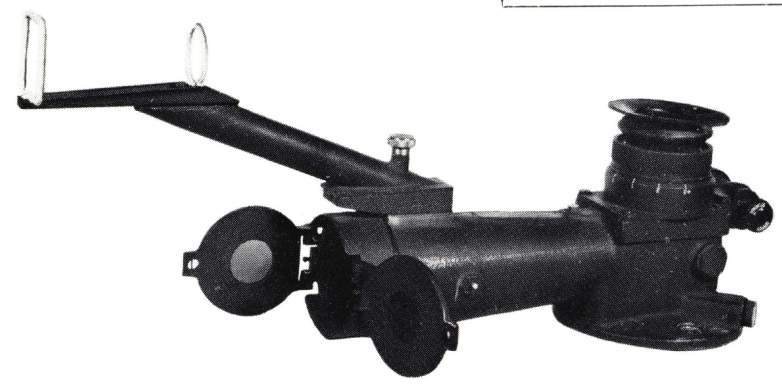

**ELBOW TELESCOPE No. 14 by Cooke, Troughton & Simms**

Ideal for taking bearings on stars, moonwatching, etc., this instrument was originally constructed as a sighting telescope. It has a Helical Focussing Eyepiece, illuminated graticules and built-on filters. Complete with sighting unit. Sturdy construction. In excellent condition. First class optical components.

**Price £6-10-0**  
Postage and Packing 5/-



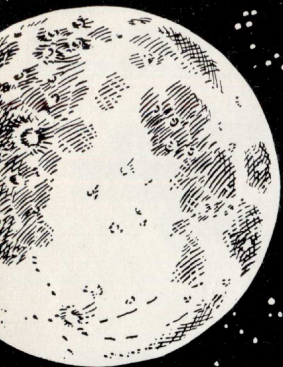

# Starmaster

"MARK II"

## 4 inch REFLECTOR BUILD IT YOURSELF KIT

**READY GROUND MIRROR  
WITH TOP QUALITY  
COMPONENTS**

**EASY TO  
ASSEMBLE**



**FOR ALL  
AGES**

**Exceptional  
Educational  
Value**

The Kit includes a finished 4" spherical mirror and diagonal flat, both optically worked and aluminised, plus a microscope eyepiece giving a magnification of 31 times on this instrument. The finished article is light but sturdy, on a wooden altazimuth mounting to enable free movement in both horizontal and vertical plains. Complete with instruction booklet containing sky charts. Since commencing production on this instrument in early 1957, the manufacturers have made many improvements to its design and to the quality of the optical and other components. This will guarantee a longer life and even better viewing.

**£6-17-6**

Postage and Packing 5/-

Additional 78x Eyepieces for increased magnification: £2-5-6  
The "Starmaster" can be supplied completely assembled and ready for use at £11-17-6.



### JOURNEY into SPACE

The Starmaster was originally designed to comply with the increasing current demand for an Astronomical Telescope to suit the requirements of both beginner and expert at a price within reach of all pockets. However, during the short time it has been on the market, not only has it been a great success with Astronomers, but photographers too. One of the leading photography magazines, "35 mm. Photographing" published an interesting article by K. N. Harris entitled "Journey into Space" in their October 1960 issue. This shows how results (illustrated on right and overleaf) were obtained by photographing the moon with a Retina Reflex Camera, fitted with the standard 50 mm. f/2.8 Xenar lens, in conjunction with the Starmaster Telescope, using the 31 power eyepiece. By adjusting the camera tripod so that the camera lens is closed to the telescope eye-piece in a straight line and at right-angles to the centre line of the telescope tube, correct focus is obtained merely by adjusting the telescope eyepiece. The camera lens being focussed at infinity and opened to its maximum aperture plays no part in the formation of the image.

#### LENGTH OF EXPOSURE

This depends on the speed of the emulsion employed, phase of the moon and weather conditions, i.e. 1/30 sec. exposure on medium-speed film is satisfactory with a full moon in good viewing conditions. But during the first or last quarter of the moon (when only half of its face is illuminated), 1/8 sec. exposure is necessary with similar film and conditions. The illumination fall-off is explained by the fact that in the latter condition, the light, which originates from the sun, is being reflected at 90° instead of being returned almost parallel to its original direction (as at full moon). Likewise, the crescent moon would require not less than 2 secs. on medium speed film. Faster emulsions can be used to reduce times proportionally, i.e. a 400 ASA film allowing a 1/2 sec. exposure in the case of the crescent moon. The aim is to keep exposure time to absolute minimum for much the same reason that high shutter speeds are used with action subjects, for

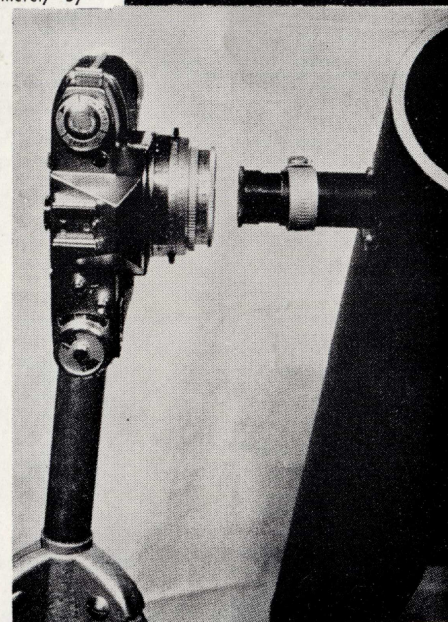

although the moon seems stationary it is nevertheless constantly in motion in relation to earth — and telescopes. The Starmaster's field of view with the standard 31 power eyepiece, is a little over two diameters of the moon's disc, and the moon will pass completely across the field of view, from edge to edge, in approximately four minutes and ten seconds.

#### FLASH OF A METEOR

Having attempted this form of photography, photographers are finding Astronomy an engrossing second hobby. Having obtained good sharp close-ups of the moon in monochrome, they are trying again with the new high speed colour reversal films, as projected transparencies in natural colour are most impressive. There are other things to shoot with a telescope besides the moon, for instance the capturing of the flash of a meteor as it streaks across the sky, or when bigger and better satellites are in orbit, you will be able to record their tracks as they move against a backdrop of near-stationary stars.

**UNITED TECHNICAL SUPPLIES LTD.**  
29 TOTTENHAM COURT ROAD, LONDON, W.1. LANGHAM 1116, 1117, 5015



## ASTRONOMICAL TELESCOPES

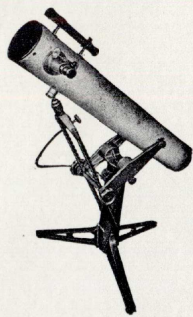

**THE "ORION" 6 inch f8  
NEWTONIAN ASTRONOMICAL  
TELESCOPE**

A new design that has been proved to be the finest of its type offered in England today, capable of very serious work and of accommodating very high magnification if necessary. It consists of an impregnated laminated plastic tube, with a cork mounted aluminised parabolic mirror which has been polished to  $\frac{1}{4}$  of a waveband, an aluminised diagonal  $\frac{1}{4}$ " thick, the minor axis being  $1\frac{1}{2}$ " and an eyepiece unit that has rack and pinion fine focussing for a length of 1 inch plus a draw tube for quick positioning when changing power. Designed to take the American type 1.250 inch diameter eyepieces it also has a simple screw adapter for conversion to English standard screw fitting of 1.250 inch diameter x 16 t.p.i.

The Orthoscopic eyepiece of 0.766" (19.5mm) focus, with the 48" focus primary mirror, gives an approx. magnification of 60x. Eyepieces of other powers and types can be supplied for use on this instrument. It has a light, robust and easily handled azimuth mount, and the Finder, which is mounted on the main tube, has an adjustable crosshairs graticule.

PRICE £175-0-0

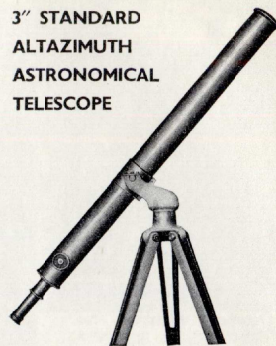

**3" STANDARD  
ALTAZIMUTH  
ASTRONOMICAL  
TELESCOPE**

This Telescope is fitted with a 3" good quality object glass of 40" focal length without squaring on adjustment, and the eye piece is of the usual pull-out variety with rack and pinion focussing. One astronomical eyepiece of 70x is supplied complete with dark glass head. It is carried in trunnion bearings and supported by a forked member, provided with azimuth rotation. The tripod is of the split leg type, of good quality hardwood, fitted with stretcher chain and metal toe pieces. The telescope is finished in white stove enamel with brass parts nickel plated and the stand head finished black stove enamel.

PRICE £53-11-0

MB

## OPTICAL PARTS FOR THE ASTRO TELESCOPE BUILDER

**4" MIRROR & DIAGONAL FLAT**  
Focal length 31" Both Aluminised £3.

Price £11-10-0

**6" MIRROR & ELLIPTICAL FLAT**  
Focal length: 48" Both Aluminised Parabolised mirror. Low expansion Pyrex glass 1/4 wave. Minor Axis.

Price £11-10-0

**7 $\frac{3}{4}$ " MIRROR & ELLIPTICAL FLAT.**  
As above but with 64" focal length and minor axis of 1.9".

Price £19-10-0

Balsamed, unmounted. Focal length: 35 $\frac{1}{2}$ ".  
Price £10-0-0

Anodised Mount £2-5-0

Balsamed, unmounted. Focal length: 47"  
Price £20-0-0

Anodised Mount £3-0-0  
For moon and star finders,

Thousands of Unclassified Lenses are available

at our Optical Showrooms at 29 Tottenham Court Road, London, W.1. LANGHAM 1116, 1117, 5015

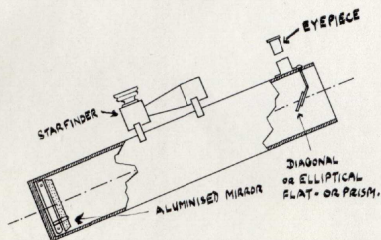

**3" CLEAR APERTURE  
OBJECTIVE LENS.**

**4" CLEAR APERTURE  
OBJECTIVE LENS.**

## EX-SERVICES SELF ILLUMINATING MAP MAGNIFIER

Indispensable for

PHILATELISTS	draughtsmen
ENGRAVERS	PHOTOGRAPHERS
ANTIQUÉ COLLECTORS	JEWELLERS
	DESIGNERS, etc.

and a MUST  
FOR ALL RALLY DRIVERS

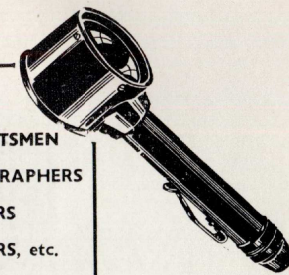

Romer-marked Glass and Rheostat controlled for dimming light. The ideal magnifying glass for rally drivers. Philatelists, etc. Uses normal torch batteries and bulbs. Offered complete with batteries plus 4 spare bulbs.

OUR PRICE 35/-

TODAY'S  
APPROXIMATE COST  
(IF OBTAINABLE) £5  
Postage and Packing 2/-

Service Pattern

## LIQUID PRISMATIC COMPASS

Stout Hinged Brass Case, external diameter 2". Engine divided to 64 Compass Points. Prism Holder with focussing arrangement. Compass Interior Box contains a transparent edge dial, divided to single degrees, mounted with sapphire centre floating to liquid on an iridium point, also a trough containing radium compound and a patent bubble trap. Transparent Rotary Scale divided every 5° and figured every 10°. Its steadiness makes it a perfect compass for Geologists and Surveyors or for taking bearings from Boats, Cars, Aircraft, etc.

Manufacturer's Cost Today £14

Our Price £3-18-6

Postage and Packing 2/6  
Leather Sling carrying case, 11/6 extra.



## E2A CAR COMPASS IN CURRENT USE IN JET AIRCRAFT

The ideal car compass, noted for its accuracy and steadiness under all conditions, with vertical card presentation and calibrated every 10°. It is liquid filled and gives a direct reading at any angle. The built-in correctors provide correction for co-efficients B and C. Very popular with gliding enthusiasts and motorists. Cost the Government over £10.

Our Price £2-15-0  
Postage and Packing 2/-

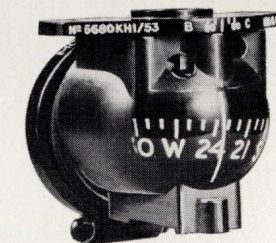



**SWISS 1/10th second STOPWATCHES**

Ex Govt. Unissued. Perfect. 12 Months written guar. We offer these excellent stopwatches at a fraction of their cost price, and consider them to be the finest of their kind obtainable. Top quality jewelled lever movements by leading Swiss manufacturers. Crown operated with 30 second dial with inset minute recorder. An outstanding offer at this price.

**£4. 15. 0**

Plus 2/- post/pkg.

Also available (as above)

★ SMITHS 1/10th second Brand New Stopwatches **£3. 10** plus 2/- post/pkg.

★ SWISS 1/5th second Stopwatches **£4. 5** plus 2/- post/pkg.

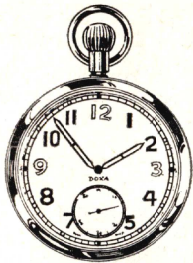
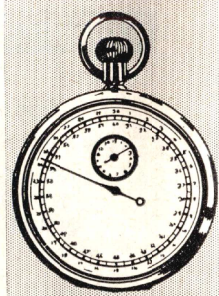

**'DOXA' POCKET WATCH**

This Swiss precision, 9 jewel pocket watch, made to stringent Government specifications, is one of the higher quality movements available today. Issued only to Service Personnel engaged on duties involving precision time-keeping. Breguet hairspring and compensating balance. In brand new condition. Offered at a fraction of original cost. 12 months written guarantee. 7 day approx. Refund guarantee.

**OUR PRICE £3. 15. 0**

plus 2/- post/pkg.

**UTS**

**BRITAIN'S GREATEST OPTICAL & SCIENTIFIC CENTRE**

**MB**

**UTS**

A selection of interesting **CHRISTMAS GIFTS**

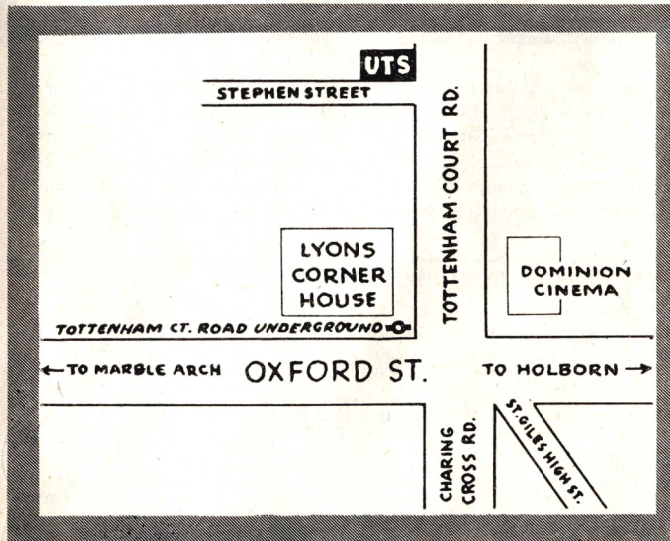

Our main Showroom at 29 Tottenham Court Road, London, W.1 (see plan above) is open all day Saturdays, and until 1 p.m. Thursdays.

The following FREE catalogues are available on request:—

- (A) BINOCULARS, TELESCOPES, SIGHTS, ETC.
- (B) WATCHES, STOPWATCHES and CLOCKS
- (C) MICROSCOPES, GRATIQUES and MAGNIFIERS

Callers are welcomed at our Showrooms by experienced staff. Very many other interesting items available.

**UNITED TECHNICAL SUPPLIES LTD.**

29 TOTTENHAM COURT ROAD, LONDON, W.1.

LANgham 1116-1117-5015

**UNITED TECHNICAL SUPPLIES LTD.**

BRITAIN'S LEADING SCIENTIFIC CENTRE



**ARMY MARCHING COMPASS**

Genuine Service issue for field work and reconnaissance.

IDEAL FOR SCOUTS, HIKERS, CYCLISTS, ETC.

Graduated 0-360° in 5° divisions. Lid fitted with metal reflecting surface. When lid is opened, the target can be sighted and compass read simultaneously. Rotating Dial, 1 3/4" diameter. Case, 2" x 2". Weight, 5 ozs.

**PRICE 15/-**

Plus 2/- post/pkg.

**LATEST SERVICE PATTERN**

**OFFICERS' LIQUID PRISMATIC COMPASSES**

**£3. 18. 6**

Plus 2/- p/p.



Beautifully made with stout, hinged brass case. External transparent rotary scale divided every 5 deg., figures every 10 deg. Interior contains a transparent edge dial divided into single degrees, mounted on a sapphire centre which floats in liquid on an iridium point. This remarkable compass has a steadiness which makes it ideal for taking bearings from boats, cars, aircraft, etc., and in the field. TODAY'S VALUE £14.

Leather Sling Case 11/6 extra

**DRAWING INSTRUMENTS BRAND NEW**



Lined leather case with bolt fastening. Comprising: 2 Dividers, Ink and Pencil points and spare knee-jointed arm. Set of 3 Spring Bows. Drawing Pen plus spare handle, spare leads and adjusting screw.

**35/3**

Other sizes 18/9, 23/6, 30/3 & 70/-, plus 2/- post/pkg.

**E. 2A CAR COMPASS**

As used in Jet Aircraft

Made to stringent Govt. specifications the E. 2A is an ideal Car Compass. It is liquid filled and gives a direct reading at all angles. With built-in compensated correctors, it is noted for accuracy and steadiness under all conditions.

Manufacturer's original price, over £10.



**55/-**

Plus 2/- post/pkg.



OPTICAL  
FIRST CLASS  
COMPONENTS

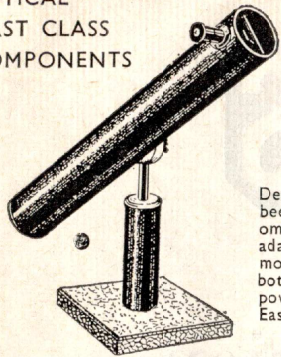

*Starmaster*

**4" ASTRONOMICAL  
TELESCOPE KIT**

AN IDEAL PRESENT FOR ALL AGES

Designed for beginner and expert, the Starmaster has been a great success. Universally accepted by Astronomy enthusiasts. Photographers have found that simple adaptation achieves amazing results photographing the moon, etc. Kit includes: 4" Mirror and Diagonal Flat, both optically worked and aluminised. Microscope 31 power eyepiece. Light, sturdy altazimuth mounting. Easily assembled.

PRICE **£6. 17. 6**

Plus 5/- post/pkg.

Additional 78 x eyepiece for increased magnification  
**£2. 5. 6**

**The 'SCOUTER'**

GENERAL PURPOSE ARMY PATTERN



**25 POWER**

Beautifully finished in English chrome leather, this 3 draw telescope is ideal for all occasions: sailing, ornithology, astronomy, etc. 52 mm. object glass, fully bloomed lenses. Anodized metal parts. Length 34" open, 11 1/4" closed.

Weighs less than 2 lbs.

**TELESCOPES**

**BRAND NEW**

PRICE **£8. 15. 0**

Plus 2/6 post/pkg.

Also available:

Genuine Army Scout

Telescopes

(same specification)

**£8. 15. 0** p/p. 2/6

BRITAIN'S FINEST BINOCULAR BARGAIN!

**The LINDERMANN**

'SUPERVUE' 12 x 50

**BRAND NEW**

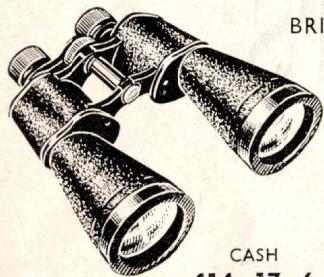

CASH

**£14. 17. 6**

2/6 post/pkg.

HIDE CASE 30/- extra

or **£4 DEP.** plus 2/6 p/p.  
and 9 monthly payments of  
**£1. 12. 3** (incl. case)

These splendid ultra-modern binoculars are made in Britain to stringent Lindermann specifications. Sturdy but light, with a wide field of view, extra power, centre focusing and coated optics, they are ideal all round binoculars. Grand for yachting, sporting events, holidays, etc.

**MB**

EX ARMY OFFICERS'

**6 x 30 BINOCULARS**

IN ABSOLUTE MINT CONDITION

Precision built for the Services to stringent Government specifications, by such famous makers as Taylor Hobson, Kershaw, Watson Baker, etc. Sturdy, waterproof, with individual eyepiece focusing. Their crisp definition and high light transmission make them ideal for sporting events, birdwatching and general holiday use.

6" x 4 1/4". Weight 28 ozs.

Estimated replacement value **£25**

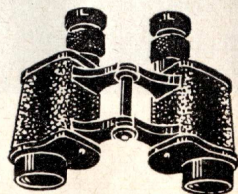

**£7. 15. 0**

Post/pkg. 2/6

New Hide Leather Case  
**£1** extra

**UTS**

A SPECIAL SELECTION FROM  
OUR WIDE RANGE OF HIGH QUALITY:—  
BINOCULARS, TELESCOPES, MICROSCOPES,  
STOPWATCHES, WATCHES & CLOCKS,  
DRAWING EQUIPMENT, LENSES, PRISMS,  
OPTICAL & SCIENTIFIC EQUIPMENT, ETC.

Here is a selection of useful and interesting items from our very wide range of new and Ex Government stocks, that can solve your Christmas Gift problem. We are able to offer them at very keen prices due to bulk purchasing from Government Departments, and other markets throughout the world. All goods are completely checked, timed and fully guaranteed before release.

**The 'NATURALIST' MICROSCOPE**

Magnification 50 x to 150 x

With Polaroid for glorious colour

BY  
**BRITEX**

This is a soundly designed microscope, well constructed with sturdy zinc alloy and duralumin. It has top quality optical components, is easy to use and simple to adjust. Built-in (cycle battery) illumination. At this moderate price it is ideal for home study for young students of natural history, botany, etc.

PRICE Plus  
**£5. 5. 0** 3/6  
post/pkg.  
Battery 1/6 ex.

Complete with battery and one plain slide. Boxes of slides (insect parts) for beginners in three sets of 12 slides, all different—**15/-** per set, p/p. 2/- ex.

Also:  
Microscope Kit & Book 'World Within a World' **15/6** plus 2/6 p/p.

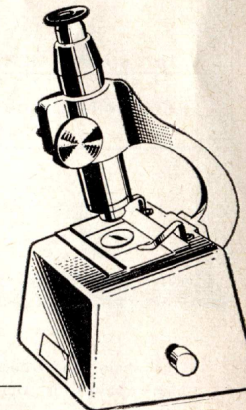

By **BRITEX**  
**Zoom**

Magnification  
50 x to  
350 x

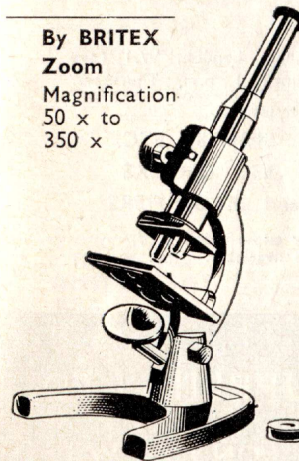

**PIONEER II  
MICROSCOPE** with **POLAROID**

A unique, scientifically constructed microscope with telescopic draw tubes, each with a selection of filters in a sub-stage rotator. One of these consists of a special polarising material, which when used with the abalysing eye-cap, produces amazing results, as different colours will be seen according to the make-up and thickness of the specimen.

Height: (fully extended) 10" (closed) 7"  
Stage dimensions 2 1/4" x 2 1/4"

In stout box, complete with Polarising attachment and special crystal slide.

**£6. 19. 6**  
2/6 p/p

3 sets of 12 slides (all different) of Insect and Spider parts.

15/- per set 2/- p/p.  
Also: Microscope Kit & Book 'World Within a World' **15/6** plus 2/6 p/p.

**UNITED TECHNICAL SUPPLIES LTD.**



Choose one of these famous names

OMEGA or  
INTERNATIONAL  
MINISTRY OF AVIATION  
NAVIGATIONAL  
WRIST WATCHES



These world-famous watches made to stringent Government specifications will give a lifetime of service with split second accuracy. The Swiss high precision 15 jewelled lever movement (13 ligne) with compensated balance and Breguet hairspring, is one of the finest timepieces ever issued to the Forces. Sturdy, stainless steel, water-resistant screw back case and night dial. 12 month written guarantee. 7 day appro. Money refund guarantee. Estimated replacement value over £30. Also available: ETERNA, JAEGER LE COULTRE and LEMANIA (same specification) £9. 18. 6 2/6 p/p.

OUR PRICE  
£12. 18. 6  
plus 2/6 post, etc.  
or £3 DEP. & 9  
monthly payments of  
£1. 6. 6

GENUINE EX AIRCREW  
WRISTWATCHES

Splendid unissued navigational watches made to stringent Air Ministry specifications by the World's leading makers: Vertex, Buren, Record, Timor, etc. Breguet hairspring, lever movement (13 ligne) sturdy stainless steel water-resistant case. Fully guaranteed. 7 day appro. Refund guarantee. Will last a lifetime.

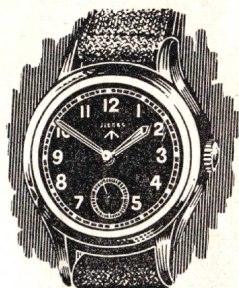

£6. 17. 6  
plus 2/6 post/pkg.  
Other Air Ministry watches (smaller models) available. Used. £4. 17. 6 + 2/6 p/p. Waterproof, Breguet hairspring. Swiss movement. 12 mon. guar.

MB

The LINDERMANN  
'SPOTSCOPE'

20 Power Pocket Monocular



IDEAL FOR BIRDWATCHING  
& GENERAL VIEWING

A super prismatic monocular designed by leading British optical instrument manufacturers to give maximum viewing power with minimum weight. Beautifully finished, first class optical components. Length 6 1/2". Weight 9 oz. Easily carried in the pocket—at a price to suit the pocket!

£5. 17. 6  
plus 2/6 post/pkg.  
Velvet lined leather case £1 extra.

10 or 20 x 50  
PRISMATIC MONOCULAR

Length 6 1/2" Weight 12 oz.

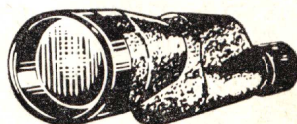

These high quality monoculars are made by a leading British manufacturer. They are wonderfully light and compact, with bloomed optics for maximum light gathering power. Micrometer eyepiece focusing. Available either 10 x 50 or 20 x 50. Giving an excellent 'close-up', they are ideal for birdwatching and general viewing.

£7. 10. 0  
Plus 2/6 post & packing  
Velvet lined leather case £1 extra

UTS

A selection  
of interesting  
CHRISTMAS  
GIFTS

UNITED TECHNICAL SUPPLIES LTD.

BRITAIN'S LEADING SCIENTIFIC CENTRE



# LATEST RELEASE

## OF EIGHT DAY 'Brass' MARINE CLOCKS

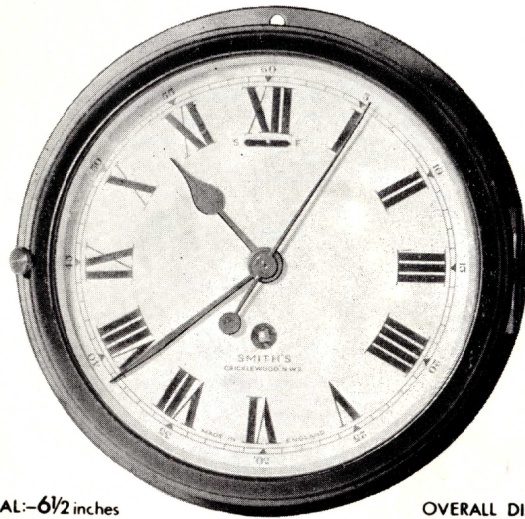

DIAMETER OF DIAL:—6½ inches

OVERALL DIAMETER 8¾ inches

Originally manufactured to Government Specifications for use in briefing rooms, etc. By Smiths of London, these sturdy 8-day clocks are extremely popular for civil uses ranging from ordinary wall clocks to hull clocks on boats, yachts, ships, etc.

Their precision non-magnetic lever movements have hardened steel pinions and hard brass wheels, all highly finished, and are noted for their reliability under all kinds of conditions.

They have white dials with Roman numerals and sweep second hands. They are easy to regulate, being wound and regulated from the front, and are in brass cases with hinged bezels. Painted with black enamel, they are flange mounted from the rear.

**12 Months Guarantee**

PRICE, **£8.15.0**

POSTAGE & PACKING 5/0



MAIL ALL ORDERS TO  
**UNITED TECHNICAL SUPPLIES LTD.**

29 TOTTENHAM COURT ROAD, LONDON, W.1. LAngham 1116-1117-5015

**MB**

### SWISS 1/10th SECOND STOPWATCHES

Manufactured in Switzerland by the World's finest craftsman these excellent watches are noted for their absolute reliability due to their high quality jewelled lever movements, thus we are able to give a 12 months written guarantee with each one.

**UNISSUED  
GOVERNMENT  
SURPLUS**

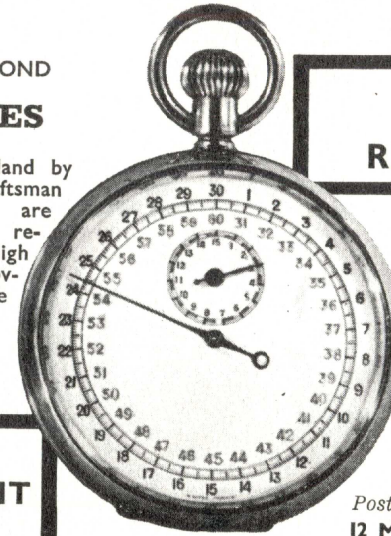

**JUST  
RELEASED**

They have 1/10th second 30 second dials with inset minute recorders and are crown operated. A recent bulk purchase direct from the Government has made it possible for us to offer them at only:-

**£4 - 15 - 0**

Postage and Packing Free  
**12 MONTHS WRITTEN  
GUARANTEE**

## SPECIAL OFFER—FOR LIMITED PERIOD ONLY! OMEGA or INTERNATIONAL

SWISS NAVIGATIONAL WRIST WATCHES MADE TO STRINGENT M.O.S. SPECIFICATIONS



**£12.18.6**

(Today's value—over £50)

Or £3 Deposit and 9  
monthly payments of  
£1.6.6

Due to a recent bulk purchase from the Ministry of Supply, we are able to offer these outstanding watches at this amazingly low price whilst stocks last.

**UTS**



OMEGA Specially designed for the services for split-second accuracy. Swiss high precision 15 jewelled lever movement. (13 ligne) Breguet hair-spring. Sturdy stainless steel water-resistant case. Luminous hands, etc.

INTERNATIONAL Manufactured for the forces with the skill and precision of the finest Swiss craftsmen. 15 jewelled lever movements with compensated balance and Breguet hair-spring. Black dial, luminous hands, etc.

**UNITED TECHNICAL SUPPLIES LTD.**

29, TOTTENHAM COURT ROAD, LONDON, W.1. LAngham 1116 1117 5015