

# BINOCULARS

Riflescopes  
Spotting Scopes

*Insist on*



MB



UNITED BINOCULAR CO.

UNITED BUILDING

9043 SO. WESTERN AVE.  
CHICAGO, ILLINOIS 60620



# United Binocular Company

UNITED BLDG., 9043 S. WESTERN AVE. phone - HILLTOP 5-6166  
CHICAGO, ILLINOIS 60620

RIFLESCOPES  
BINOCULARS  
SPOTTING  
SCOPES

Cable Address: UNIPRODUCT

L. J. THOMAS, Director  
L. J. THOMAS, Jr., Manager

MB

Dear Friend:

Thank you for your most welcome inquiry.

It will be a privilege to help you select the right Binocular, Telescope or Riflescope to satisfy your wants.

Since 1936 UNITED BINOCULAR CO. has specialized in selling binoculars by mail. We carry over 100 different binocular selections (the finest from 3 continents) and offer you a written 30 Day Free Trial Guarantee on every purchase you make from us.

This means, if you are not absolutely satisfied with your purchase, you may return, any time within that Free trial guarantee period, your purchase for either an exchange or a full refund of every penny you paid UNITED. Fair enough?

We know it is, for much of our business comes either from satisfied customers, making additional purchases, or from friends of theirs to whom they recommended UNITED.

If you are buying a binocular for the first time, you will want to read every word of our Unconditional Guarantee reprinted below. It is your protection. UNITED'S tremendous selection, economy pricing and willingness to stand in back of every optical piece sold is why UNITED is known as "America's Leading Binocular Retailer."

Whenever in Chicago it will be a pleasure to have you visit our display sales rooms directly across the way from beautiful Evergreen Park and examine glasses in which you have an interest.

If you need your binocular rushed immediately to you see our Air Mail shipping service (Page 20). When ordering use the enclosed handy order blank and postage paid envelope.

Cordially yours,

L. J. Thomas, Executive Director  
UNITED BINOCULAR COMPANY



L. J. Thomas

## Unconditional Guarantee!

We offer to those ordering direct from United to *TRY* any binocular shown in this catalog for 30 days *AT OUR RISK AND EXPENSE*. If not completely satisfied in every way, return for an immediate, unquestioned refund of every penny you paid us!



# When Choosing a BINOCULAR

MB

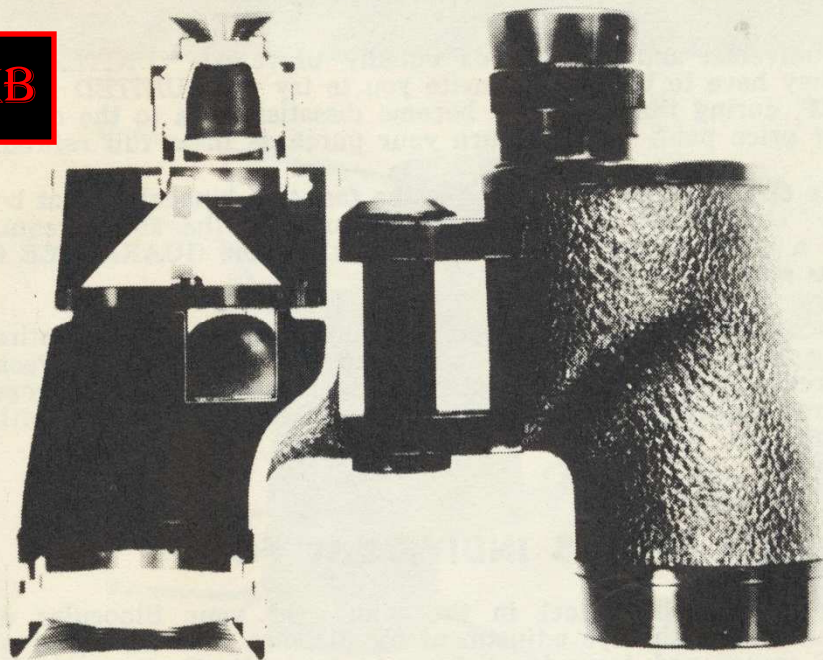

Cross section of our Precision Binoculars showing how prisms are set on metal shelf and firmly held into position with metal bands.

is that objects viewed will appear seven times larger than when just viewed by the naked eye. Therefore, the larger the first number the greater the magnification. The SECOND number, the "35", is the measurement in millimeters of the diameter (width) of the front (large) objective lens. Example: Since "25" mm are equal to approximately one inch the figure "35" would indicate the front objective lens would measure approximately 1½ inches across. The larger the number, at a given power, the more light gathering capacity and the greater the brilliance and sharpness of detail of the object you are viewing. All UNITED specifications of power and light transmission are twice triple checked for absolute accuracy.

## FIELD OF VIEW

is what you see through your Binocular from right to left or left to right at a given distance. All UNITED "field of view" specifications are given at the recognized standard of 1000 yards. Therefore, our listing of "field of 375 feet" means that at 1000 yards the width of your vision is what you would be able to see at 375 feet.

(Continued on next page)



## Compliments United On Fair Business Methods

" . . . I would like to compliment you on your fair and sincere method of doing business. It has been many years since I had the pleasure of doing business with an organization such as yours who are obviously interested in your customers problems and are willing to make every effort to please them.

Please be assured that as the CAPTAIN of the VANDENBERG AFB PISTOL TEAM, a member of the N. R. A. and the Lompoc Sportsman Association, I shall make every effort to recommend your company to all my associates.

Again, my thanks . . . "

Mr. Jean N. Arnold,  
Lompoc, California



# BUY UNITED AND SAVE

## BE SURE THAT

The Binocular you buy is sold by a reputable firm—a firm that stands fairly and squarely in back of the binocular you purchase. A firm with a reputation of binocular "Know How," Dependability and Fair Dealing. UNITED has served over 1,100,000 folks and established the UNITED 30 DAY MONEY BACK GUARANTEE offer in 1936!

## WHAT 7 x 35 MEANS

The FIRST number, the "7", designates the power of your Binocular. It means your binocular will bring objects you are viewing 7 times closer to you. Or, another way of saying it



**MB**

## UNITED BINOCULARS COME FROM 3 CONTINENTS

UNITED customers are universal and their needs equally universal. UNITED'S requirements are stringent. They have to be, for we invite you to try your UNITED binocular purchases for 30 days. IF, during that time you become dissatisfied as to the quality, workmanship, performance or price paid, simply return your purchase for a full refund.

Our suppliers in all parts of the world are alerted to the fact that binoculars that bear the UNITED "Seal of Quality" etched into their frames have to meet the above requirements. Regardless, of where a UNITED binocular comes from the same GUARANTEE OF SATISFACTION applies. **You must be satisfied.**

Time after time UNITED has pioneered in introducing to the buying public an entirely new optical innovation at a popular price. UNITED pioneered in introducing Pocket Binoculars; Two-in-One (interchangeable lense) binoculars; Midget Telescopes; Microscopes; "Whisper Weight" high powered binoculars; economy priced Riflescopes and Spotting Scopes; Ultra Wide Field Binoculars; etc., etc.

## CENTER FOCUS VERSUS INDIVIDUAL FOCUS

CENTER FOCUS means there is a focusing wheel in the middle of your Binocular eye bridge which allows you to manipulate the eye adjustment for distance with the tip of one finger. INDIVIDUAL FOCUS means you focus for distance by first adjusting one eyepiece and then the other. The discussion as to which system is more efficient will rage on for generations. Both have their fine points, with our opinion being that it is a matter of PERSONAL PREFERENCE as to which will give YOU the best results.

## 30 DAY MONEY BACK GUARANTEE

UNITED'S Brand New binoculars are "bargain priced." Compare their quality of workmanship, materials and performance with other firms' binoculars and prove UNITED'S Money saving prices for yourself. Since 1936 UNITED has sold binoculars on an unconditional money back guarantee. Buy-Try any United product for 30 days (one full month) and if not completely satisfied, return for an immediate unquestioned refund. UNITED wants above all things, your good will and confidence. It has been Quality Merchandise Priced Right plus Fair Treatment that has made UNITED "AMERICA'S OUTSTANDING BINOCULAR RETAILER."

## WHICH BINOCULAR SHOULD YOU BUY?

Your choice first should be a glass made by a quality manufacturer, sold by a reputable dealer. Decide for which purpose you will mainly use your pair. UNITED'S pricing policy makes it possible for you to enjoy several pair for your every need.

**POCKET BINOCULARS** For when size is an important factor. UNITED OFFER **6X, 7X** and **10X**, precision made glasses you can slide in and out of your pocket on a few seconds notice. Compact, powerful glasses.

**6X30 and 8X30 BINOCULARS** Considered by many the "Universal" size glass for they are lightweight and small, easy to use.

**7X35, 7X40 and 8X40** glasses give you the combination of MORE Power and a LARGER front lense for increased viewing pleasure. The "All Purpose" Models.

**7x50, 10x50, 12x50, 15x65, 16x50, 20x56, and 20x60** conquer distance. Here HIGH power teams up with LARGE sharp, front lense that "reach out" and bring far-away objects right up to you. UNITED streamlined construction methods and new, lighter stronger all metal frames make them **EASY TO HOLD** and **EASY TO USE**.



# ARE NOT BUYING JUST ANOTHER BINOCULAR WHEN BUYING A UNITED BINOCULAR YOU

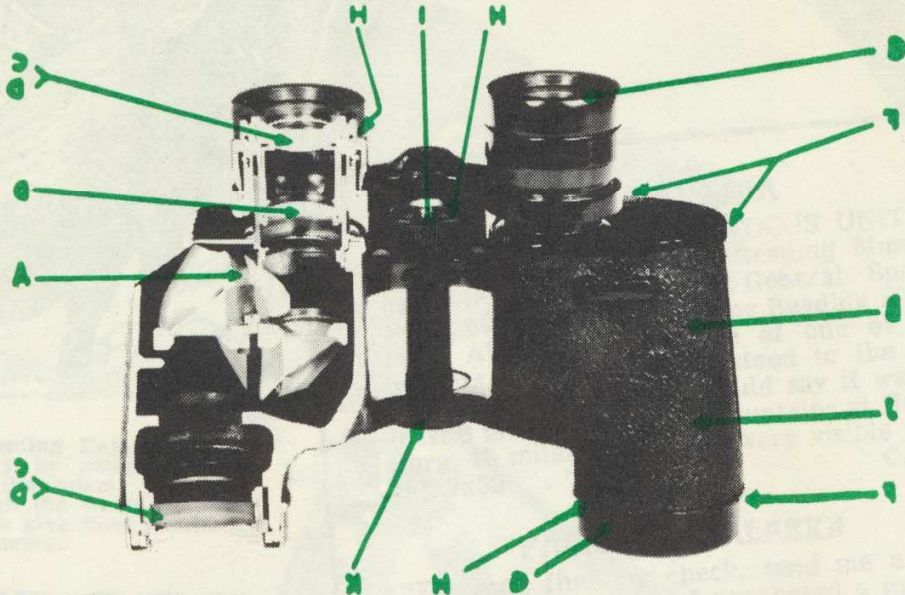

See for yourself the quality construction of all UNITED Binoculars

**D** All lenses in UNITED Binoculars are precision ground by skilled optical craftsmen and all edges, surfaces and depth of lenses are painstakingly ground to rigid UNITED standards. Assuring you of SEEING MORE—BETTER.

**E** UNITED cases are of good quality. Durable and scuff resistant. With safety snap fastener. With sturdy, shoulder length carrying strap. Lined with velvet soft plush cloth for rich luxurious appearance and added protection for your UNITED Binocular.

**F** UNITED standard models are made both wa- SEAL to aid in keeping out undesirable water and dust.

**G** UNITED now happily offers a rich looking gloss finish that will not finger smudge as do single enamel shiny applications. These extra enamel applications give you lasting beauty.

**H** All barrels and moving parts are DEEP and LONG threaded for additional strength designed to give you better construction and better performance at all times.

**I** All moving parts, focusing mechanisms, etc., are triple tested for smooth trouble free ac- tion. Moving parts not TOO loose or TOO tight, but JUST RIGHT for easy finger tip adjust- ments.

**J** UNITED Binoculars come in all popular "Ger- man" as well as "Streamlined" design for your personal preference. Both are popular and are palm fitting (fits your hand like a glove) mak- ing UNITED Binoculars a truly great pleasure to use.

**K** All hinged parts are strong and durable—firm to your touch, still smooth and elastic to meet your needs, quickly.

These and many other features are incorporated into UNITED Binoculars to give you a lifetime of pleasure and service even with rigorous use.

**A** Prisms are set on metal shelves and firmly clamped into position with tension spring metal bands—not just cemented into position. Users get more durability, avoid a common breakage problem one experiences when using cheaply made binoculars.

**B** Revolutionarily "Whisper Weight" metals and alloys are used to give you sturdy compact bodies that with reasonable care should give you a lifetime of satisfactory service. Notice carefully the streamlined design to give you that wanted "Whisper Weight."

**C** Achromatic lenses are used in UNITED binoc- ulars. In layman's language this means that lenses are cemented together with "Canadian Balsam" to give you color free vision. It eliminates distortion at the edge of your view and gives clear, crisp depth of image.

**BOUGHT UNITED 20 YEARS AGO . . . BUYS AGAIN**

"Enclosed find check for \$204.00. During the past 3 to 4 years I have bought 3 different makes of binoculars but none ever were as good as one just received from you . . ."

Mr. Ted Thomas, Johnson City, Tenn.



## BUY UNITED AND BE SURE!



# BINOCULARS *for Every Purpose.*

## *for* HUNTING



Increase your Hunting Enjoyment and Hunting Efficiency by owning several pairs of UNITED Binoculars. Each year we carefully weigh the wants of hunters, in an effort to give them maximum Binocular Performance.

## *for* OUTDOOR ACTION



Have MORE fun by seeing MORE. Enjoy greater fun at rodeos, sailing regattas, football games, all sporting events, etc. See minute details like facial expressions, body contacts, etc.

## *for* NATURE STUDY



Watch distant animals as they scamper over hills, mountains and country side. Detect small animals in heavy brush. Watch colorful birds. Actually "travel miles" while sitting still by using UNITED binoculars!

### PENNSYLVANIA

"With my 7x50 CENTER FOCUS UNITED Binoculars I can see the Reading Municipal Airport, now called General Spaatz Field, even reading the name Reading Municipal Airport on the side of one of the hangars. From where I stood to the airport in a direct line, I would say it was at least 3 miles. The Blue Mountains at Hamsburg, 18 miles away, were very visible with the 7x50. . ."

C.H.P.

### FAIRBANKS, ALASKA

"Enclosed find my check, send me a pair of 16x50 binoculars. I purchased a pair of 6x30 glasses from you two years ago and have been more than satisfied with them. We have used them during the winter and the hunting seasons and have bagged our moose both years. If the 16x50 are as good as the 6x30, I will be more than satisfied."

A.K.H.

### VIRGINIA

"I just returned from a "Chuck" hunt and I wish to tell you that your 7x35 binoculars are really wonderful. I have compared them with glasses costing much more and find them to be a real value."

C.R.P.

### GREEN RIVER, WYOMING

"During the last elk hunting season here in Wyoming, I used one of your 7x50 Binoculars (a friend's) and I was well pleased with it. I am enclosing my check for the 7x50 Binoculars . . ."

C.E.T.

### CONNECTICUT

"Received the 16x50 Binoculars . . . I am extremely pleased and satisfied with them for they are much more than I expected . . . I have never been dissatisfied with any pair of binoculars that I have purchased from you. This pair is no exception. They are as sharp and clear as any I have ever used. I can actually, under favorable conditions, spot .30 calibre bullet holes at 200 yards . . . I hope to be able to sell more of my friends on buying glasses from you. They certainly couldn't possibly do any better, if as well, anywhere else."

A.A.M.



Buy **UNITED** and be *Sure!*

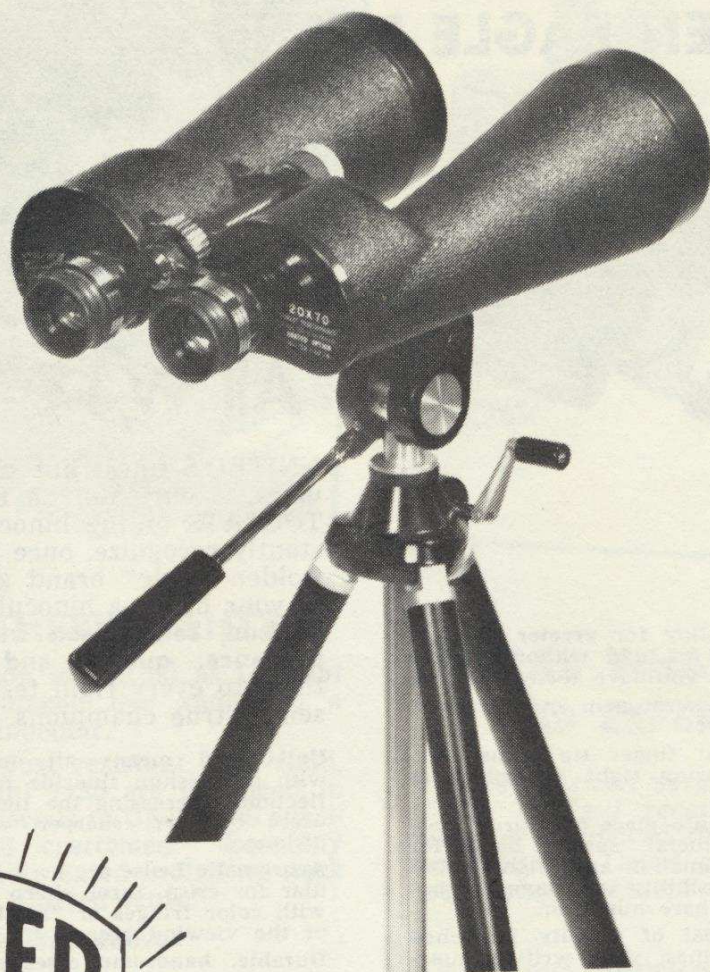

**MB**

**UNITED**

SEAL OF QUALITY

**Plush Lined Case**



**20X70**

**GREAT Power ..... GREAT Clarity**

For spectacular close up viewing of distant images! Ultra high 20 power magnification. 70 mm front lenses are big 3 inches across to give more light which results in sharper, clearer images. Streamlined, one piece body design—latest, modern styling. Fast, easy center focus. Rubber eyecups for comfortable, full field viewing with or without eyeglasses. Use **WITH** or **WITHOUT TRIPOD**, but comes with adjustable tripod which extends from 22 to 60 inches in height. With micrometer controls. Field 183 ft. 1000 yards. Weight 58 oz. Binocular is 10½ inches high. Carrying case and straps for Binocular. Superb optical and mechanical quality!

**\$375**



WHERE PRICE AND QUALITY ARE "UNITED"



# UNITED'S LUXURY BINOCULARS

## THE GOLDEN EAGLE BRAND

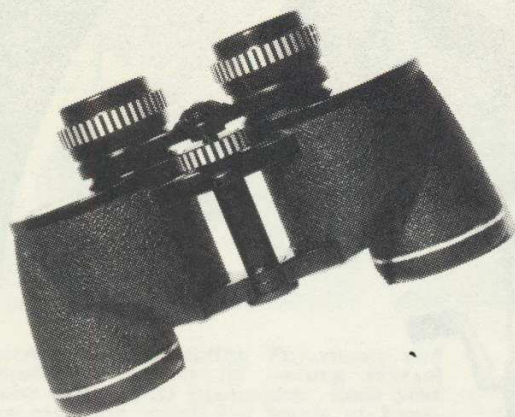

**MB**

### All W-I-D-E Angle

Lightweight aluminum alloy for greater strength and durability yet, easy to hold without fatigue and with an ease of focus you have always wanted. Streamlined for an even surer grip and a neater, natter, appearance.

Center Focus for instant finger tip adjustment. Provides individual focusing right eye piece as well.

Prisms precision locked into place on sturdy metal shelves with durable metal "spring" bands for lasting, trouble free, collimation and alignment of optics. It cuts the possibility of damage, because of droppage, to a bare minimum.

United Golden Eagle Seal of Quality is etched into their handsome frames, your written guarantee of satisfaction, because they are made to rigid UNITED REQUIREMENTS by skilled optical craftsmen in Japan.

UNITED'S finest line of brand-name binoculars, is our "Golden Eagle" series. ARISTOCRATS of the binocular world. You instantly recognize, once you see a "UNITED Golden Eagle" brand glass, that you have in your hands a binocular that invites comparison, comparison with others as to appearance, quality and performance. Put them to every rigid test, they are in every sense "true champions."

Uni-Coated means all optical glass is coated with magnesium fluoride to lessen disturbing reflections, increasing the light transmission, giving users brighter, sharper, crystal images at all distances.

Achromatic Lenses are used in each UNITED binocular for crisp, razor sharp viewing. It does away with color fringes or "rainbow" hues at the edge of the viewing area.

Durable, handsome cases give UNITED "Golden Eagle" binoculars ample protection. Plush lined cases have "Sure Lock" fasteners for safety in carrying.

Model	Field of View	Relative Brightness	Height in Inches	Retail Price
7x35	657 Ft.	25	4 $\frac{3}{4}$	\$129.50
7x35	578 Ft.	25	5	99.50
8x40	499 Ft.	25	5 $\frac{1}{2}$	112.50
7x50	525 Ft.	50.4	6 $\frac{3}{4}$	119.50
10x50	369 Ft.	25	7	129.50
20x60	180 Ft.	9	9	175.00

**7x35** Use for all purpose. **SUPER WIDE ANGLE** of 657 feet at 1000 yards! **\$129.50**

**7x35** Another **WIDE ANGLE** glass for vacationing, races, bird watching, boating, etc. **\$99.50**

**7x50** **WIDE ANGLE** "Day and Night" Glass 50 mm front lense gives it tremendous light gathering power. **UNITED** sells more 7x50 Binoculars Than Any Other Model **\$119.50**

**8x40** When extra Power and **WIDE ANGLE** are wanted and you wish crisp brightness **\$112.50**

**10x50** (Wide Angle). A Powerful, Wide, angle binocular which gives you **TEN POWER** and also gives you fine light transmission **\$129.50**

**20x60** (Wide Angle). Tremendous Power with 60 mm front lense for more light. **Wide Angle**. For those who want the absolute tops in Power Performance! **\$175.00**



# A LIFETIME OF PLEASURE





### 7 x 35 FEATHERWEIGHTS

The above illustration is factual as to what you see with the naked eye and thru a UNITED 7 X 35 binocular.

**FEATURES!** Water-dust resistant. 375' field. 20 ounces! 5½" high! 7x35 are produced in Japan of quality materials to UNITED'S specifications by skilled craftsmen. Economy priced and handsomely cased including neck and shoulder straps. Coated lense!

As described above

7 x 35            Center focus            \$59.50



### 7 X 35 "ARISTOCRAT"

Good quality. Good performance. Economy Line. 5½" high. Weighs 20 oz. With sturdy case, straps.

Center Focus            \$49.95

### READ WHAT DEALERS AND EXPERTS WRITE

*"I have received very favorable comments of the 7x35's I received from you. One customer compared them with a pair costing \$150.00. Could see no difference between glasses except the price."*

J. A. N., MINN.

*"One of our customers had the 7x35 out on a bird study tour the other day and compared them with binocular of three times the list price and told us they compared favorably."*

M. E. P., PENN.

*"From what experience I have had with them I know they are of excellent quality both optically and mechanically."*

Warren Page, Shooting Editor

*"I have been using a pair of your 7x35 Center Focus and coated optics for over a year. They are excellent. Please write Mrs. H. C. Jr. about them."*

Connecticut WILD LIFE SANCTUARY

*"Several years ago I purchased a 7x35 Binocular from you which was the best investment I have ever made in the binocular line. In fact, it is the best binocular I have ever used regardless of price."*

F. J S., West Virginia





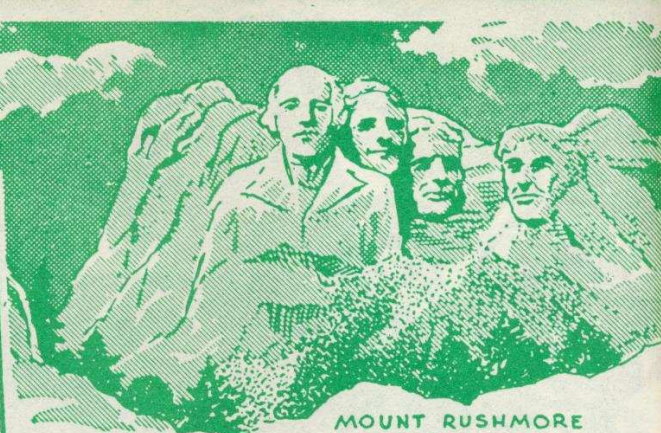

MOUNT RUSHMORE NATIONAL MEMORIAL



## 7x50 "DAY and NITE GLASS"

It's tremendous light gathering power makes the 7x50 binocular a favorite of Armed Forces the world over. Unusually large objective lens (50MM-2" across!) gives tremendous light gathering power. Viewing is good even in the faint light of early morn or at dusk. Center Focus with individual focus right eye piece. Angular field is 7.1 degrees. Exit pupil 7 MM.

### COATED LENS

Skilled optical craftsmen have combined precision optics with durable, all-metal, lightweight frames. Made in Japan. Weighs only 35 ounces! 6 3/4" x 7 1/4". Field at 1000 yards is 375 feet. With usual sturdy carrying case and straps

**\$65.00**

## 7x50 OWNERS ARE ENTHUSIASTIC

### GAME WARDEN

*"I have used my 7x50 Day and Night glasses constantly since purchasing them some three and one half years ago... I have tried many makes and types of binoculars but this glass is best suited for my work."*

H. M. G., COLORADO

### GUIDES

*"Your 7x50 Center Focus are everything your catalog claims and more. Use them in the boat every day and some of the other guides have asked me to get some for them."*

J. S. A., MINN.

### TEN YEARS

*"During the past ten years I have ordered several 7x50 binoculars from you without any dissatisfaction on the part of anyone to whom I have given them."*

C. S. C., MICH.

### DEALER NEEDS MORE

*"Ship 2 more pair 7x50 Center Focus. Received mine this morning and so pleased I sold these two pair and probably another . . . in about 15 minutes!"*

R. F., FLORIDA

## United Binoculars Meet Expectations



*"Received the 7x35 Wide Angle binoculars, 20X Spotting Scope and Telescope. All measure up to high expectations . . . Enclosing \$40.00 for Riflescopes . . ."*

Mr. Glen J. Wright,  
Ogden, Utah



**AMERICA'S WIDEST SELECTION**



# 8x30

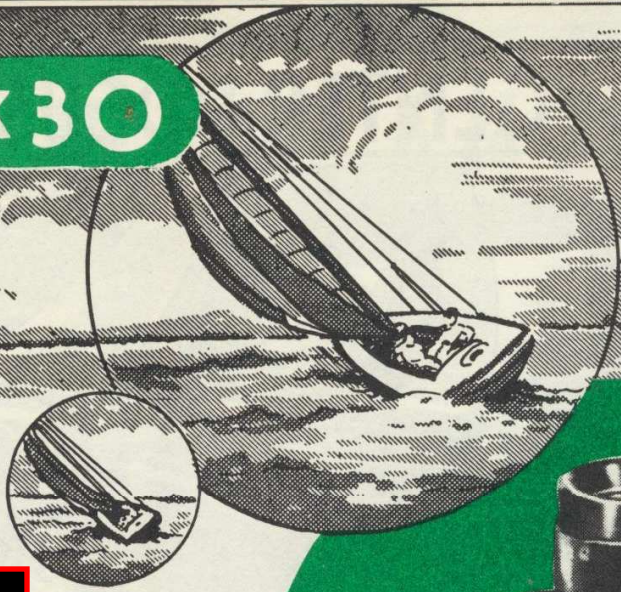

**MB**

**See  
MORE  
BY USING  
INCREASED  
POWER**

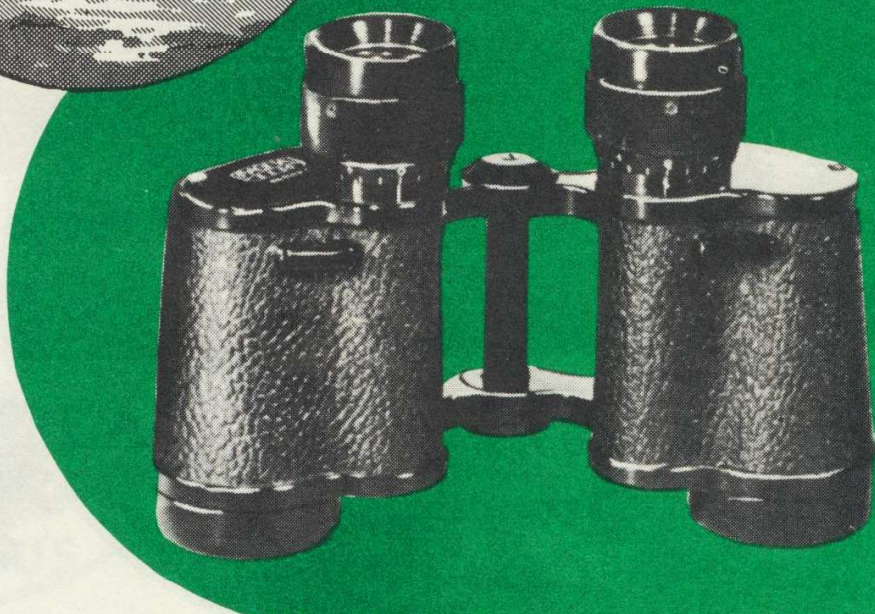

True zephyr weights, weighing only 16 to 18 ounces each! Water-Dust Resistant. Accurate, long range viewing binoculars. This true 8-power champion gives you a 7.5 degree field of vision with a field of view of 390 feet at 1000 yards. Exit pupil 3.6 mm. Each glass on this page has the same compact (4½ x 5¼") frame! Real, concentrated power! COATED LENSE to assure your getting brighter, more detailed images at all distances. Come with Fine Carrying Case and Straps as do ALL UNITED Binoculars.

## 8 X 30 LIGHTWEIGHT CHAMPION

UNITED is proud to offer these super-fine individual focusing binoculars especially suited for distance viewing of far off objects. For with these binoculars you secure exceptionally brilliant illumination and razor sharp detail of objects, even miles away. Made in Japan, these precision constructed UNITED binoculars are produced of quality materials by skilled craftsmen and are Unconditionally Guaranteed and Economy Priced. In addition, they have many, many construction features found generally only in higher priced binoculars. With plush lined carrying case, neck and case straps \_\_\_\_\_ **\$39.50**

### 8X30 CENTER FOCUS

With Individual Focusing Right Eye Piece. A Big Value **\$45.00**

### 10X30 INDIVIDUAL FOCUS

6.5 Degree or 340 Foot Field. Economy Buy **\$45.00**

### READ THESE EXTRACTS FROM USER'S LETTERS

"8x30 UNITED Binocular is ideal for Sports viewing. Lightweight etc."  
**Sport Magazine**  
"About 2 years ago I bought a 8x30 binocular, am well pleased and have recommended you to friends. Please send me etc."  
**C.E.S., Kansas**

"Clearest glasses I have ever seen. What pleases me most is the complete absence of white haze."  
**W.M.C., California**  
"The pair I received on the 29th are terrific. Had to give them to my buddy so ship this order (fast) as I need them for chucks."  
**T.M., New Jersey**

"About the nicest and handiest I ever tried. I will recommend them to anyone wanting an all around handy set of glasses."  
**J.P.S., Michigan**  
"8x30 are a good pair of binoculars. I notice your prices are lower than some places here in town."  
**T.H.D., Ohio**



# THIS SEAL PROTECTS YOU!



# INDIVIDUAL *and* CENTER FOCUSING

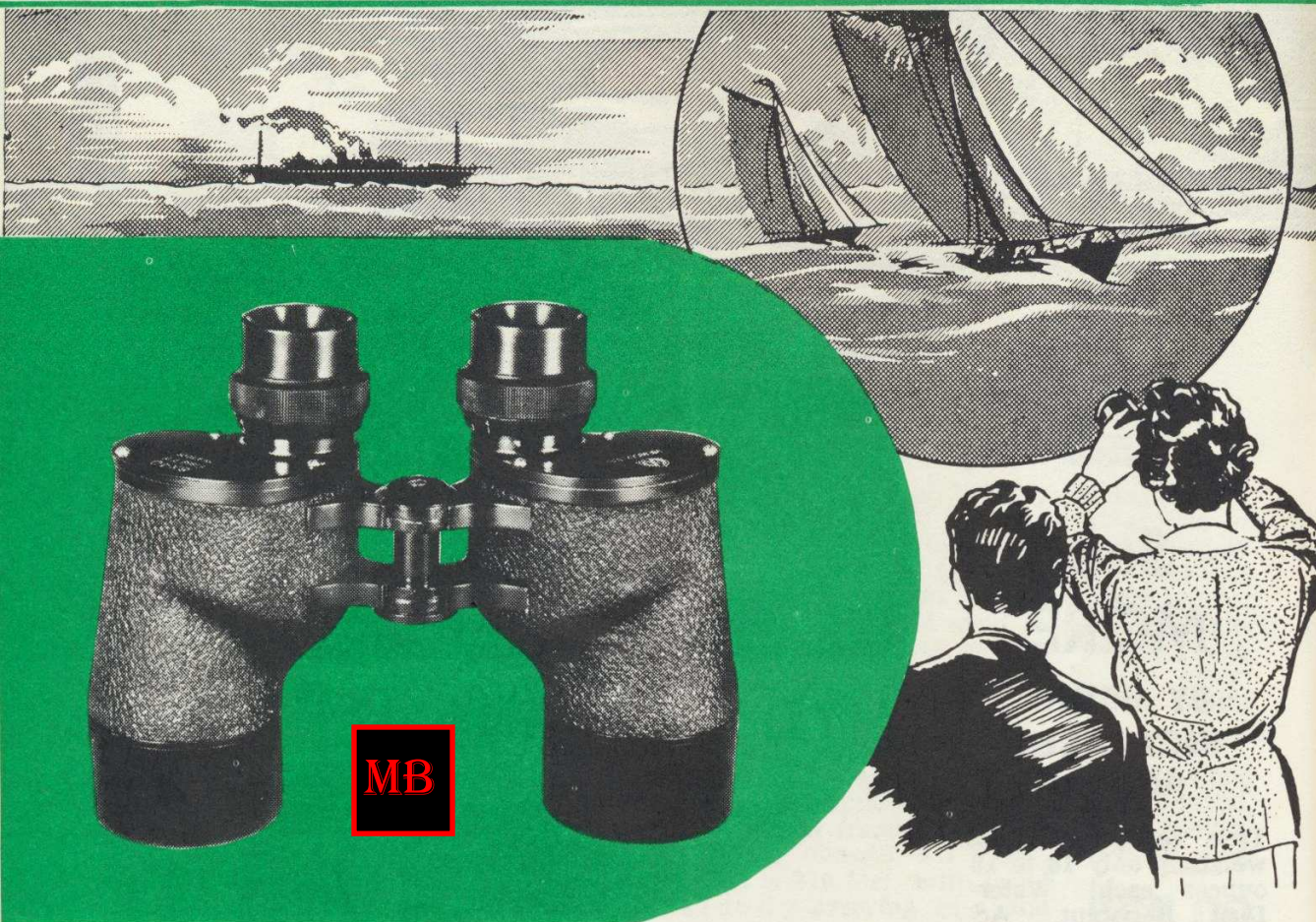

**MB**

## A USER WRITES

*"Tested your 8x40 coated with other makes and find them a real treasure for all around use. For the price they can't be beat."*

**K.V.B., Ohio**

*"We received the two pair of glasses ordered from you recently and are well satisfied with them. Enclosing check for \$154.80 for which please send, etc."*

**W.P.B., Utah**

*"I received my 8x40 glasses. I am very pleased with them. Even with the haze in mountains the glasses are very clear. I showed them to several of my friends and you will probably be receiving orders from them."*

**K.H.R., Philadelphia, Pa.**

## 8x40

We present here, in our opinion, a new high accuracy in binoculars. It is easy to give UNITED'S Unconditional Guarantee of Satisfaction on these handsome, sturdy, streamlined 8x40 binoculars. We know from hundreds of letters and conversations with satisfied users that you, too, will be thrilled once you handle and use these superb binoculars. UNITED VALUE! COATED LENSE to assure you brighter, sharper, clearer images. Made in Japan, these precision constructed UNITED Binoculars are produced of quality materials by skilled craftsmen and are Unconditionally Guaranteed and Economy Priced. Fine case and straps. Measures 5½"x6¾". Very Fine Field of View. Lightweight. Exit Pupil — 5mm. Water, Dust Resistant. Carry UNITED "Seal of Quality."

## 8x40

Center Focus with individual focussing right eye piece

**\$69.50**

## Pleased With United 15x65 & 22x80



*"Received the 22x80 Binoculars (Retail \$275.00). They exceed my expectations. I use the 22x80 to "call size of horns" on a deer. Last season I located 11 Buck Deer and three were killed at 350, 480 and 1050 yards. This photo is from a western hunt where I used your 15x65. Mr. Glen A. Arnold, McClure, Pa."*



**WHERE PRICE AND QUALITY ARE "UNITED"**



this  
7X35

# WIDE ANGLE

# IS *Lightest Weight*

**MB**

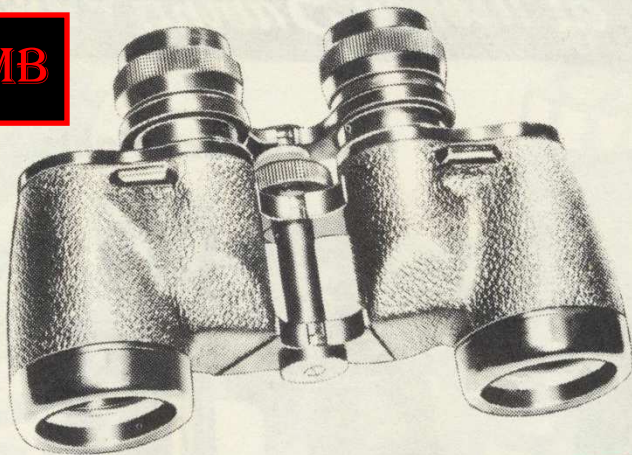

- FEATHERWEIGHT
- ONLY 24<sup>3</sup>/<sub>4</sub> OZ.!
- STURDIER
- 5 x 7<sup>1</sup>/<sub>4</sub> inches
- Lense Hard Coated

## 7 x 35 CENTER FOCUS

### 578 FOOT FIELD!

Each year **WIDE ANGLE** binoculars become more popular because **oversize prisms** permit you to see **MORE** from left to right—No need to move the binocular **ONLY MOVE YOUR EYES . . .** much like a **WIDE ANGLE** screen at the movies.

United's 7x35 Wide Angle gives you a **tremendous** field of view of 578 feet at 1000 yards (the field of view of the average binocular is about 375 feet).

Durable aluminum alloy is used to give strength and light weight. Streamlined one piece body. **CENTER FOCUS** with individual focusing right eye. 7 Power with 35mm (almost 1<sup>1</sup>/<sub>2</sub>" across) front lense. With rich case and **\$79.50** straps.



**7x35  
525 Foot Field**

Popularity of Wide Angle's are on the increase because you see **MORE** from left to right like a Wide Angle Screen at the movies. Lightweight — 28<sup>3</sup>/<sub>4</sub> oz. **CENTER FOCUS**. 5<sup>1</sup>/<sub>8</sub> inches high. Coated lense. Streamlined one piece frame. Fine Case, straps included.

**Popular Priced . . . . \$59.50**

**Best Ever Seen . . . .**  
*"Received your 7x25 and 7x35 Wide Angle binoculars. They are the very best I have ever had or seen . . . I have a friend who is a recognized authority on optical instruments. He said they were far superior to any glass he had examined. He was especially impressed with the performance of the 7x35, 578 ft., field model.*  
 G.W.F., North Carolina



# SELLING NATIONALLY SINCE 1936





# Your **GUARANTEE** of FINE OPTICAL QUALITY at Money Saving PRICES



10x50 Center Focus.....	\$49.95
12x50 Center Focus.....	\$54.95
16x50 Individual Focus .....	\$57.95
16x50 Center Focus.....	\$59.95
20x50 Center Focus.....	\$69.95

## 29 oz. Featherweights



In years past, when a sportsman wanted a high powered binocular, he had to put up with a heavy, clumsy binocular. High powered glasses were made with heavy metal frames for durability. They weighed as much as 5 pounds each. Good glasses, but extremely difficult to hold steady for any appreciable length of time. In addition, their frames were normally "Squared" and therefore, it was hard to keep objects in focus for they balanced poorly in a user's hands.

However, **NOW** with today's lightweight-yet-sturdy metals and with modern streamlined methods of construction **UNITED** is pleased to offer high powered "WHISPER WEIGHT" binoculars that are truly **EASY TO HOLD** and **EASY TO USE**.

Our 10 X 50 is 6¼ inches high with a field of 262 feet at 1000 yards. 12 X 50 - 7" high — 262 foot field. 16 X 50 - 7" high — 190 foot field, 20 X 50 - 7" high — 131 foot field. Each weighs only 29 ounces.

### FINE VALUES — ECONOMY PRICED

To assure you of securing bright, sharp, clear images in these high powered, zepher weight binoculars, lenses are coated with magnesium fluoride. In addition, they are of course Achromatic, with color corrected lenses and are made water, dust resistant. Made in Japan, these precision constructed UNITED Binoculars are produced of quality materials by skilled craftsmen and are unconditionally Guaranteed. These five binoculars come with handsome cases and straps.

## New! Electric Z-O-O-M

New and exciting **ELECTRIC ZOOM** action! Zoom automatically from 12 power all the way to 40 power with just a touch of the button. Big 40mm front lens (about 1½" across). Coated precision optics provide sharp, bright



12X  
to  
40X

viewing for spotting targets, general viewing, scanning countryside, for vacations, trips, etc. Handsomely styled in charcoal gray metal construction with sparkling chrome trim. Complete with sturdy adjustable 17" tripod and precise micrometer focussing arm. Powered by 2 standard penlite batteries (not included).

**\$54.50**



# YOU MUST BE SATISFIED



# ELECTRIC POWER ZOOM<sup>®</sup>

MB

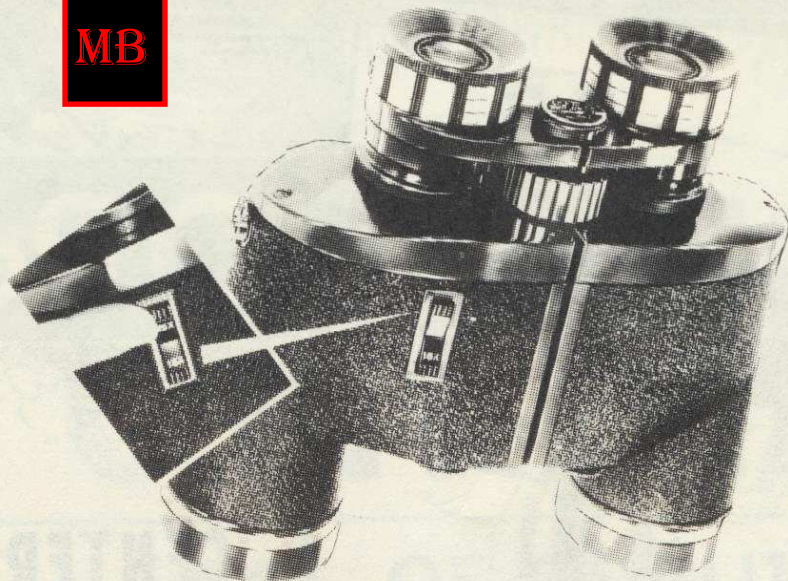

## NOW! — 7 to 15 Power WIDE ANGLE Electric Power Z-O-O-M

7x TO 15x ELECTRIC POWER ZOOM. Fabulously new! Like no other binocular ever made. Looks different because it is different. Now! An automatic push-button zoom binocular. Watching the quarterback or pitcher? Zoom in on his throw by touching a button! Spotting a deer or a distant view—Zoom in or out like a TV camera.

**UNCONDITIONALLY GUARANTEED  
FOR 2 YEARS**

Each instrument passes 23 rugged inspection tests and is unconditionally guaranteed for 2 years.

Fantastic ease of operation. Complete with protective carrying case of genuine leather

trimmed with chrome. Zooms from 7 power to 15 power at the touch of a button. Object remains in sharp focus through the zooming range. WIDE ANGLE field of view of 367 ft. at 7x. Big 40mm objective lenses are UVC coated to deliver a brightness rating of 57. Adjustable eye cups for full field viewing WITH OR WITHOUT glasses. Deepset front lenses furnish protection to optical surfaces. Fully coated with magnesium fluoride for maximum clarity. Center focusing. Built in tripod adaptor. Powered by two penlight batteries (not included) Ht. 7". Wt. **\$250.00**  
39 oz.



## 7X-12X ZOOM FAST — Lever Power Focus

**NEW!** 6 binoculars in 1. Change from 7 power to 8, 9, 10, 11, or 12 power **WITHOUT** removing binoculars from your eyes. 7" high. Wide 40 mm front lens (1½" across!). Center focus. Achromatic. **COATED LENSE.** Luxurious "Diamond Cut" chrome trim. Sturdy plush lined case, straps included. **\$99.50**



**UNITED - BINOCULAR CENTER OF AMERICA**





# 10 Power..



## CENTER FOCUS

Our 10 Power, Center Focus binocular weighs only **6½ ozs**; measures **3"x3⅛"** yet its performance will amaze you. Especially desirable when power without bulk is wanted.

Precision engineered for lasting satisfaction. All metal construction with threaded fittings thru-out. Color corrected. Achromatic binoculars that give you instant finger tip adjustment.

Rich deep satin black with lustrous chrome trim. Treat yourself and your friends to quality and real viewing pleasure at an economy price. Lense Hard Coated!

See objects crystal-clear at all distances. This is the highest power, vest-pocket binocular UNITED is willing to grant UNITED'S famous "Seal of Quality." Made in Japan.

With Genuine Leather Case and neck straps

**7  
POWER**

Fits in palm of your hand... tuck in your pocket, out of the way, yet ready for instant use. Achromatic prism binocular gives excellent field of 326 ft. 1000 yds. **7 POWER!** Quality construction. Rich all chrome finish. Center focus with individual focusing right eye piece. Weighs only **5½ozs.**, coated lense! Complete with handsome leather case, neck straps. **List \$39.95**

**10x Pocket**

Center Focus With Individual Focusing Right Eye Piece.

**List \$49.95**





WHEN YOU THINK OF  
BINOCULARS.. *Think of*

**UNITED**

**SEAL OF QUALITY**



## **BINOCULAR CENTER OF AMERICA**

Your Binocular Dollars are important, don't risk them on untested brands. Get ALL you can for your money — BUY UNITED Binoculars.

UNITED has used an absolute 30 DAY MONEY BACK OFFER for every binocular they sell and has made that offer since 1936! UNITED'S "Best-By-Test" binoculars, to supply your every want, come from 3 continents. UNITED'S large stocks and central location assures you quicker delivery no matter where you live.

UNITED Binoculars must first pass rigid field tests before acceptance. Every possible factor is weighed . . . Quality of Construction . . . Field of View . . . Weight . . . Precision Grinding of Lenses . . . The way a Binocular Handles and Balances in the hand, etc.

Meeting rigid field tests, the binoculars are then sent to Binocular Experts for their candid opinions. Assuming both tests are satisfactory the specifications are then sent to leading binocular manufacturers to discover if the accepted binocular can be mass produced to retail at popular prices.

Assuming they have met every rigid UNITED requirement the UNITED "Seal of Quality" is etched into their frames, assuring buyers that if not satisfied in every possible way they can return them after a liberal 30 day Free Trial Period for an immediate unquestioned refund of every cent paid for their binocular purchase. That is why we say — **When You Buy Binoculars — Protect Your Investment — Buy UNITED.**



**QUALITY SELECTION FROM THREE CONTINENTS** 17



# UNITED'S *New* 20 POWER SPOTTING SCOPE

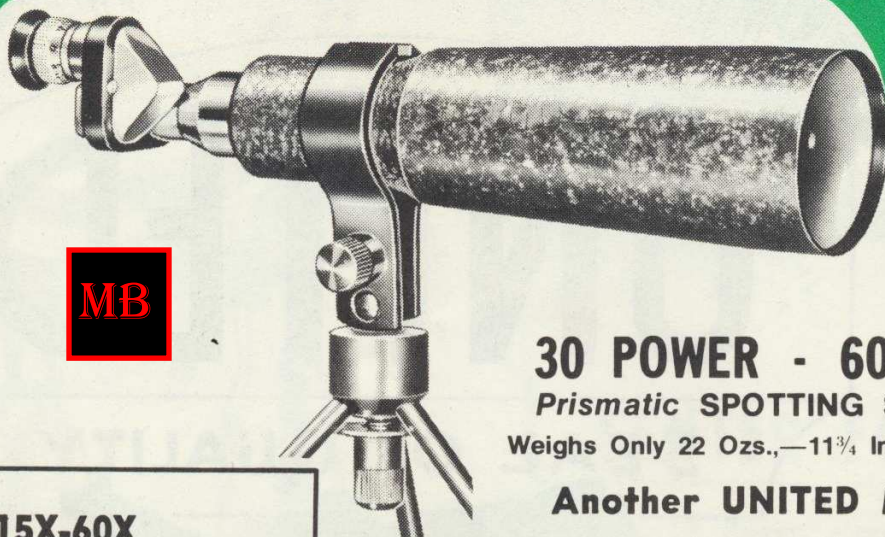

**MB**

## 30 POWER - 60 MM Prismatic SPOTTING SCOPE

Weights Only 22 Ozs.,—11 $\frac{3}{4}$  Inches Long

### Another UNITED First

A compactly made, precision machined Prismatic Spotting Scope. Quality construction throughout. Threaded metal fittings. The Scope itself weighs only 22 ounces. Is only 11 $\frac{3}{4}$  inches in length. The price of \$69.50 **complete with tripod**, makes it an outstanding buy for those who want top results at a reasonable cost.

Has a luxurious black crackle finish, handsomely trimmed with chrome. Comes with safety dust cap which screws into position over large front lense when not in use.

### 107 $\frac{1}{2}$ FOOT FIELD AT 1000 YARDS

Not a mere telescope, but instead, just like an expensive Binocular, PRISMS ARE USED to eliminate distortion, give a greater field of view and assure the user sharp, detailed definition at all distances. The Vital surfaces of all lense and prisms have been 100% COATED for brighter, clearer images.

The Uni-Tripod is manufactured of sturdy, durable, "whisper weight" Duralumin giving you a minimum of bulk and weight. Tripod is engineered with swivel head so you can sight up, down, across or at any angle you choose. Made in Japan to rigid UNITED REQUIREMENTS by skilled optical craftsmen which explains why the quality is so high and the price so reasonable.

Both Scope and Tripod  
Only ..... **\$69.50**

Handsome Leather Carrying Case and Straps,  
Accommodates Scope and Tripod, included!



## 15X-60X Spotting Scope



**CHANGE POWER in seconds** — comes with 5 individual eyepieces (15, 20, 30, 40 and 60 power). Uses **BIG** 60mm (2 $\frac{1}{2}$ " across) front lense to give you **MORE** light, **SHARPER** images. Sun shade. "Diamond cut" focusing ring. New focusing arm for hairline adjustments. **PRISMATIC. Hard Coated.** Grey crackle finish. Field at 1000 yards is 32-122 ft. 15" long. Scope weighs 28 $\frac{3}{4}$  oz., tripod 14 $\frac{1}{2}$  oz. **COMPLETE** with 5 eye pieces, adjustable tripod with plush lined leather case with divider. **\$150.00**

**FIRST WITH THE BEST**



# WHERE PRICE AND QUALITY ARE UNITED

## YOU BE THE JUDGE

UNITED'S business is based on pleasing the customer. Nothing is spared to assure giving you the customer absolute satisfaction. UNITED realizes that a good per cent of sales are satisfied repeat customers and from people they in turn refer to us. UNITED'S tremendous volume is based on giving **More Quality at Lower Prices.**

## BINOCULAR "KNOW HOW" SINCE 1936

You want, and should insist on getting, the **BEST-BY-TEST** Binocular for your purpose. UNITED has served over 1,100,000 sportsmen the country over. Each year more and more UNITED DEALERS are being added to our list. We Know what sportsmen require. We hear it from our dealers and every year thousands of outdoor enthusiasts tell us in person at our Chicago display room, or tell us in writing of the good results they have been getting with their UNITED Binoculars. UNITED anticipates needs and fills the wants of the most discriminating user. UNITED has for years been a pioneer in introducing new optical achievements to the American public. If you have any special problem please feel free to write to us.



## Sold to Leading Institutions

Colleges from coast to coast use UNITED Binoculars. All colleges require **QUALITY AT THE RIGHT PRICE.** That is why we at UNITED so value their repeat sales. A governmental department tested a pair of UNITED Binoculars, found them such a value they bought forty additional pair for an expeditionary trip! This should not be construed as a governmental endorsement of UNITED Binoculars for that is forbidden but it does show **QUALITY AT THE RIGHT PRICE.**

## OVER 100 Models From All Over the World

You find over 100 models listed in these catalog pages. Hundreds of other makes, powers, etc., were tested and rejected. UNITED'S test include binoculars from United States, Japan, Germany, Switzerland, etc. Those shown are the "**BEST-BY-TEST**" **PRICED RIGHT** binoculars we found. By selling only the best buys UNITED has become "America's Leading Binocular Retailer."



"American Rifleman"

"True"

"American Legion"

## Leading Publications Approved

UNITED binoculars are regularly sent to outside sports authorities for their impartial, unbiased comments. Such outside opinions from unprejudiced experts provide added protection for UNITED customers. Ask any leading outdoor magazine about UNITED—they know.

## United Seal of Quality

Make sure the binocular you buy bears this seal. It is your assurance of top optical performance. It tells you that the binocular has satisfactorily met every UNITED test for size, power, weight, performance, and price. Don't be satisfied with less or pay more. **BUY UNITED—AND BE SURE!**



**MB**



# Buy - Try UNITED AT OUR RISK





From **AUTHORITIES** who  
know **BINOCULARS**

American Rifleman official publication for the National Rifle Association recently tested 3 of our binoculars under average field conditions and reported "Featherweight—the optics are very good—moderately priced—will serve general purposes—a good buy for the money . . ."

Sports Afield "Colonel Townsend Whelen, our camping editor thinks very highly of your binocular. It so happens he had a reader query on them and we are using his favorable reply in this department. . . ."

American Legion Magazine describing a UNITED binocular, wrote "Now you can get close-up views of sports events, wild life, etc., Thanks to radically different design, etc., offered by UNITED, Chicago.

Southern Governor of one of the leading states in America has repeatedly bought binoculars from UNITED.

Warren Page, Shooting Editor, Field & Stream, "From what experience I have had with them, there is no doubt but what both sets of glasses (7x35 and 8x40) are of excellent quality both optically, mechanically . . ."

Hunting & Fishing, publisher, L. F. McClure, tried our UNITED "Vest Pocket" binoculars, immediately liked them, and bought a pair for his personal use.

National Advisory Committee for Aeronautics specified, "United Binocular Co.'s binoculars or fully equal."

Ted Kesting, Editor, Sports Afield, "Colonel Whelen, Camping Editor, thinks very highly of your binoculars . . ."

Western Sportsman Magazine, "The UNITED people are making one dickens of a good price on a 16x50 featherweight glass that ought to be down a sportsman's alley. Looks like a good buy to me."

**AIRMAIL SERVICE!**

WE ARE PREPARED TO SHIP ANY BINOCULAR SAME DAY BY "AIRMAIL"

Add the Following Airmail Charges When Ordering

- All Pocket Models, Rifle Scopes and 30X Telescope . . . \$1.00
- 6 or 8 Power, 15-40X . . . \$2.00
- Wollensak Telescope . . . \$3.00
- 7, 10, 12, 16, or 20 Power 15x65 . . . \$4.00



**BUY UNITED AND BE SURE!**



# United German PRECISION BINOCULAR



**6 x 30**

**8 x 30**

**MB**

**WEIGH ONLY  
15 OZS! !**

**BOTH are CENTER FOCUS with Individual Focusing Right Eye**

Germany has for generations been known as the Optical Center of the World. The entire world has long recognized and admitted the superb craftsmanship, fine optical qualities, matchless performance, dependability and ruggedness of German made binoculars.

UNITED is proud to announce that now, precision machined, optically perfect GERMAN BINOCULARS are available in the United States at UNITED'S popular prices! Their "Whisper Weight" will amaze you (only 15 ounces). All internal optics are Coated! They are center focus with individually focussing right eye piece. All Carry the usual UNITED "Seal of Quality" etched in their frames.

**6x30** 390' field  
4 inches High **\$55.00**

**8X30** 450' Wide Field  
4 3/4" High **\$59.50**

Fine German Leather Case and Straps Included with Both.



**8 x 30 Economy — 10 3/4 ozs.**

One of the World's Lightest! It's "Whisper Weight" and exceptional compactness (4"x5 1/4") makes using it a rare treat indeed. Excellent 360 ft. field. These fine German Binoculars assure you of brighter, sharper images. **Center focus** with individually focusing right eye piece. Includes Fine Leather Case, Straps. **\$39.50**



**QUALITY SELECTION FROM THREE CONTINENTS**



# "United" German

# WORLD'S FINEST!

## 7x35 - \$69.50

ONE OF THE LIGHTEST 7x35  
ON THE MARKET

Its ultra precision GERMAN craftsmanship is apparent at a glance and its pleasure of performance is felt the instant you put them into use. Made with "Whisper Weight" Aluminum Alloy Bodies. All internal optics have been coated with magnesium fluoride.

CENTER FOCUS—17 $\frac{3}{4}$  OUNCES  
LENS ARE GERMANIA GLASS

Germania Glass is world famous for its Good Optical Qualities and its fine light transmitting power. Has the giant field of 390' at 1000 yards. Binocular is only 6" high. Water-Dust resistant. A tremendous value at \$69.50, which price, includes fine leather carrying case and straps.



## 7x50 Center Focus German - \$99.50

Aluminum Body-Weighs  
Only 36 Ounces

Top quality thru-out. The optics are Germania Glass, world famous for better performance. Aluminum body assures greater durability, "whisper weight." German craftsmen, indoctrinated since childhood in precision optical craftsmanship, designed and manufactured this wonderful glass. UNITED's tremendous volume Brings You This Fine binocular At An Economy Price.

Exit Pupil 7.1 mm - Light  
Transmitting Power 50.4

384' field at 1000 yards. Center focus with individually focusing right eye piece. 7" high. Water-Dust resistant. All internal optics COATED with magnesium fluoride. As do All Our Binoculars Carries Famous UNITED "Seal of Quality" etched into Frames.

MB



Comes complete with beautifully made sturdy German leather case and straps.



## WHERE PRICE AND QUALITY ARE "UNITED"



# "United" German

# HIGH-POWERED



**20 x 60**

**CENTER FOCUS**

**EASY TO HOLD**

**EASY TO FOCUS**

**\$189.50**

### **Weighs Only 37 Ounces**

One of the finest binoculars we have ever handled. They offer Everything. Made to rigid UNITED requirements in Western Germany. Check these features.

### **POWER**

Tremendous power . . . brings objects 20 times closer to you. Made in Germany by men trained from childhood to do precision optical grinding and binocular assembly. This superb glass gives you POWER . . . all you need . . . whenever you want it and at your finger tips . . . for its size it is only 7x8<sup>3</sup>/<sub>4</sub> inches! Field of 160 Feet at 1000 yards.

### **PERFORMANCE**

This glass will give you the absolute acme of power-performance regardless of whether it is morning, noon or night for it has been precision constructed and scientifically engineered to give you Peak Power-Performance at All Times.

In addition to their center focus, they also have an individually focusing right eye piece. Come in usual handsome leather carrying case, complete with straps.



### **CONSIDER THE PRICE**

It is almost impossible to believe that you could have so much of a Binocular at so low a price. Our suggestion is that you purchase a pair on our 30 Day Free Trial Offer and prove it to yourself.

### **GERMAN HIGHPOWER**

*"The 20 Power German \$159.50 glasses I received are terrific! I get depth and perception for at least one mile!"*

**D. P., CONN.**

*"They are sure swell. So easy to use . . . a real pleasure."*

**F. E., IOWA**

*"We are all convinced of the quality, terrific clarity, tremendous power and field of view for such a jumbo glass of amazing light weight. I am very proud to own such a precision optical instrument and its handsome case."*

**D. K. T., PENNA.**

**APPROVED BY LEADING SPORTS PUBLICATIONS** 23



# 20 POWER UNOCULAR

## 60MM OBJECTIVE LENS!



**\$44.95**



Sturdy Case and Straps Included

**DEFIES COMPETITION!**  
**INVITES COMPARISON!**

Here is why you should first try the United Achromatic UNOCULAR. You get twice the power (20 Power)! You get an objective lense that's 20% greater in size (60MM)! Less weight (20 ounces)! Less bulk (only 8½" long)! The UNOCULAR (Half an expensive binocular) is a precision machined, scientifically ground PRISMATIC optical masterpiece. It NOW costs so little you really cannot afford to be without it. A delight to use and a delight to own.

### GUARANTEED 10 YEARS!

#### Engraved SILVER HAWK

AMAZING OFFER—We call this rugged engraved knife the Silver Hawk. A great knife for the hunter, fisherman or collector. Highly polished 6" blade has detailed, richly engraved outdoor scene showing a charging elk. This beauty has a fancy curved finger guard; carved stag handle is capped with a handsome Silver Hawk's head.



**\$2.49**

With leather sheath. IF BROKEN WITHIN 10 YEARS WE WILL REPLACE AT NO CHARGE. Only \$2.49 plus 75c postage & handling.

#### Survival Knife \$5.99

BIG VALUE. A large 9½ inch knife with 5 inch blade. Broad blood groove. Back of knife has sharp saw teeth. Handle is sure-grip, aminated leather and grooved. Top of handle has heavy plate so can be used as emergency hammer. Natural leather sheath, riveted and sewn with sharpening honing stone in pocket. Comes with leather thongs to attach to waist and leg. RUGGED STURDY AND RELIABLE.

Add \$1.25 postage, handling.

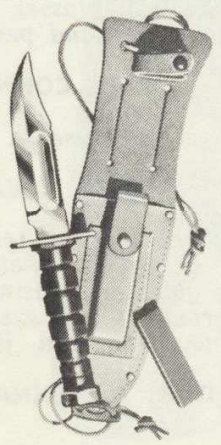

### Finest Have Ever Used



Our thanks to Mr. Don Plummer of Milaca, Minn. for the following letter —  
"Enclosed find check and order for more 7x35 Super Wide Angle Binoculars. These are the finest I've ever used . . . ."



24 **UNITED GUARANTEES YOUR SATISFACTION**



# BAUSCH & LOMB



**MB**

## Among the World's Finest



Unexcelled American made optical quality—reveals distant detail unseen through ordinary binoculars. Optical specifications checked at 5 times human vision for any variation. Zephyr-Light **magnesium** construction (excepting 7X50 made of aluminum for prolonged water immersion). Hard rubber body covering so durable it cannot be removed except with a grinding wheel. Hand-lapped and diamond-turned moving parts for unchanging

smoothness and precision. Permanent correct alignment by exclusive prism mounting method. Balcote anti-reflection coating. Bausch & Lomb is the only manufacturer in the world who has continuously produced prism binoculars since their invention. Guaranteed without qualification against defects in material or workmanship.

Model	Magnif. Power	All come in Center Or Individual Focus, except 7x50 which is Individual Focus only. State choice when ordering.	Front Objective Diameter	Linear Field at 1000 yds.)	Relative Brightness	Length closed	Length open	Weight	List Price
6X,30 With case, straps.	6X		30mm	445	25	4¾"	5½"	17 oz.	\$259.00
7X,35 With case, straps.	7X		35mm	382	25	5⅝"	6"	19 oz.	\$269.00
7X,50 With case, straps.	7X		50mm	381	50.4	7⅞"	77/16"	48 oz.	\$349.00
8X,30 With case, straps.	8X		30mm	445	14.4	49/16"	4 15/16"	18 oz.	\$279.00
9X,35 With case, straps.	9X		35mm	382	14.4	57/16"	5 13/16"	20 oz.	\$289.00

### 25 Year Guarantee 7x35 631 FT. WIDE ANGLE

### Magnesium!



New ideas abound in every detail of this new model. One of the most superb optical instruments ever designed . . . a new standard by which to judge. New, modern, streamlined body balances perfectly in your fingertips, virtually eliminating fatigue. A new optical combination incorporates exclusive UVC ultra-violet coating with high-intensity BAK-4 prisms. An optical system so superior, that a single glance will convince you of the quality. So painstakingly constructed these glasses carry an exclusive 25 year guarantee. Adjustable eyecups rotate to provide perfect eye-relief WITH OR WITHOUT glasses. Center focusing wheel is protected within the **MAGNESIUM LIGHTWEIGHT** body. Newly designed leather case is enhanced by chrome trim. 12 degree prisms give you a **WIDE ANGLE** field of 631 feet. Brightness factor is 43.5. 5½ inches high. Weigh but 30 oz.

**\$150.00**

Written 25 year guarantee enclosed with each instrument.



**CENTRALLY LOCATED FOR FASTER SERVICE** 25



# Try Any Binocular for 30 Days at Are Not Fully Satisfied Return

**MB**

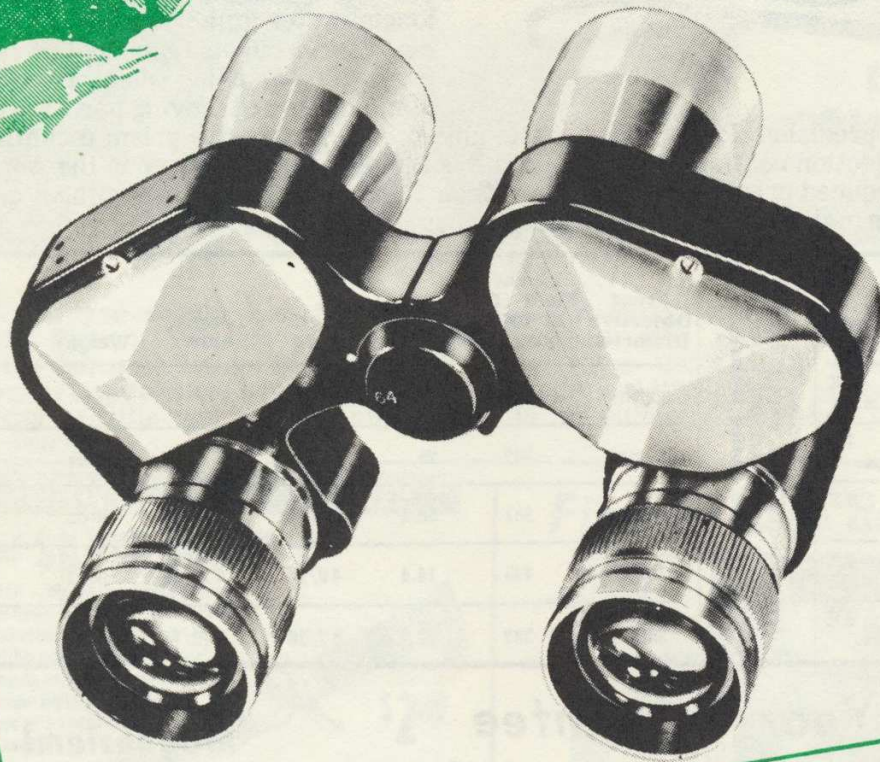

**Another  
UNITED  
FIRST**

## **7 POWER** **WIDE ANGLE POCKET**

**525 FOOT FIELD!**

In the creation of UNITED'S New 7 Power WIDE ANGLE Pocket Binocular, our Optical Craftsmen achieved what seemed to be the impossible. Experts said it could not be done, that bulk and weight were an optical necessity in order to create a WIDE ANGLE Pocket Binocular.

Our Optical Engineers spent many months testing, checking, creating and rejecting ideas and models until the day finally arrived when a model was created to meet rigid UNITED requirements.

This fine quality 7 Power Pocket WIDE ANGLE Binocular measures only 3 x 4½ inches and weighs but 15½ ounces. It has 25 mm. front lens and gives a WIDE ANGLE Field of 525 feet at 1000 yards; Lustrous satin chrome with glossy black trim. Comes in handsome plush lined case, complete with straps. Individual Focus. Lense hard coated!

**\$39.95**

**7x25 — \$59.95**

**WIDE ANGLE but Center Focus with individual Focusing Right Eye Piece.**



# TRY ONE MONTH AT OUR RISK



# Our Risk and Expense - - - If You for Prompt Refund in Full!

**MB**



## 15x65

**CENTER  
FOCUS**

## \$99.50

**STRONG, DURABLE ALUMINUM ALLOY FRAMES!**

The wanted binocular. Tremendous power, brilliant illumination, has light transmitting power of approximately 19—almost as much brightness as a 7x35! Wide field of view. Streamlined designing plus lighter, stronger metals makes this 15 power glass easier to hold and use than many glasses half its power! Water-dust resistant. 8½"x9" — 51 oz.

### **GIANT FRONT LENSE ALMOST 3 INCHES ACROSS**

Objective lenses are giant size—65 mm. . . . Almost 3 inches across. COATED lenses for crisper, sharper images — made by skilled optical craftsmen in Japan. 30 DAY NO RISK TRIAL. Return for refund if dissatisfied. Center focus with individual focusing right eye piece. Handsome case, straps, included.

*"I have given my 15x65 binoculars test after test for long range use, such as spotting Jet Planes etc. These are quickest focussing glasses I have ever owned and pin-point, ultra sharp, at ranges to the moon. At 200 ft. from top of mountain I could see Ephrata, 32 miles away and air was hazy. My old 20x50 could not do this. Thanks for selling me such a perfect glass."*  
**Mr. William T., Ephrata, Penna.**

**20x65 - \$109.50**

Same as above photo but with 51 oz. Aluminum alloy frame.



**20x60 - \$89.50**

Same as above photo but with 51 oz. Aluminum alloy frame.

# A LIFETIME OF PLEASURE



# 7x35 MONOCULAR

**\$37.95**



Measure only 2½x4¾". Weighs 8½ ounces! A monocular is HALF of a PRISMATIC Binocular. An ideal glass for hunters, sportsmen, vacationers, etc., because of its compactness, size and weight. Made in Japan. Easy to carry and simple to use with one hand. Coated lense! Fine Leather case and straps.



**7x50-\$39.95**

# CROSSBOW

Complete outfit  
**\$49.95**



**USE 30 DAYS AT OUR RISK**

Crossbow Shooting — the exciting modern sport. Kill game, do backyard target shooting, even crossbow fishing. Powerful 80 lb. thrust shoots arrows "like bullets". Easy pull. Aims like a rifle, has adjustable Open and Peep Sights with windage and elevation adjustments. Powerful — Silent — Accurate. Handsome, polished hardwood stock. Steel trigger. Aluminum bow. Automatic safety lock. Simple instructions. Ready to use. Crossbow plus leather quiver, 1 hunting, 2 target arrows and fishing harpoon with free-line attachment. Add \$2.50 for shipping.

# 30X TELESCOPE



**High Power Low Price**

Use for trips, sports, vacations etc., 30 power. Featherweight 6½ ozs., Only 7½ inches closed, 14 inches open. Precision machined. Chromed draw tube. 30mm front lense. All Metal. Achromatic. Internal lense Surface Coated. Durable. Leather case. Add 75c each postage, handling.

**\$19.95**

# 8x40

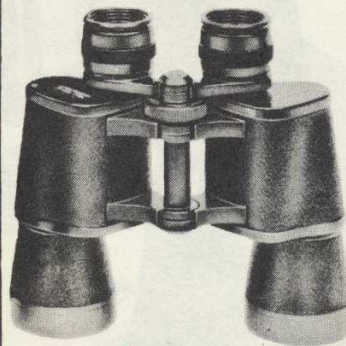

**\$49.95**

Distant images appear so clear you feel you can almost reach out and touch them. 8 Power with sharp 40mm (over 1½" across) front lense. For sports, vacations, etc. CENTER FOCUS. 341 ft. field. 24½ oz. Coated lense. With case, straps. **GOOD QUALITY — LOW PRICE!**

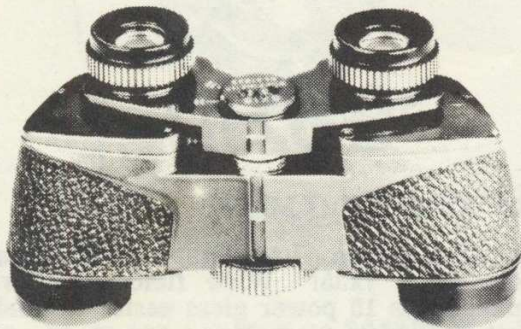

**POWERFUL, COMPACT W-I-D-E A-N-G-L-E**

6x18 WIDE ANGLE. A new achievement in binocular design. Panoramic WIDE ANGLE 578 ft. field, usually found in binoculars twice this size! Finest in lightweight viewing enjoyment. Unusual compactness with powerful 6x magnification. Only 2¾" high and weighs but 13 oz. Exclusive UVC optics add brightness. Center focusing. 18-mm. lenses. Luxurious, black zippered case included.

**\$59.50**

# Theatre Glass

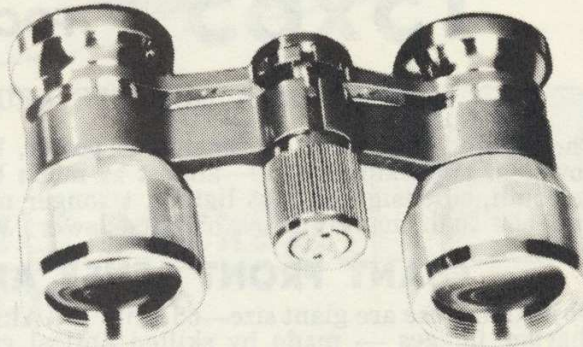

**3X**

**CLASSIC ELEGANCE FOR THE THEATRE.**

Mother-of-pearl luxury set off by gold trim! 3X Theatre glass. Height is only 2 inches and weighs but 4 ozs., Coated optics. Standard Center Focus. In rich satin-lined red PERMANENT gift box. Zippered leather case.

**\$39.95**



**UNITED GUARANTEES YOUR SATISFACTION**



# 15-50 Power Z-O-O-M

With United's new ZOOM Spotting Scope you can set the power, at let us say 15, and **without removing your eye from the eyepiece** ZOOM up to 20, 30, 40 and 50 power (or any in-between power) . . . . . with a simple twist of your fingers.

This PRISMATIC scope has **large** 60mm (2½ inches across) front lense for greater light transmission with resulting brighter viewing.

TURN EYEPIECE TO POWER WANTED . . . . . YOUR IMAGE IS **RIGHT THERE** — IN SPLIT SECONDS.

Hard Coated optics. Adjustable Sunshade. The Micrometer adjusting arm permits the scope to be turned up, down, right or left the **barest fraction** assuring extra precision adjustments. Fine field of view of 35-79 ft. at 1000 yds. Scope weighs 41 oz. tripod 19 oz. Is 16¼ inches long. Rich grey crackle finish with handsome chrome trim. Focusing ring is "diamond cut" for that "extra quality" look. This new model represents another step forward in fine quality United optical instruments.

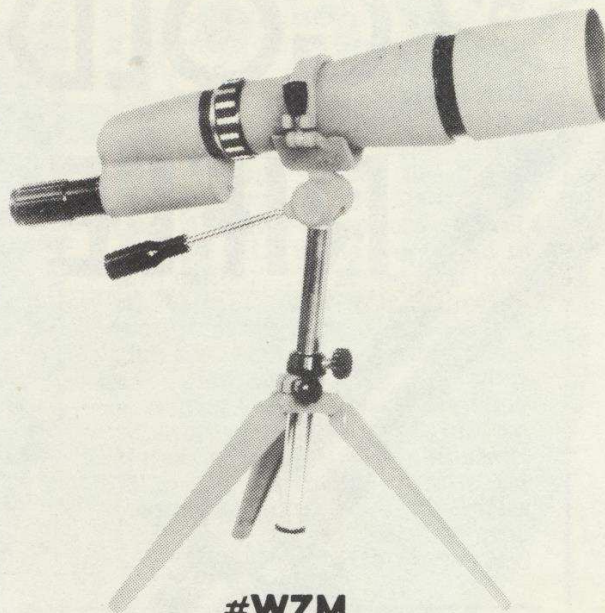

#WZM  
\$99.50

# B-I-G 4¼ Inch Lense Give BRIGHTER IMAGES

## 15 to 60 POWER

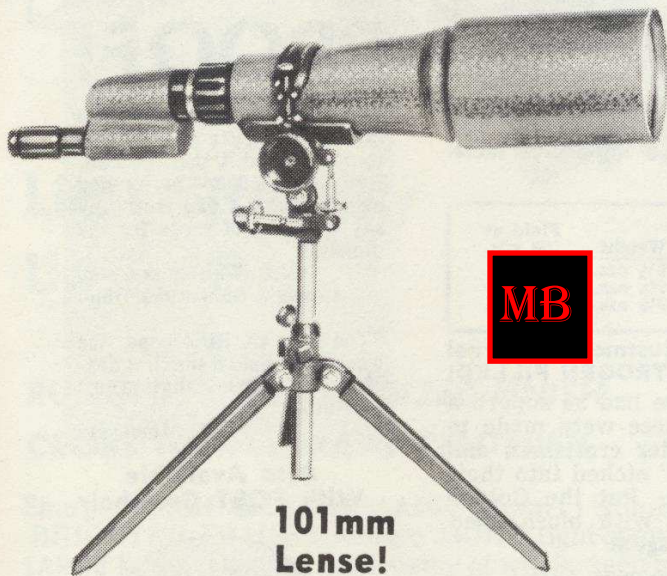

**MB**

101mm  
Lense!

\$325.00

This is United's finest PRISMATIC Spotting Scope combining into one superb instrument the best in materials, engineering and craftsmanship. **Big 101mm** front lense (4¼ inches across!) assures you **sharper, MORE BRILLIANT** images. Advanced optical engineering is necessary to manufacture lense measuring 101mm (4¼ inches) in diameter; however the **larger** the front lense the **GREATER** light which passes through the optical system . . . . . resulting in images in **FINER DETAIL** . . . . . permitting you to **SEE MORE**.

### Micrometer Adjustments

Comes with expensive Micrometer adjustments on the tripod enabling you to make **minute** adjustments in sighting. Complete with 5 eyepieces 15, 20, 30, 40 and 60 power in dust-proof plastic container which can be interchanged as you wish, in seconds. Field of view at 1000 yards is 30½-75 feet. Scope weighs 70 oz. and adjustable tripod 44 oz. 23⅝ inches long. Hard Coated optics. With Sunshade and screw-in protective lense cap. Rich chrome trim. Handsome grey crackle finish. **FINEST** United quality! Model #WVT.



**BUY UNITED AND SAVE**



2½x  
4x  
6x

# GOLDEN HAWK RIFLE-SCOPES

**MB**

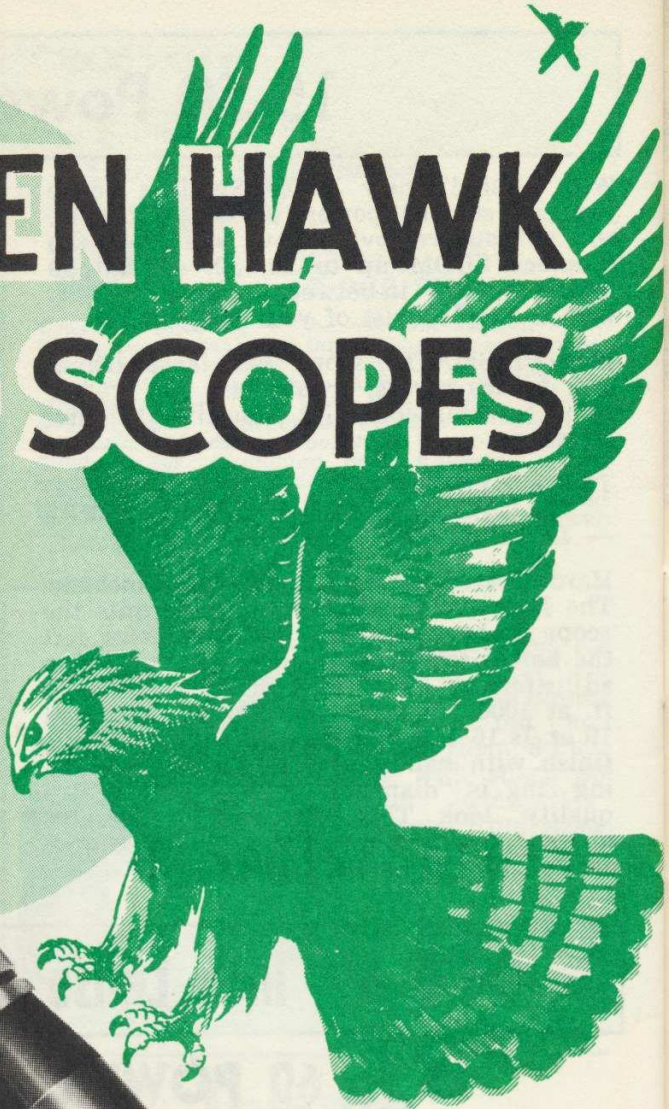

**RUGGED  
ANODIZED FINISH  
ALWAYS CENTERED  
CROSSHAIR RETICLE**

If you only had one shot, while hunting, you would want the UNITED Golden Hawk. You wouldn't want a finer riflescope. Words don't do Golden Hawk Scopes justice. You have to use these Fine Scopes. We will gladly ship you a Golden Hawk on a 30 Day Trial basis. If dissatisfied return anytime within that period for a full refund.

**WEIGH ONLY 9½ OZS!** Golden Hawk Riflescopes are hard COATED thru-out . . . every lense surface! Have cross hair reticle. Are water-dust resistant. Check these important facts:

**SPECIFICATIONS**

Model	Length	Tube Dia.	Exit Pupil	Weight	Field at 100 yds.
2½ Power 32 mm	11⅞"	1"	12.6 mm	9½ ozs.	33 Feet
4 Power 32 mm	11⅞"	1"	8 mm	9½ ozs.	30 Feet
6 Power 32 mm	11⅞"	1"	5.3 mm	9½ ozs.	20 Feet

Handsomely blued thru-out. Double adjustment (Internal windage and elevation with click stops.) **NITROGEN FILLED!** Never before in UNITED'S history have we had as superb a trio of riflescopes to offer the public. These were made to the finest of tolerances in Japan by master craftsmen and bear the famous UNITED "Seal of Quality" etched into their frames. We want you to test our claims. Put the Golden Hawk to every test. They won't fail you. With plush lined lense caps. United scope mount \$9.99. See page 38.

Prices In This Catalog Are Suggested List.

**4 x - \$44.50    6 x - \$54.50**

**2½ x - \$39.95**



## PROOF!

"We mounted this scope on an 8 MM Mauser rifle and our customer wanted it shot for him. Results, this scope performed excellent and I can truthfully say it's a lot of scope for the money."

**J.R. Whiteman & Son,  
Dealer & Gunsmiths, Ohio.**

"The first 4X Riflescope was wonderful. Sold it the first day. Makes a dandy installation on a Marlin 336."

**R.T., Minnesota**

**Also Available  
With POST Crosshair**

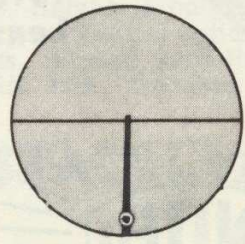



## United Wins Blue Ribbon



Gun Craftsman George L. Carpenter of George's Gunsmithing in Minneapolis, Minn. received the Blue Ribbon with a United scoped prize winning rifle at the Minnesota State Fair. George writes us—" . . . this gun was a FN Mauser action, Douglas premium barrel, stocked with Yama wood and in .270 caliber. The scope is a United variable and the engraved mount rings are United. This gun has been shown at numerous gun shows and everyone checking the rifle says the United scope has wonderful clarity. Makes a beautiful combination. This has created a desire for customers to have their rifles United equipped." *Our congratulations to Gunsmith Carpenter!*



## United's GOLDEN GRIZZLY

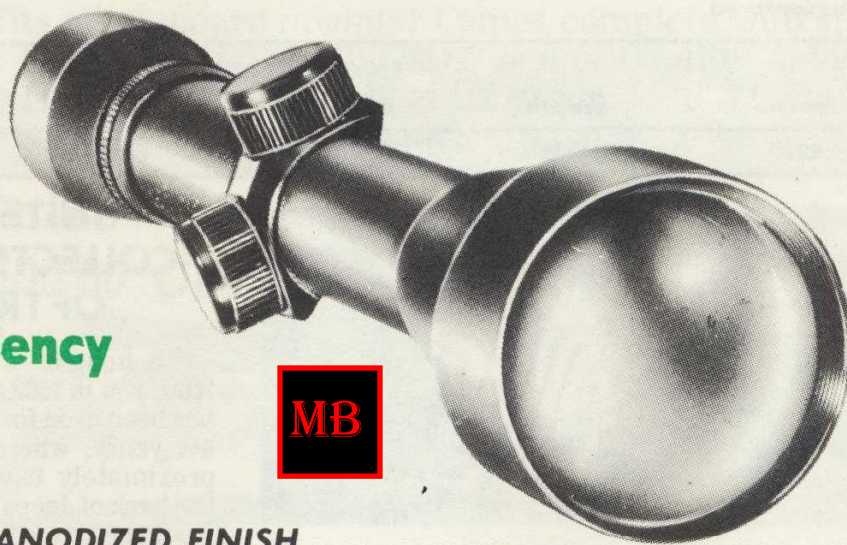

**Light Efficiency  
Up To 256!**



**RUGGED, RICH ANODIZED FINISH  
CROSS HAIR ALWAYS CENTERED**

Sharper **BRIGHTER** Images! **LARGE 40mm (1 1/2 inches across)** front lense give you sharper **BRIGHTER IMAGES** because **MORE** light comes thru the optical system due to **EXTRA LARGE lense**. What you are looking at will be seen in greater detail especially so under bad lighting conditions, during murky days and at dusk. **LIGHT EFFICIENCY — 2 1/2 x40 — 256, 4x40 — 100, 6x40 — 44.** Weigh 11 ounces, 11 7/8 inches long. Cross hair reticle. Windage and elevation adjustments with **positive** click stops. Hard coated. **NITROGEN FILLED.** 1 inch tube fits United (see page 38) and all standard mounts. With plush lined scope caps. **Field 100 yards: 32, 28 1/2 and 18 1/2 feet.**

Prices In This Catalog Are Suggested List.

**2 1/2 x40 — \$47.50**

**4x40 — \$47.50**

**6x40 — \$55.00**





# "United's" LATEST

## GOLDEN CONDOR

Rugged Anodized Finish



**4 POWER \$24.95**

### New Improved 9 LENSE Optical System

The UNITED GOLDEN CONDOR invites comparison. To begin with, it is a full 4 POWER. Has metal cross hair reticle. Factory adjusted parallax. It's Water-Dust-Shock proofed. Has internal Elevation and windage adjustments. Entire optic system 100% Hard Coated for brilliant, sharp viewing. Eyepiece lense 30 MM! Its 1" tube fits all standard mounts. Weighs only 6½ ozs. NITROGEN FILLED! United scope mount \$9.99. See page 38. Cross hair always centered.

Model	Length	SPECIFICATIONS		
		Exit Pupil	Weight	Field 100 Yards
4x20	11½"	5mm	6½ ozs.	29



### UNITED SCOPE COLLECTS WALL FULL OF TROPHIES

"I bought a United Rifle scope from you in 1962 and since that time it has been used for hunting in Africa for 4½ years, where it was carried approximately 15,000 to 20,000 miles in the back of Jeeps and Landrovers, and would be afraid to guess the number of

miles I've carried it walking. Needless to say it has had some bad jolts and shaking up over some of the worst roads, trails and cross country treks from sea level to 10,000 feet. . . It has been twice to Africa by ship.

Also, I have used it in the States hunting both on foot and horseback and I must say that this scope which is a 4x32 Golden Hawk has given me service I did not think possible for the price, which I purposely paid because of the rough treatment that I knew it would receive. Outside of minor adjustment, which were seldom, I have used it with confidence and through this confidence I have collected quite a wall full of trophies from Africa and the States and am looking forward to several more years of use out of it as it has become an inseparable of my favorite .30-06 rifle. . ."

Mr. J.D. "Bill" Potter, Alexandria, Virginia.



WHERE PRICE AND QUALITY ARE "UNITED"



# New, 3x, 4x, 5x, 6x, 7 POWER! UNITED'S *Variable* RIFLESCOPE



*The* GOLDEN EAGLE

**LATEST  
 DESIGN**



**MB**

**RICH ANODIZED FINISH  
 CROSS HAIR ALWAYS CENTERED**

**\$79.50**

Prices in this catalog are suggested retail list.

Instantly turn to the Power you want... 3, 4, 5, 6, or 7 power. Double adjustment (Internal Windage and Elevation), 32 mm objective lens and 32 mm eyepiece. Cross hair reticle. Weather resistant. Hard coated

thru-out. 1" tube fits all standard mounts! Comes complete with sturdy Scope Lense Caps. Carries famous UNITED "Seal of Quality." Made in Japan Weighs only 11¼ oz. 13" long. Field at 100 yards: 33 to 17¼ ft. Click stop adjustments! United Scope Mount \$9.99. See page 38.

*Golden Eagle Mounted on  
 \$500.00 Custom Made Rifle*

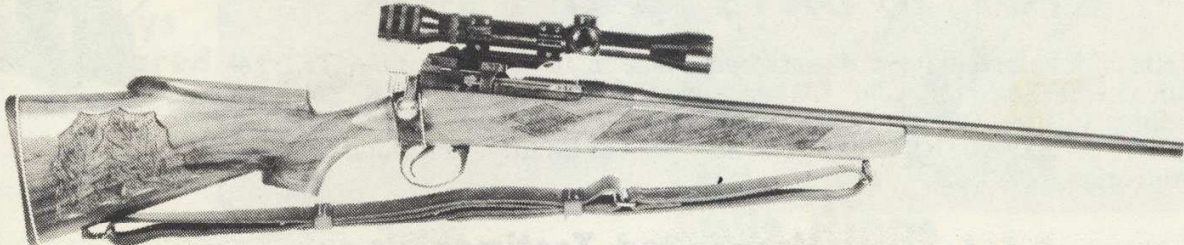

"Enclosed find photo of the 3X-7X "Golden Eagle" Variable mounted on a \$500.00 rifle. The mounts, rings, floor plate, trigger guard, safety lever and screws are plated with 24 karat Gold.

The stock was carved from imported French Walnut with an Oak Leaf and Acorn design. The grip cap and fore end were cut from the root of Missouri black walnut stump. Every customer for whom I purchase a UNITED scope has been more than pleased. Business is looking much better and I of course will be using more UNITED scopes."

**Mr. R. D. Baker, Gunsmith, Maywood, California**



**APPROVED BY LEADING SPORTS PUBLICATIONS** 33



# United's GOLDEN FALCON VARIABLE RIFLESCOPE!



Enjoy 4x, 5x, 6x, 7x, 8x and 9x

LATEST  
DESIGN

MB



**Rugged Anodized Finish  
Cross Hair Always Centered**

Instantly turn to the power you want . . . 4, 5, 6, 7, 8, or 9 power. Double Adjustment (internal windage and elevation). BIG 40mm front objective lens to give you MORE LIGHT! 32mm eyepiece lens. Cross hair reticle. Weather resistant. Hard Coated thru-out. 1 inch tube fits all standard mounts. Comes complete with Scope Lens caps. Click stop adjustment! NITROGEN FILLED.

**SPECIFICATIONS —**

Weighs only 12¼ ounces, 13½ inches long. Field at 100 yards: 29½ to 14 ft. United Scope Mount \$9.99. See page 38.



## TEST, USE AND COMPARE FOR 30 DAYS AT OUR RISK

Return for refund in full if dissatisfied. Made in Japan to rigid UNITED requirements. Since 1936 UNITED has made this NO RISK OFFER. You have nothing to lose. Our confidence in UNITED QUALITY GUARANTEES YOUR SATISFACTION! The UNITED "Seal of Quality" trademark is your protection.

### Unsolicited Testimonials

"Please rush a 4X Rifle scope with 1" tube. Money order enclosed. The other 2 Variable Power Rifle scopes I got really were well liked by customers who received them. I'm going to use the above for myself personally on a Johnson semi-automatic this year."

Ray's Gun Repair, Wisconsin

"All your rifle scopes have proved more of a value than all others. The adjustments are most reliable . . ."

Tom's Gun Shop, H — S —, Ark.

"At the present, we could sell three more scopes to friends of the first two customers."

J. B. E. —, Pa.



MODEL WBN — **\$89.50**

**THIS SEAL PROTECTS YOU!**



For the *FIRST TIME*  
**HAND ENGRAVED SCOPE**



**4 x 32**

**Silver Hawk**

**\$89.50**

Model #WE4X

Silver Hawk owners are the envy of riflemen who appreciate master Craftsmanship. Combines superb optics and hours of precision hand tooling. Richly engraved by hand with interlocking scroll design.

Cross-hair reticle. **NITROGEN-FILLED.** 4x32. Weighs 9½ oz. 11¾" long. Field 30'. 1" tube fits **UNITED** and other standard mounts.

**FULLY HARD COATED.** Windage, elevation adjustments, with positive click stops. Plush lined scope caps included. Enriches any rifle. Hand engraved rings shown in photo **not** included. See below.

**Always Centered Cross hair**



**Hand Engraved Split Rings . . .**

**The PERFECT Combination**

The 4x32 Silver Hawk described above and the Hand Engraved Split Rings will add prestige to any rifle. The interlocking Scroll Design matches one with the other . . .

Truly a proud possession.

Completely Hand Engraved on **ALL** sides — no 2 sets are exactly alike. Beautiful interlocking Scroll Design.

Hours of Customized Craftsmanship are needed to complete just one set of these rings. A handsome addition to any scope and rifle. Featherweight and durable.

Will fit United, Weaver and similar 2 piece bases. Model #WEM. **\$18.95** SET OF 2

**NO TWO EXACTLY ALIKE!**



# UNITED'S GOLDEN PLAINSMAN



## 3 to 12 Power Variable

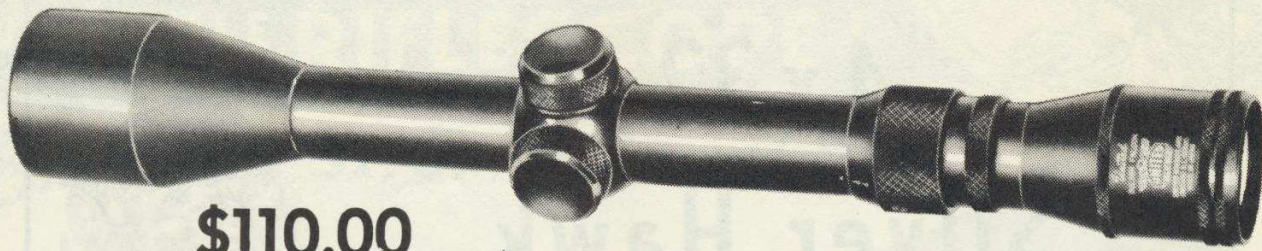

**\$110.00**

United Scope Mount \$9.99. See Page 38

GIANT 40 MM Objective lens for MORE light, SHARPER images! For every type of shooting. The power range is greater 3, 4, 5, 6, 7, 8, 9, 10, 11, and 12 Power! The definition is excellent. The satisfaction the greatest. To see it is to want it. Finger-tip power control. Weather resistant **NITROGEN FILLED**. Cross hair reticle. Internal Windage, Elevation adjustments. 1" tube fits all standard mounts! **Hard coated thru-out. SPECIFICATIONS.** Weighs 12 $\frac{3}{4}$  oz.; Length 13 $\frac{1}{2}$ ". Field at 100 yds. 33 to 12 $\frac{1}{2}$  ft. Price includes fine Scope Lens Caps.

## NEW-Precision Brand by United

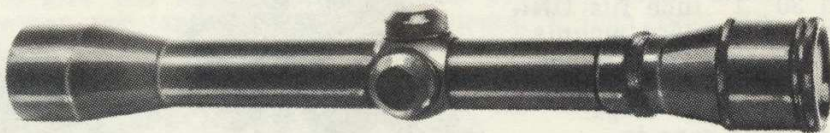

**2 1/2 x32 - \$33.95**

**4x32 - \$39.95**

**6x32 - \$49.95**

**10x32 - \$59.95**

**3-9x40 - \$69.95**

Pay less with good quality **PRECISION Brand Name Scopes**. All optics **Coated** with Magnesium Fluoride. Color corrected. **Nitrogen filled—fog proofed**. Water, Dust resistant. Standard 1" tube fits **all** mounts and **all** rifles. Internal Windage and Elevation adjustments with click stops. Always centered cross hair reticle! 32 mm rear lens, Parallax adjustment. Eye relief 3 $\frac{1}{2}$ " 28 $\frac{1}{2}$  ft. field (6x32 is 20 ft.) Weigh 10 oz., 11 $\frac{3}{4}$  inches long.

Use one scope for all types of shooting — short or long range, target, varmint, and hunting. New **PRECISION Brand Name 3-9X** variable with **BIG 40MM FRONT LENSE** (Over 1 $\frac{1}{2}$  inches across) to give you **MORE LIGHT** meaning your images will be **clearer and sharper**. **DO NOT CONFUSE** with 3-9X with **SMALLER 32mm** front lens. All optics **Coated. Nitrogen filled-Fog proofed**. Water, dust resistant. Standard 1 inch tube fits **all** mounts and **all** rifles. Internal Windage and Elevation adjustments with click stops. **BIG 40mm** front lens (over 1 $\frac{1}{2}$  inches across). 32mm rear lens. Always centered crosshair reticle. Parallax adjustment. Eye relief of 3 $\frac{1}{2}$  inches. Field 31-12 ft. Weighs 12 $\frac{1}{4}$  oz., 13 $\frac{3}{8}$  inches long.



**SOLD ON A MONEY BACK GUARANTEE!**



# 1½x to 4x GOLDEN COUGAR

*Variable*

## Light Efficiency Up To 117

**NEW VARIABLE.** Greater light efficiency gives you brighter pictures. Especially desirable for shooting at dawn or dusk or under adverse light conditions. **Light Efficiency is 1½X-117, 2X-100, 3X-45, 4X-25.**

**MB**

**Cross Hair Always Centered  
Rich & Rugged Anodized Finish**

Weighs 10½ oz. 12½ in. long. Eyepiece lense 32mm and front lense 20mm. **Hard Coated thru out.** Cross hair reticle appears same size at all powers. Nitrogen filled. Water and dust resistant. Windage and elevation with positive click stops.

### Wider Field — 55 Ft.

Wider field of 55 to 29 feet. Built in parallax adjustment. Change power **FAST** — with a flick of your finger. Sturdy scope caps included. **United Scope Mount \$9.99 — See page 38.**

Model #WGCR

**\$57.50**

## 4X GOLDEN PIONEER

Scope and Mount  
Weigh Only  
7 ozs.

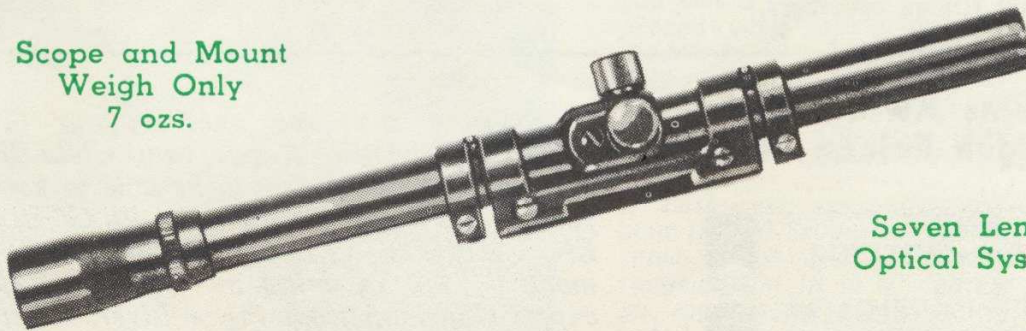

Seven Lense  
Optical System

Fast, easy installation. Comes complete with mount for use on .22 rimfire rifles with top dovetail groove receivers.

Coated. Achromatic lense system. Internal windage and elevation adjustments. Cross hair reticle. Tube is of steel and is ¾ inch. Length is 11¾ inches. Eyepiece — 20 mm. Field at 100 yards is 27 feet. **The scope and mount weigh only 7¾ ounces!** Sharp, crisp viewing. Carries United trademark as do all United optics. Quality is excellent for has a 7 lense achromatic optical system.

**\$18.95**



# United SCOPE MOUNTS

SPLIT-RING

2-PIECE

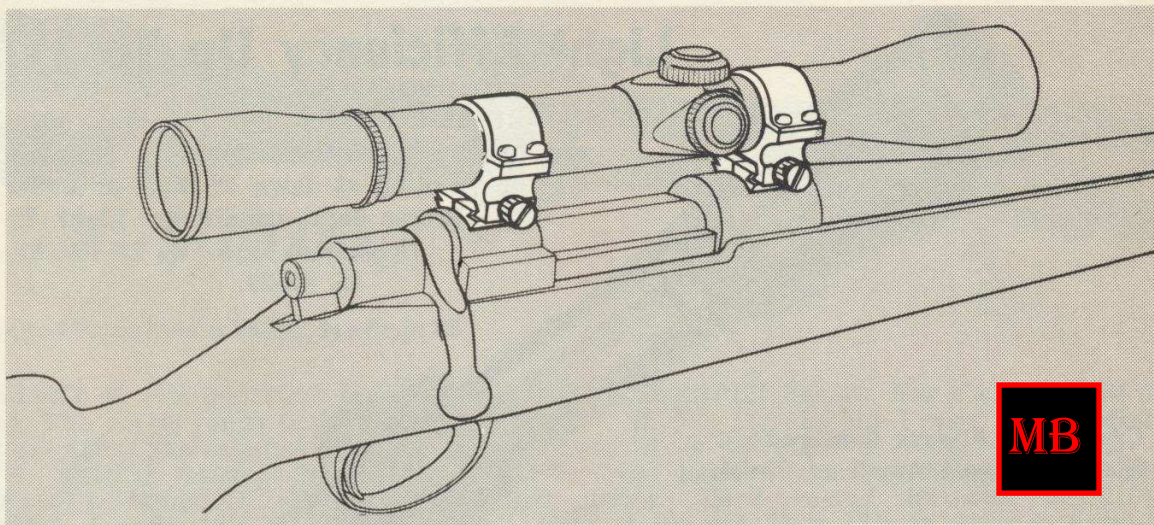

..... FOR 1 INCH TUBES . . . \$9.99

## FINE UNITED QUALITY

As with all United Optics, **United Scope Rings** carry the famous United "Seal Of Quality" trademark, your assurance of fine quality merchandise, popularly priced.

These low, streamlined, compact featherweight mounts fit all rifles and scopes including service rifles and assure absolute rigidity of your mounted riflescope.

Any riflescope mounted with **United Split-Ring Mounts** make any and all type of shooting more accurate. United "Seal Of Quality" Rings made in Japan and bases in the U.S.A.

### EASY TO MOUNT — ALL YOU NEED IS A SCREWDRIVER!

All bases clearly marked for front and rear placement. **STATE MAKE, CALIBER AND MODEL NUMBER OF RIFLE WHEN ORDERING!** Can also accommodate .22 rifles with grooved ribbed receivers.

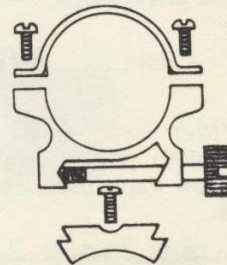

## Wins Award with Golden Falcon Scope



*"Please rush me one of your 6X GOLDEN HAWK Scopes with UNITED MOUNTS. I don't seem to be able to keep your scopes in stock. This is the 4th GOLDEN HAWK I have ordered in the last month." . . . So writes Mr. Athol Shields expert Gunsmith from Priest River, Idaho.*

*Mr. Shields writes further "I believe the best booster of scope sales is the fact I use UNITED SCOPES on my own personal rifles. The rifle in the picture is a .222 Remington, heavy barrellled, Sako Action, self stocked in maple. This super accurate varmint rifle is equipped with a United GOLDEN FALCON scope."*



# 20x80

## Observation Binocular



Created for those who want to SEE MORE!

20 POWER brings views 20 times closer. What appears as blurred to the naked eye now becomes a CLEAR sight picture.

80MM FRONT LENSE are rare in binoculars because they are costly to manufacture. In our United 20x80 we insist on these BIG 80MM FRONT lens for they permit more light to reach your eyes and your viewing will be sharper and brighter. 80MM means they measure about 3¼" across.

### BRINGS ALL VIEWS RIGHT IN FRONT

Is weather resistant so you can move your 20x80 to your porch, patio or yard area for out-of-door viewing. You can observe everything because it swivels right to left and up and down to catch ANYTHING you want to see. Set screws permit you to hold exactly on any sight picture to which you might want to return. You have COMPLETE CONTROL of ALL viewing area within your range of vision. Has rubber eye cups (which are easily removed) so oculars fit snugly around your eyes. This eliminates distracting light—it's like being in a "dark room". Has excellent field of 184 ft., from left to right. Optics are fully Coated for crisper images. Weighs about 39¼ lbs., and is 14 inches high. The binocular itself is 11 inches wide and 14 inches long. To assure safe delivery we ship by Railway Express transportation collect. C.O.D.'s require 25% deposit. Use 30 days, if not pleased return for refund.

# \$498.

### We Took Deer Of TROPHY Consideration —



Jim Sturgeon Admires "GOLDEN FALCON"

Gunmaker J. L. "JIM" STURGEON, well known gun expert in CALIFORNIA writes:

"The last scope I ordered from you was a "Golden Falcon" and it proved very satisfactory. It was mounted on a \$300.00 caliber .30 Gibbs and the customer was well pleased. Send me a 4x32 "Golden Hawk," 3-7X "Golden Eagle" and your 3-12X "Golden Plainsman."

"Last week our party used 3 of your United Scopes in the rain and snow for 3 days. Temperatures ranged from 18 to 50 degrees and no fogging or condensation was noted. Two (competitors name deleted) riflescopes were fogged so badly by the second day that they were put out of service. We took 5 Mule Deer, two of trophy consideration . . ."



# UNITED BINOCULAR CO.

UNITED BUILDING 9043 SO. WESTERN AVE. CHICAGO 20, ILLINOIS





**MB**

# United's Finest . . .

For spectacular viewing. Brings distant objects close-up!  
These models deliver ultra-high 20 and 30 power magnification and will bring images 20 and 30 times closer with crisp clarity. Precision built. Fully coated optical system. Combines the magnification of high powered telescopes WITH the depth and field of view of a prismatic binocular for outstanding performance. Popular center focus with individual focussing right eye piece — it's fast!

## 20 x 70

## 30 x 70

Front lenses are 70mm which are about 3 inches across permitting MORE light to come thru the optical system to give you sharp, clear image pictures. Bring objects 20 times closer! Excellent field of 183 ft. at 1000 yards. Weighs 52-oz., comes complete with handsome black leather carrying case and straps.

Thirty Power — brings all objects 30 times closer to you. Large 70mm front lenses are 3 inches across to permit more light to enter resulting in clearer sight pictures. Gives SHARP edge-to-edge image. Field is a good 105 ft. at 1000 yards. Weighs 56-oz. Complete with rich, black leather carrying case and straps.

### \$250

### \$300



**UNITED BINOCULAR CO.** UNITED BUILDING 9043 SO. WESTERN AVE CHICAGO, ILLINOIS 60620