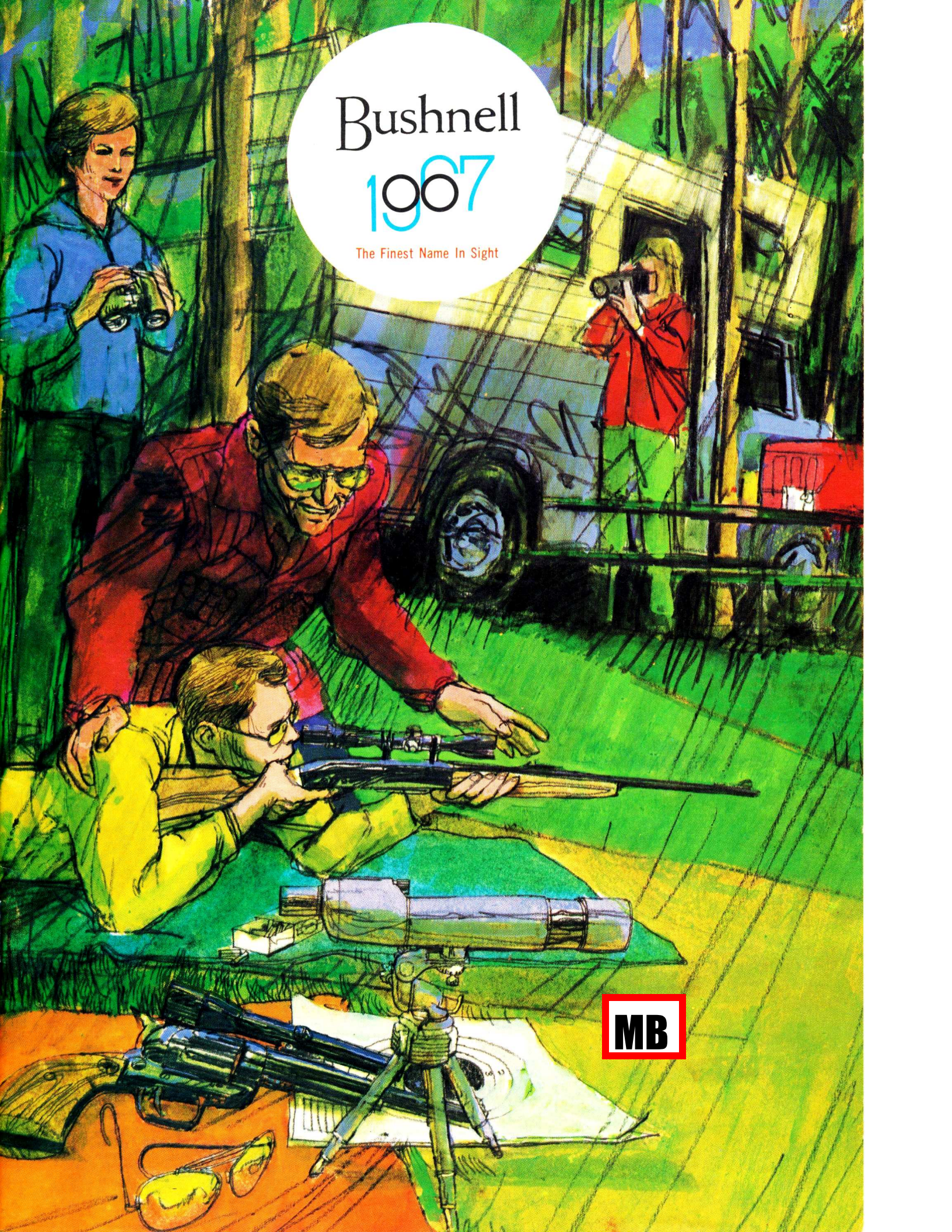


Bushnell

1007

The Finest Name In Sight



**MB**



## A Word About Bushnell

It's been many years since we introduced our first sport optics. Since then we've grown tremendously, yet we still get the same thrill in presenting you with new items (and, wait just as anxiously for your approval!). A lot of hard work has gone into these products . . . many prompted by your suggestions. We're excited about them and think you will be, too. Let us hear from you . . . we always welcome your letters.

*Dave Bushnell*

### FREE SERVICE WARRANTY — 30-DAY MONEY-BACK GUARANTEE

(1) All Bushnell optical products are high precision instruments of rugged construction. Each is fully tested and carries a free service warranty from Bushnell Optical Laboratory, Inc. (2) Bushnell instruments are warranted against defective materials and/or workmanship. Before shipping, each receives and must fully pass a series of tests covering essentials of optical and mechanical perfection. (3) The original Registered owner of a Bushnell instrument is entitled to free repair, free service, and free parts or replacement without charge for 20 years (unless otherwise stated), provided instrument in our opinion shows no visible signs of having been dropped, maltreated, or disassembled. (4) If the instrument does not answer your purpose and is returned to the authorized seller in its original condition within 30 days after purchase, your money will be immediately refunded in full by the seller. (5) Should you require service, please pack your Bushnell Instrument securely and enclose your report of unsatisfactory condition with your warranty card, stating when and from whom it was purchased. Mail it to us prepaid and insured. If you request it, an estimate of any charges will be sent you before work is done. Your instrument will be returned to you prepaid.



#### BUSHNELL OPTICAL LABORATORY, INC.

2828 East Foothill Blvd., Pasadena, California 91107  
In Canada: 1310 West Sixth Avenue, Vancouver 9, B.C.



Bushnell optical instruments are designed and tested for practicability and excellence by Bushnell optical and mechanical engineers, in collaboration with actual users in the field. For maximum economy, they are produced in Japan in factories selected for their uncompromising tradition of craftsmanship and pride in workmanship. Then, back in Bushnell laboratories, they are rigidly tested optically . . . mechanically . . . functionally. Only those instruments which measure up to the initial high standards are granted the Bushnell trademark.

Bushnell binoculars are rated tops in consumer buying guides, were chosen for use by Armed Forces in Viet Nam, selected by NASA Scientists for use in Gemini spacecraft and are first choice of such noted professionals as:



"Bushnell Binoculars give me the vision necessary to keep on top of the play or race . . . Bushnell's are truly the All-Americans of the binocular field."  
**Tom Harmon, Sports Director, ABC**



"Your Spacemaster and other photo optic units are the most effective I've ever used with or without a camera. Pictures taken through these instruments astonish me."  
**Erle Stanley Gardner, World Famous Author**



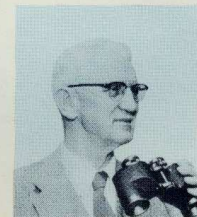
" . . . we had not the slightest difficulty even in Rain Forest with condensation or moisture of any kind accumulating inside the instruments . . . the finest optical equipment that any expedition has ever had."  
**R. Marlin Perkins, Director, St. Louis Zoological Gardens**



" . . . with a single shot blasted a bull moose . . . first time I ever hunted big game with a handgun . . . luck coupled with Bushnell ingenuity . . . that Phantom Scope!"  
**Wally Taber, International Hunter and Lecturer**



"Good binoculars are an important aid to flying. Your Rangemasters are perfect. Plenty of magnification, wider field of view, and a most brilliant image."  
**Donald W. Douglas, Sr., Douglas Aircraft Corporation**



"Have referred a good many inquiries to Bushnell because I like their optical quality, attractive finish, moderate prices. When I purchased a glass, I chose Bushnell over all others."  
**Dr. Dinsmore Alter, Former Director, Griffith Observatory, Author, Lecturer, Scientist**

## LOOK HERE...



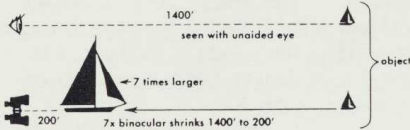
## Let's take the mystery out of binoculars

A fine binocular is a lifetime investment, one which pays you ceaseless dividends in enjoyment; asks nothing in return except the same care you give your other fine instruments. Selecting the binocular most suited to your needs is not a tricky "numbers game." The numbers are nothing more than a simple, practical guide to help you select binoculars more quickly and confidently. Our business is binoculars, so let us help you take the mystery out of them right now!

### DECODING . . . BY THE NUMBERS

Ever since Mr. Galileo made up the rules, the number preceding "x" (as in 7x, 35mm) has stood for **power of magnification** . . . meaning the binocular will bring an object that **many times closer** to the viewer; or make it appear that **many times larger** than it appears to the naked eye. Either definition is correct.

The number following "x" (such as 30, 35, 50, etc.) is simply the **diameter** of the front (objective) lens expressed in **millimeters**. This diameter is a factor in **light transmission** . . . a subject which is fully covered in the section titled, "Some Light Calculations."



### DON'T BE 'OVERPOWERED'

As magnification increases, hand tremor becomes more noticeable . . . steady viewing more difficult. In fact, the most significant reason behind the all-time popularity of 7x, 35mm models is that a **7 power glass offers the ideal magnification an average viewer can use without undue disturbance**. 6, 8 and 9 power binoculars are also considered standard, but above 9, prolonged viewing often requires something more substantial than hand-held support.

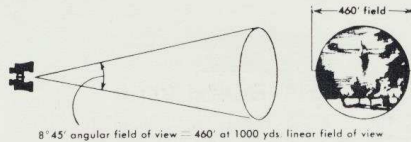
You can easily determine your most comfortable viewing, by looking at a detailed object through several different models. Be sure to allow for the effect of fatigue by holding each glass on target for two or three minutes.

### CONFUSED ABOUT FIELD OF VIEW —

Well, don't feel badly . . . it's one of those things that have been complicated out of proportion by well-meaning, if somewhat overzealous 'experts.'

Field of view is simply the diameter (width) of the picture seen at any given distance . . . it varies tremendously among binocular brands and models, and is usually expressed two ways —

Look for a figure on the binocular showing degrees and minutes; such as, 8° 45'. This is **angular field**. Field of view, in turn, is expressed in an absolute figure, such as 460 feet. This means you see a picture of 460 feet diameter at 1000 yards . . . 1000 yards being a standard comparative distance.



All else being equal, the widest field possible consistent with optical quality is highly desirable . . . especially for hunters and sports spectators.

### LOOK SHARP . . . YOU CAN SEE THE DIFFERENCE



In binocular optics, like camera optics, the capacity to retain detail and clarity is called **RESOLUTION** . . . or **DEFINITION**. Take two 7 power glasses, widely varied in price. Unless there's false labeling involved, both will bring an object **seven times closer** . . . but the difference in distinguishing fine detail can be shocking! You can see the difference yourself, by trying to read a magazine with a so-called bargain binocular from the maximum distance you can read the same page with a better brand.

And while we're on this subject, there's the matter of prolonged viewing. Better binoculars are built with your eyes in mind . . . they're critically sharp and optically balanced to deliver eye-saving comfort hour after hour. The person who says after a short look, "I can see all right with this lower priced binocular," runs the risk of experiencing some degree of eyestrain every time he puts them to **extended use**.

Remember, **SUPERIOR OPTICS** are one of the main ingredients of high quality binoculars!

### SOME LIGHT CALCULATIONS

A binocular's capacity to transmit light is dependent on three factors:  
1. Optical quality 2. Coating  
3. Size of exit pupil

### Optical Quality

The importance of this factor is simply that the **BEST** optics deliver the **HIGHEST** resolution and eye-saving comfort . . . **SUPERIOR** optics are the main ingredient of high quality binoculars . . . and deliver the best picture . . . from every **viewpoint!**



### Coating

Most modern binoculars have some hard-coating; although often not enough. The purpose of hard-coating is to **reduce reflection**, and for best results it must be applied on **all** optical surfaces. A simple test of this is to catch the reflections of a white fluorescent tube in the objective end of the binocular, and again in the eyepiece. On both ends, you will see a reflected image of the tube from **each** external and internal optical surface. On a 100% coated binocular, **all** images will be either **blue** or **amber** (either is acceptable) . . . otherwise, every **white** image will represent an **UNCOATED** surface.

100% coating is standard procedure in the crafting of better binoculars.

### Exit Pupil

While you're looking, notice the bright disc of light emitted from the eyepieces. This is the exit pupil which transmits light to the eye. Its diameter is determined by **dividing the magnification of a binocular into its objective lens diameter**



(for example, a 7x, 35mm binocular produces a **5mm** exit pupil). For normal use, including **occasional** night viewing,

a 3.75mm (8x, 30mm = 3.75mm) or larger exit pupil will be sufficient. If night viewing is your dominant use, the 7x, 50 mm binocular offers a huge 7.1mm exit pupil, which corresponds to the widest opening of the human eye.

### BETTER BINOCULARS COST LESS TO OWN . . .

Because you pay for them only once!

Any top-notch binocular will take hard knocks in stride . . . we mean the normal, day-to-day punishment that a less ruggedly constructed glass might not endure. The owner of a "bargain" binocular can easily spend many times its original value in repairs . . . and he'll still end up with something much less than the best.

### LIFETIME INVESTMENT

Think twice when you say to yourself, "I only use binoculars occasionally." 'Occasionally' adds up to hundreds, or even thousands of hours over a lifetime. With that much service in sight it pays you to take the time to select a binocular that will let you look forward to sparkling, comfortable vision that's built-in to **stay** . . . and do business with a company whose service is as dependable as its products.

### MORE THAN MEETS THE EYE

Even though you can actually **see** the big difference among binoculars, there's much more than meets the eye. For instance —

- Weight and handling comfort
- Construction detail
- Design specifications
- Precision of moving parts
- Carrying Case quality
- Guarantee policy



We think Bushnell's advertised 30-Day Trial-Exchange Privilege is an ironclad case in point. (Read the famous Bushnell Warranty thoroughly.)

Comparisons like this make a fine binocular look even better!

# New Bushnell Featherlight II

- Exclusive mono-unit, magnesium alloy body for maximum strength and durability, minimum weight.
- Unexcelled brilliance. Special amber hard coating on all optics for superior light efficiency.
- All optics selected, polished and aligned to super critical standards.
- Widest field, Safety Vision optical system formulated by electronic computers.
- Shock proof construction; permanently locked high index prisms.
- Exclusive no glare Ultra Violet filters.
- Fast, accurate center focus and individual right eye adjustment.
- Built-in tripod socket.
- 20-year warranty.

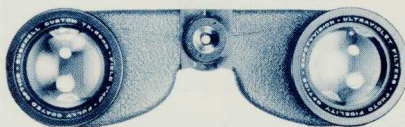


## ALL PURPOSE 7x35 FEATHERLIGHT II

By far the world's most popular choice for hunting, sports, sightseeing... all around viewing... your first look through these new 7x35's will instantly reveal the crystal-clear difference between these and other brands. Ultraviolet filters protect against glare from snow, sand and water. Field at 1000 yds.: 404'. Exit Pupil: 5mm. Height: 5½". Weight: 28 oz. Shipping Weight: 3 lbs. 3 oz.

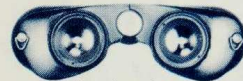
#11-7352 CF only \$84.50

Exclusive **ULTRA VIOLET FILTERS** for maximum eye protection and comfort against glare from water, snow and sand.

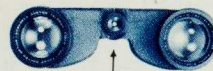


The new mono-unit design of the Featherlight II Binocular line is the most magnificent and functional improvement in binoculars in 30 years. Your first breathtaking look will reveal the big crystal-clear difference between these and ordinary binoculars. You even feel the difference as the sculptured curve of the body design balances effortlessly in your hands... in its satin-smooth adjustments... its flawless detail. High index prisms and full 36mm objectives in 6x, 8x and 9x give you brighter, sharper viewing than ever before. This is quality you can depend on... accurate, brilliant performance. Like the finest watch, the Featherlight II is constructed for "keeps," asking only reasonable care in exchange for a lifetime of trouble-free service.

No engraving on top plate to distract eyes.



Carrying strap attaches on top binocular always hangs straight. Distinctively engraved around lenses like fine cameras.



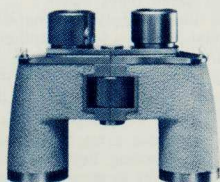
Socket for tripod adapter



Tripod Adapter, \$3.95



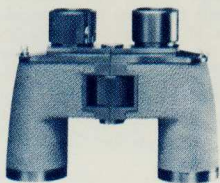
Every binocular comes complete with our luxurious, hand-crafted case and straps, an exclusive design that lets you remove binocular right side up, ready for use.



## 8 x 36 FEATHERLIGHT II

Excellent daylight and twilight performance for all around use when traveling, hunting, viewing sports or in nature study. Field at 1000 yds.: 404'. Exit Pupil: 4.5mm. Height: 5⅝". Weight: 27 oz. Shipping Weight: 3 lbs. 2 oz.

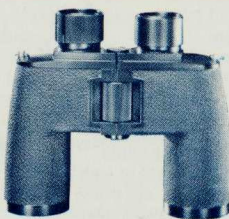
#11-8362 CF only \$89.50



## 9 x 36 FEATHERLIGHT II

Excellent for advanced bird watchers and those who hunt in mountain country. Highest power recommended for hand held use. Field at 1000 yds.: 404'. Exit Pupil: 4mm. Height: 5½". Weight: 28 oz. Shipping Weight: 3 lbs. 2 oz.

#11-9362 CF only \$92.50



## 10 x 50 FEATHERLIGHT II

High efficiency glass for day or at dusk. Ideal for hunters glassing at long distances, ornithology and other long distance viewing needs. Field at 1000 yds.: 368'. Exit Pupil: 5mm. Height: 6⅞". Weight: 40 oz. Shipping Weight: 4 lbs. 8 oz.

#11-1052 CF only \$110.00

### 7 x 35 WIDE ANGLE PANORAMIC RANGEMASTER

Unquestionably the finest wide-angle binocular. Selected for Armed Forces in Viet Nam, professional sportscasters, big game hunters, anyone who needs extra wide range and razor sharp definition. Ultra modern contour body provides perfect balance for prolonged viewing comfort, 90% more viewing area than standard 7 x 35's. Exceptional clarity and brilliance. Unsurpassed choice for sports, spotting game, travel. Field at 1000 yds.: 578'. Exit Pupil: 5mm. Height: 4¾". Weight: 38 oz.

#11-7392 CF only \$135.00

Shipping Weight: 4 lbs. 12 oz.



## For Night and Marine Viewing



Bright  
brilliant  
Bushnell  
Binoculars  
with  
extra large  
exit pupils



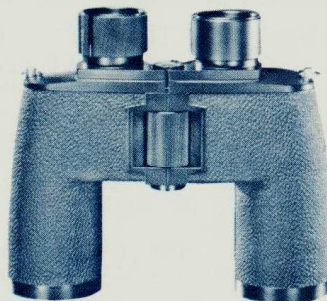
### 7 x 50 FEATHERLIGHT II

The extra high light transmission of this superior new 7x50 binocular makes it the outstanding choice for boat owners, night watchmen, and others who work under minimum light conditions . . . at night or in adverse weather. There's heft to these well balanced binoculars that men of action go for.

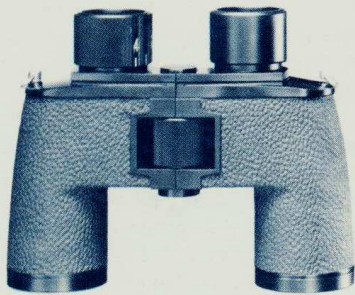
Field at 1000 yds.: 394'. Exit Pupil: 7.1mm. Height: 7⅛". Weight 40 oz.

#11-7502 CF only \$99.50

Shipping Weight: 4 lbs. 8 oz.



Regulation Marine Size - 7x50



New! For boat owners - 6x36

### 6x36 FEATHERLIGHT II

Now . . . Bushnell solves the problem: Easy-handling binoculars with exceptionally brilliant light gathering characteristics nearly 50% greater than conventional 6 or 7 power models. Lighter, more compact than 7x50's above . . . yet, the field of view is greater. Ideal for yachtsmen, boat owners — hikers, hunters, spectators, too or anyone who wants superior viewing under poor light conditions. Ultra-violet filters protect eyes against harmful glare of water, snow or sand.

Field at 1000 yds.: 404'. Exit Pupil: 6mm. Height: 5¾". Weight: 28 oz.

#11-6362 CF only \$79.50

Shipping Weight: 3 lbs. 3 oz.

**Custom  
Binoculars  
for  
eyeglass wearers**

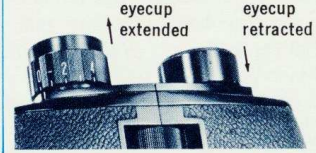
Top rated, award winning Custom Binoculars have achieved outstanding acclaim for the unique, special design of their optical system (not "just" retractable eyecups) that gives eyeglass and non-eyeglass wearers the same full, brilliant field of view.

- 20 Year Warranty



**AWARD WINNING  
BUSHNELL 7x35  
CUSTOM**

Features not only retractable eyecups but unique wide view optics for full broad field even when wearing eyeglasses or sunglasses. Also, exclusive no glare Ultra Violet Filters.



**WORLD FAMOUS 7x35 CUSTOM**

Top rated by customers, this superb all-purpose binocular has a unique optical system in combination with retractable eyecups that gives the same full field of view with or without sun or eyeglasses. Ultraviolet filters protect against glare from snow, sand and water. Exceptional optics provide clear, brilliant viewing. Ideal for travel, vacations, spectator sports, hunting, nature study.

Field at 1000 yds.: 404'. Exit Pupil: 5mm. Height: 5". Weight: 23 oz. Shipping weight: 3 lbs. 2 oz. #10-7351 CF only \$98.50



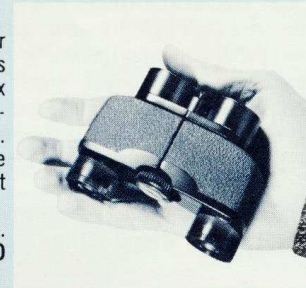
Slips easily in "his" shirt pocket for rugged hunting duty... or elegantly into "her" evening bag for theatre or opera.

**TINY 6x25 CUSTOM COMPACT — ONLY 3" HIGH**

This little 3" high binocular is light to carry, fits easily in shirt or jacket pocket ready for instant use. That's not all, the weight is only 11 ounces — less than half the weight of most other 6x binoculars. Through its unique optical system and extendible eyecups it gives a full field of view with or without eye or sunglasses. Designed for hunters, it is sturdy as a work mule, yet handsome enough to carry to the theater. Comes complete with a soft zippered carrying case.

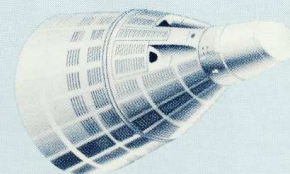
Field at 1000 yds.: 420'. Exit Pupil 4.22mm. Height: 3 1/8". Weight: 11 oz. #10-6251 CF only \$64.50

Shipping weight: 1 lb. 4 oz.



**CUSTOM COMPACT USED IN GEMINI SPACECRAFT**

Bushnell Custom Compact selected by NASA scientists for use in special secondary sighting system for Gemini spacecraft. The left half, modified for use with the sextant, received critical space flight qualification tests (high-low temperature, shock, vibration, atmosphere, humidity, etc.) and passed with better than required ratings. Secondary sighting system backs up inertial platform for angle measurement and radar for timing and measurement of range during rendezvous and docking with Agena rocket.



# Featherlight I

- Rugged, lightweight, one-piece aluminum body.
- Greatest brilliance. Special hard coating for superb light efficiency.
- All optics selected, polished and aligned to critical standards.
- Wide field, SafetyVision optical systems.
- Shock proof construction; permanently locked high index prisms.
- Fast, convenient center focusing and individual right eye adjustment.
- 20-year warranty.



A fine binocular is a lifetime investment, one which pays you ceaseless dividends in enjoyment. Your enjoyment of sports events, vacation trips, hunting, nature study will be greatly increased with the fine quality viewing you get with a Bushnell Featherlight Binocular. Each comes complete with carrying case and straps.



7x35

## Featherlight 7x35

Outstanding quality. An excellent all-around choice for hunting, spectator sports or bird-watching. Exceptional crisp, clear optics. Field of View: 404'. Exit Pupil: 5mm. Height: 5½". Weight: 23 oz.

#11-7351 **\$74.50**

Featherlight 7x35 Monocular  
#14-7350 **\$39.50**

## Featherlight 7x50

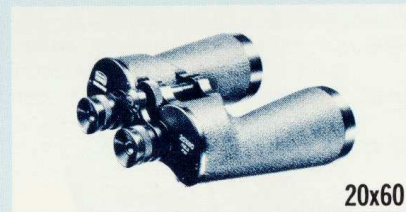
The extra high light transmission of this 7x50mm Featherlight binocular makes it an excellent choice for use as standard equipment for night watchmen, boat owners and others who work under minimum light conditions.

Field of View: 375'. Exit Pupil: 7.1mm. Height: 7". Weight: 41 oz.

#11-7501 **\$89.50**



7x50



20x60

## Featherlight 20x60

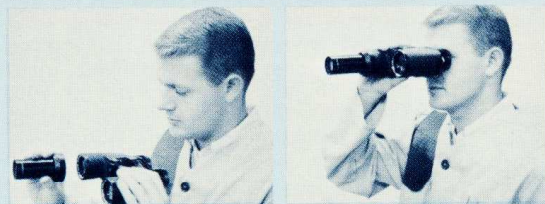
Extra high power and precision optics for distance viewing make this binocular especially popular for mountain cabins, ocean or lake view homes, star gazing.

Field of View: 184'. Exit Pupil: 3mm. Height: 9". Weight: 48 oz.

#11-2061 **\$155.00**

## Your Bushnell Binocular Converted in Seconds to a High Power Spotting Scope

The exclusive pocket size (4-ounce) Bushnell Binocular Spotter attaches quickly to your binocular. In seconds it increases the power of your binocular 2½ times (6x becomes 15x, 7x becomes 17.5x, etc). The combination is an ideal spotting scope for hunters, shooters, hikers, bird-watchers, to capture details from 40 feet away . . . and beyond . . . in exciting detail never possible with binoculars alone. Capture vacation sights in new perspective, without carrying a bulky telescope. Produced in Japan to Bushnell's highest optical standards, the new spotter, including belt loop carrying case, is **only \$19.95**.



SPECIFICATIONS	
Spotter Power, 2.5x	
Lens Diameter, 32mm.	
Height, 4" / Weight, 4 oz.	
Binocular Power	With Spotter
6x	15x
7x	17.5x
8x	20x
9x	22.5x

(1.) Easy to attach. Just press the Spotter over the right objective (front) lens of the binocular. With fingers tighten nylon set screw on collar of Spotter to secure it to the binocular. Instantly, it is ready for rugged field duty.

(2) To view just shut your left eye (or leave lens cap on) and sight as you would through a spotting scope or telescope. (You cannot look through both sides of binocular when spotter is attached or use Spotters over both objective lenses at same time as sighting alignment would not be maintained.)

### Bushnell Binocular Spotter, \$19.95

Price includes Spotter carrying case with belt loop.

#16-0001 for 6x36, 7x35, 8x36, 9x36 Featherlight II, 7x35 Custom or other binoculars with 2.09" objective end ring outer diameter).

#16-0002 For 7x35 Banner or other binoculars with 1.97" objective end ring (outer diameter).

#16-0003 for 6x30, 8x30 Sportview or other binoculars with 1.57" objective end ring (outer diameter).

#16-0004 for 7x35 Sportview or other binocular with 1.84" objective ring.

### Tripod Adapters for Binoculars

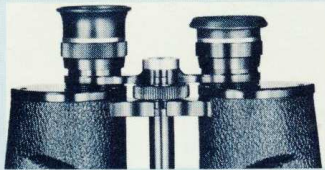
#16-1000	Tripod Adapter (Custom and Featherlight II Binoculars)	\$ 3.95
#16-1100	Tripod Adapter for open center post binoculars	\$ 3.95
#16-2000	Binocular Adapter for 35mm reflex and 8-16mm movie cameras	\$14.95
#16-2100	Binocular Adapter for twin lens camera	\$14.95

# Bushnell Ultra Vision Binoculars

- Two lightweight aluminum body styles: traditional two-piece, and extra rugged one-piece.
- Ultra-violet filters for glare-free viewing built in.
- Brilliant, hard-coated optics.
- Fast, convenient center focusing and individual right eye adjustment.



**Ultra-Violet Filters** protect against harmful glare from snow, sand, water. Note distinctive deep blue objective lenses.



**Adjustable Rubber Eyecups** roll down for wide field while wearing glasses. Left up, they cut out distracting side light.



Deluxe Top-Opening Case.

Sportsgoer, hunter, hiker, nature lover: Here are deluxe binoculars designed to meet every need of the outdoor man and woman . . . and produced with the concern for quality on which Bushnell has built its reputation. The hard-coated, distortion-free optical system of each Ultra Vision binocular registers a bright, clear viewing picture. Every binocular comes complete with a luxurious handcrafted case and straps.



7x35

**Ultra Vision 7x35 Extra Rugged**  
**ALL PURPOSE**, same general uses as above. Wider field provides greater viewing area. Sturdier one-piece body allows for extra rugged duty. Ultra violet filters, tripod socket. 5 year warranty. Field at 1000 yds.: 385'. Exit Pupil: 5mm. Height: 5 1/4". Weight 21 oz.  
#12-9110 **\$59.95**

## Ultra Vision 7x35

**ALL PURPOSE**, the popular favorite. The 7x35's versatility makes it ideal for sports, vacations, hunting, hiking, bird-watching — all outdoor activities. Two-piece body, ultra violet filters, tripod socket. 1 year warranty. Field at 1000 yds.: 345'. Exit Pupil: 5mm. Height: 5 5/8". Weight: 22 oz.  
#13-9116 **\$49.95**



7x35



7x35 Wide Angle

## Ultra Vision 7x35 Wide Angle

**WIDER FIELD OF VIEW** lets you cover big chunks of territory fast and accurately with more than twice the viewing area of standard 7x35's. Unmatched for races, fast-action sports events, spotting game. Sturdy one-piece body, ultra violet filters, tripod socket. Roll-down eyecups not required. 1 year warranty. Field at 1000 yds.: 578'. Exit Pupil: 5 mm. Height: 4 1/2". Weight: 32 oz.  
#13-9117 **\$66.95**

## Ultra Vision 7x50

**NIGHT AND MARINE.** Highest light gathering power of all Ultra Vision binoculars. 50mm objective lenses make this the best selection for bright, clear viewing when boating, at night, or in adverse weather. Two-piece body, ultra violet filters, tripod socket. 1 year warranty. Field at 1000 yds.: 380'. Exit Pupil: 7.1mm. Height: 6 7/8". Weight: 36 oz.  
#13-9118 **\$58.95**



7x50



7x50

## Ultra Vision 7x50 Extra Rugged

**NIGHT AND MARINE.** Highest light gathering power for same uses as above. Finer quality, superior optical system, sturdier one-piece body provide greater durability for extra rugged performance. Ultra violet filters, tripod socket. 5 year warranty. Field at 1000 yds.: 380'. Exit Pupil: 7.1 mm. Height: 7 1/8". Weight: 36 oz.  
#12-9112 **\$75.50**

## Ultra Vision 10x50

**HIGH POWER.** For extra long range viewing, here is a binocular that will give you sharp, bright detail, even under adverse lighting conditions. Ultra violet filters. tripod socket. 1 year warranty. Field at 1000 yds.: 310'. Exit Pupil: 5mm. Height: 7". Weight: 36 oz.  
#13-9119 **\$61.95**



10x50



# Bushnell Banner Binoculars

- Rugged one-piece body of lightweight aluminum
- Fully hard-coated, distortion free optics for clear, brilliant viewing.
- Wider field, precision optical system.
- Solid construction, prisms locked in position.
- Fast, convenient center focusing, individual right eye adjustment.
- 5-year warranty.



From start to finish, the Banner has been crafted with the heft, precision and inner quality you naturally expect in a Bushnell instrument. The hard-coated, distortion-free elements that make up its optical system register a bright, clear picture that beats anything you've ever seen for the price. The Banner is solidly constructed from rugged, lightweight aluminum, molded into a proven design. Its built-in toughness is cleanly reflected in the firm smoothness of its moving parts, and the flawless, durable quality of its exterior finish.

A handsome carrying case, handcrafted in America, with zipper closing and straps, is included with each Banner binocular.



7x35

## Banner 7x35

All-purpose 7x35's have long been the overwhelming choice of hunters, sportsmen, experts in many fields. Perfect, too, for anyone who enjoys a variety of viewing pleasures. With its compact size, 7 power Bushnell 7x35mm Banner is ideally suited to those who want an accurate, dependable all-purpose binocular.

Field of View: 378'. Exit Pupil: 5mm. Height: 5 1/4". Weight: 22 oz.

#12-7350

\$49.95

## Banner 6x30

Lightweight and compact, the 6x30mm is just the ticket for steady, prolonged viewing. 6 times magnification and generous field of view make it a favorite among hunters and sports spectators who must follow fast action at medium range.

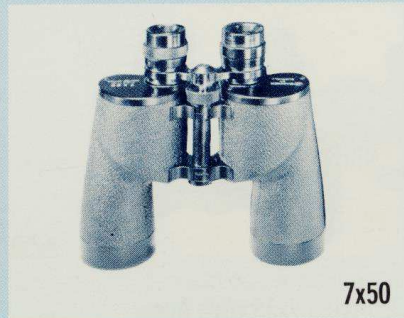
Field of View: 394'. Exit Pupil: 5mm. Height: 4 7/8". Weight: 21 oz.

#12-6300

\$47.50



6x30



7x50

## Banner 7x50

For night viewing and marine use the 7x50mm's large objective lenses deliver extra light when it's needed most... at night, in adverse weather. Long standing favorite of military and mariners, the perfect glass for boat owners, night watchmen, etc.

Field of View: 375'. Exit Pupil: 7.1mm. Height: 7-1/16". Weight: 36 oz.

#12-7500

\$63.50

## Banner 7x35 Wide-Angle

First introduced by Bushnell, the wide-angle 7x35 has become standard equipment for sportscasters and others who must cover big chunks of territory fast and accurately. Like its world-famous counterpart, the Rangemaster from Bushnell's top line, the Banner actually delivers 90% more area of sight than ordinary 7x35's. For big, bright, crystal-clear viewing, nothing in its price range can touch the wide-angle Banner.

Field of View: 578'. Exit Pupil: 5mm. Height: 5". Weight: 32 oz.

#12-7390

\$79.95



7x35 Wide-Angle



7x through 12x ZOOM

## Banner 7x through 12x ZOOM

Zoom in on sports action from all-purpose 7 power through every power right up to 12-power without changing focus. There's no visual distortion as you pinpoint the action of a touchdown pass or a finish line. Perfect for hunting and nature study, too. Find your game at 7x, then zoom in to study it at 12x. Light weight, scarcely more than standard 7x35's. Tripod socket built-in.

Field of View: 328-300'. Exit Pupil @ 7x: 5mm. Height: 6 1/2". Weight: 27 oz.

#12-7120

\$84.50

# Bushnell Sportview Binoculars

- Traditional body of light weight aluminum.
- Brilliant, fully coated optics.
- Wide field viewing.
- Fast, convenient center focusing and individual right eye adjustment.
- 1-year warranty.



With the introduction of Bushnell's new low price Sportview Binoculars, even the occasional user or family on a limited budget can own a good, clear, dependable binocular . . . one you are proud to own or give as a gift.

A handsome carrying case is included with each Sportview binocular.



7x35

### Sportview 7x35

Good choice for all-purpose viewing for every situation: hunting, sports events, nature study, vacationing.

Field of View: 341'. Exit Pupil: 5mm. Height: 5 $\frac{3}{8}$ ". Weight: 22 oz.

#13-7350

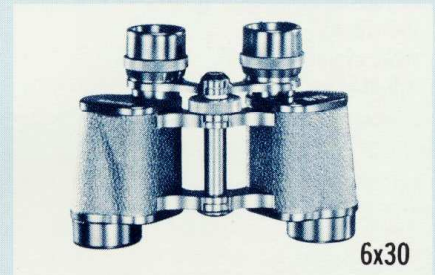
\$39.95

### Sportview 6x30

Good choice for all-purpose viewing at medium range. Full field, bright and clear for spectator sports and following fast action. Field of View: 394'. Exit Pupil: 5mm. Height: 4 $\frac{5}{8}$ ". Weight: 18 oz.

#13-6300

\$34.95



6x30



8x30

### Sportview 8x30

Excellent, lightweight binocular for fast action and general observation at longer distances for hunting or outdoor sports. Field of View: 394'. Exit Pupil: 3.8mm. Height: 4 $\frac{1}{2}$ ". Weight: 18 oz.

#13-8300

\$37.95

### Sportview 7x35 Wide Angle

Extra-wide field, very good for sports events, spotting game, following fast action. Wide-angle binoculars are all-around favorites for their larger viewing area.

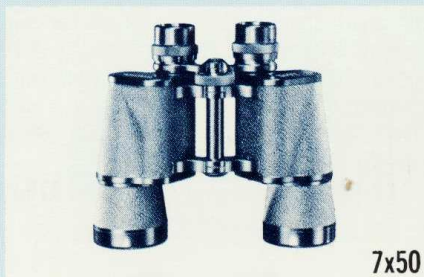
Field of View: 578'. Exit Pupil: 5mm. Height: 4 $\frac{1}{2}$ ". Weight: 30 oz.

#13-7390

\$54.95



7x35 Wide Angle



7x50

### Sportview 7x50

High light gathering power, very good selection for boating, at night, or in adverse weather. Images are bright and clear through higher light gathering power of 50mm objectives.

Field of View: 376'. Exit Pupil: 7.1mm. Height: 6 $\frac{7}{8}$ ". Weight: 36 oz.

#13-7500

\$46.95

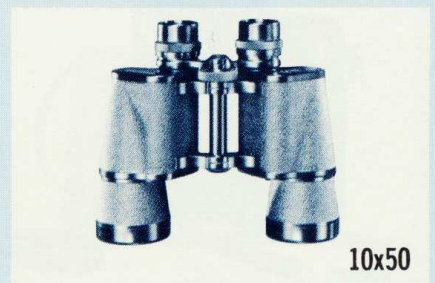


### Sportview 10x50

For extra long range viewing here is a binocular that will give you sharp, bright detail, even under adverse lighting conditions. Field of view: 268'. Exit Pupil: 5mm. Height: 7". Weight: 36 oz.

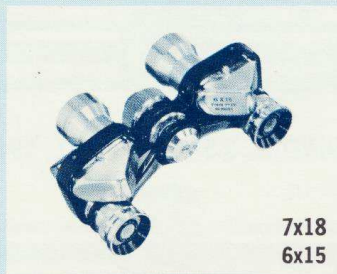
#13-1050

\$49.95



10x50

# Bushnell Opera and Sports Glasses



7x18  
6x15

### 6x15 PALM POCKET (left)

Full six power magnification in an incredibly small, lightweight glass. Doubles power of conventional opera glasses, offers fast, fine central focusing. Excellent for spectator sports, theatre, yet built to withstand roughest outdoor use. With handsome brown cowhide case.

#15-6150 **\$24.50**  
Field of View @ 1000 yards: 380'. Exit Pupil: 2.5mm. Height: 2". Weight: 8 oz. Shipping Weight: 1 lb. 1 oz.

### 7x18 PALM POCKET (far left)

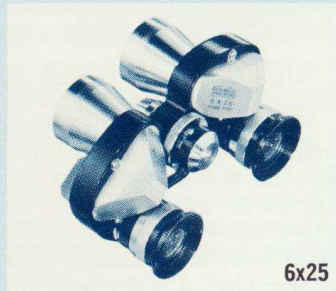
The most popular magnification for general use in a small, lightweight, easy-to-carry size. A favorite of the outdoorsman who wants a glass he can slip in and out of his pocket while exploring, hiking, camping, traveling, and at spectator sports. Quick center focusing. With handsome brown cowhide case.

#15-7180 **\$29.50**  
Field of View: 325'. Exit Pupil: 2.6mm. Height: 2 3/8". Weight: 8 oz. Shipping Weight: 1 lb. 2 oz.

### 6x25 BROADFIELD (right)

Extra-wide field in a small, rugged binocular — specifically designed for hunters who want a large viewing area for following moving game and constructed to take rough, outdoor use. Also excellent for sports events, racing, vacationing, theatre. Slips in jacket pocket. Fast center focusing, chrome finish. With handsome black case.

#15-6250 **\$52.50**  
Field of View: 577'. Exit Pupil: 4.2mm. Height: 2 1/2". Weight: 16 oz. Shipping Weight: 1 lb. 6 oz.

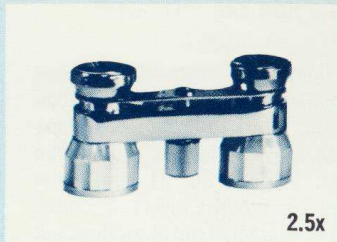


6x25

### 3x30 SPORTS GLASS (below)

Extra-wide field (525 feet) gives greater viewing area, makes fast sports action easier to follow. Ideal for viewing in or out of doors. Sturdy construction, non-adjustable eye-width.

#15-3300 **\$19.50**  
Height: 2 1/4". Weight: 8 oz. Shipping Weight: 1 lb. 2 oz.

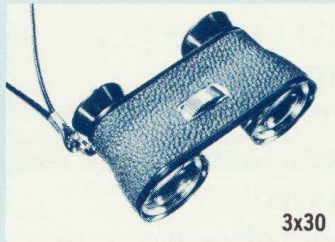


2.5x

### 2.5x OPERA GLASS (left)

Exquisite mother-of-pearl combined with sparkling chrome makes a high fashion opera glass, beautiful to look through and look at. With elegant silk brocade case.

#15-2500 **\$19.50**  
Height: 1 3/4". Weight: 7 oz. Shipping Weight: 12 oz.



3x30

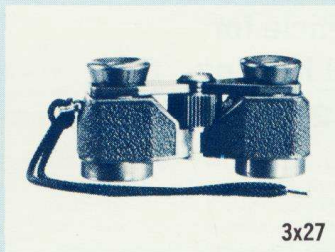
### 3x28 OPERA GLASS (right)

Stylish opera glass has gleaming black lacquer finish with lustrous mother-of-pearl accents. With handsome black case.

#15-3280 **\$19.50**  
Height: 2 1/4". Weight: 7 oz. Shipping Weight: 1 lb. 2 oz.



3x28



3x27



4x30

### 4x30 FIELD GLASS (left)

Looks like an opera, performs like a field glass. Ruggedly constructed for rough outdoor use: camping, hiking, boating, traveling. Small enough to fit in jacket pocket. Handsome black finish. With brown side-opening cowhide case.

#15-4300 **\$14.50**  
Height: 2 3/4". Weight: 7 oz. Shipping Weight: 1 lb. 2 oz.

### 3x27 OPERA GLASS (above)

Compact, ruggedly built gray opera and sports glass that dresses to meet any occasion. The perfect, versatile glass for the entire family.

#15-3270 **\$19.50**  
Height: 1 7/8". Weight: 6 oz. Shipping Weight: 1 lb. 2 oz.

## Binocular Rating Chart

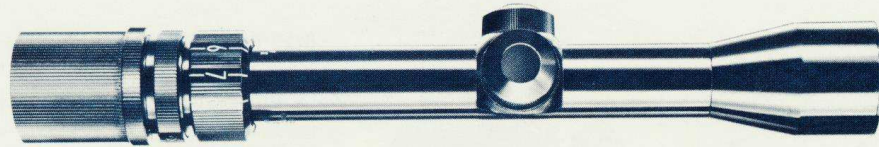
Key: (EX) Excellent (VG) Very Good (G) Good (F) Fair (NR) Not Recommended

Leading Uses	6x15	Broad-field 6x25	Custom 6x25**	6x30	6x36*	7x35*	Range-master 7x35	Custom* 7x35**	7x50*	8x30	8x36*	9x36*	10x50*	20x60	Zoom
General Use	G	VG	VG	VG	EX	EX	EX	EX	G	VG	VG	G	G	NR	G
Wooded Area	NR	VG	VG	EX	EX	EX	EX	EX	F	VG	G	G	G	NR	G
Semi-Wooded	F	G	VG	VG	VG	EX	EX	EX	VG	VG	G	G	G	NR	F
Open Flats	G	G	VG	G	G	VG	EX	EX	G	EX	EX	EX	EX	G	EX
Wild Fowl	G	VG	VG	VG	VG	EX	EX	EX	VG	G	G	G	F	NR	VG
Races—Sports	G	EX	VG	EX	EX	VG	EX	EX	VG	G	G	G	G	NR	G
Distant View	F	F	F	F	F	G	G	G	G	VG	VG	EX	EX	EX	EX
Nature Study	G	VG	VG	EX	EX	EX	EX	EX	VG	G	VG	G	F	NR	G
Marine	NR	F	F	F	G	VG	EX	EX	EX	F	G	F	G	NR	F
Night Use	NR	F	F	G	VG	G	VG	G	EX	F	F	F	G	NR	NR
Indoor Use	EX	EX	EX	EX	EX	VG	EX	VG	F	F	F	NR	NR	NR	NR

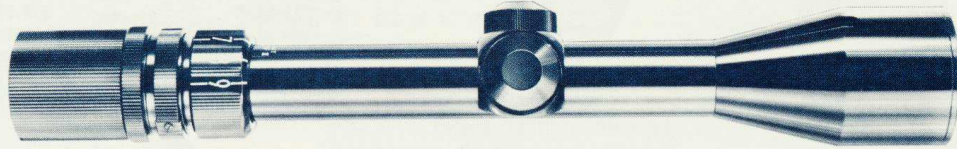
\* Built-in Ultra-violet filters on all Featherlight II models.

\*\* Exclusive optical system offers both eyeglass and non-eyeglass wearer the same full viewing field.

The ONLY scopes with TWO separate reticles in ONE scope!!!



#70-1282 — COMPACT, LOW-MOUNTING, 2.5x-8x VARIABLE, \$94.50



#70-1392 — FULL POWER, ALL-PURPOSE, 3x-9x VARIABLE, \$99.50

## Bushnell ScopeChief II

Now, TWO Great Variables with Exclusive Crosshairs and "Magnetic" Command Post proved most effective reticle for all hunting

- 20 Year Warranty

Bushnell optical engineers, hunters themselves, realize many times a whole year of plans and dreams is culminated in a single decisive shot. That shot just has to be good. In the ScopeChief II they made full use of the advance in optical developments and new materials at their command. In precision, accuracy, dependability, versatility, brilliance... the ScopeChief II is clearly superior to any riflescope available anywhere, at any price... truly an EXPERT'S HUNTING RIFLESCOPE.

The Bushnell Variable Scopes are the finest, most versatile precision optical instruments on the riflescope market today. This is the scope designed for the expert... the hunter who thrills to the joy of owning and using the best equipment money can buy. The serious hunter, who knows the success of his hunt depends on the perfection he demands in his equipment. Designed entirely without compromise, every specification reflects the quality optical engineering characteristic of all Bushnell products.

**Magnetic Command Post Control Ring** for split second, fingertip choice of two separate reticles... gives you 40 minutes more hunting time each day.

**Power Selection Ring** smoothly takes you through every power with sight picture constantly in focus; reticle position so they will not magnify as power increases.

**Precision Optical Principle** makes windage and elevation adjustments with hair-splitting accuracy and assuring retention of point of impact.

**Air Spaced Objective Lenses** for photographic clarity; flat distortion-free even at critical high powers.

**Precision Ground Optical Elements.** Every surface hard coated for greater luminosity in dimly lit brush, at dawn or dusk.

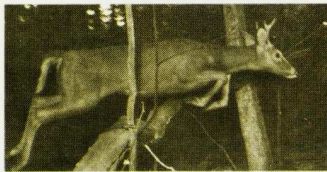
**Rugged Hard Anodized Finish** on streamlined 1" tube — virtually mar and scratch proof.

**Sealed for complete protection** from all weather conditions. Nitrogen filled to be trouble free from internal fog, moisture or dust.

**Generous Eye Relief** for maximum safety.

**Extra Wide Field** for ease in following moving game.

### WHICH RETICLE WOULD YOU USE, CROSSHAIRS OR POST?



Fast moving game at dusk: post



Well lighted varmint: crosshairs



Well lighted moving game: crosshairs



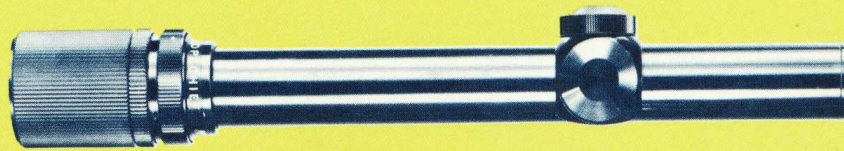
Game in brush: post

Your choice of reticles may differ from ours... but we do give you a choice. ONLY BUSHNELL gives you both crosshairs and Magnetic Command Post... TWO reticles at instant command in one scope!

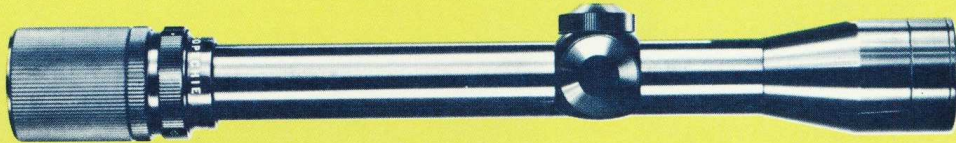
### Bushnell ScopeChief II Specifications

	3x-9x Variable Principle Settings				2.5x-8x Variable Principle Settings			Fixed Power Scopes		
	3x	4x	6x	9x	2.5x	4x	8x	2.75x	4x	6x
Magnification	3x	4x	6x	9x	2.5x	4x	8x	2.75x	4x	6x
Actual Magnification	3.0x	4.0x	6.0x	9.0x	2.7x	4.0x	8.0x	2.7x	4.0x	6.0x
Clear Aperture of Objective Lens	38mm	38mm	38mm	38mm	32mm	32mm	32mm	21mm	32mm	38mm
Exit Pupil	12.7 mm	9.5 mm	6.3mm	4.2mm	11.8mm	8.0 mm	4.0 mm	7.6mm	8.0 mm	6.3mm
Relative Brightness	157	90	40	18	140	64	16	58.4	64	40
Field of View @ 100 Yards	39'	31.5'	21.5'	13'	44'	30'	15'	43.5'	30'	20'
Eye Relief	3 1/2"	3 1/2"	3 1/2"	3"	3 1/2"	3"	2 3/4"	3 1/2"	3 1/2"	3 1/2"
Overall Length Focused to Infinity	12"	12"	12"	12"	11"	11"	11"	10 5/8"	11 7/8"	13"
Tube Diameter	1"	1"	1"	1"	1"	1"	1"	1"	1"	1"
Outside Diameter at Objective End	1.77"	1.77"	1.77"	1.77"	1.5"	1.5"	1.5"	1"	1.5"	1.77"
Outside Diameter at Eyepiece End	1.44"	1.44"	1.44"	1.44"	1.44"	1.44"	1.44"	1.44"	1.44"	1.44"
Weight	12 1/2 oz.	12 1/2 oz.	12 1/2 oz.	12 1/2 oz.	11 oz.	11 oz.	11 oz.	9 1/2 oz.	10 1/2 oz.	12 oz.
Click Adjustment @ 100 Yards (one half a graduation)	1/4"	1/4"	1/4"	1/4"	1/4"	1/4"	1/4"	1/2"	1/4"	1/4"
Crosshair Reticle Subtends @ 100 Yards	1"	.75"	.5"	.33"	1.2"	.75"	.38"	1.2"	.84"	.63"
Command Post Subtends @ 100 Yards	4"	3"	2"	1.3"	4.7"	3"	1 1/2"	5"	3.5"	2.3"
Mounts any standard height 1" Ring (on most rifles)	Finish — Hard Anodized — unscratchable from normal use									

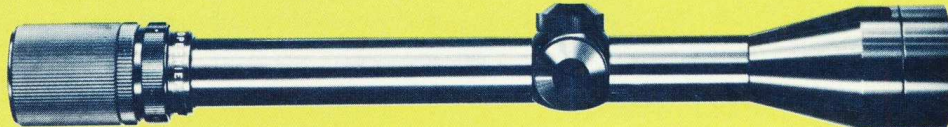
# Bushnell ScopeChief II Fixed Power Scopes



#70-1202—2.75x, for fast, accurate sighting on big game at short ranges in brush or wooded area, \$49.50



#70-1402—4x, choice of serious hunters for big game in open country at dawn, mid-day or dusk, \$59.50



#70-1602—6x, a powerful scope for long range open country shooting, \$69.50

The only fixed power scopes that give you two separate reticles in one scope, both crosshairs and Magnetic Command Post. Generous eye relief for maximum comfort and safety; wide field of view; all optics hard coated to give you superb luminosity and needle-sharp viewing edge-to-edge. The scope that spotlights game even in dimly lit areas. Nitrogen filled so they are fog and moisture proof; virtually scratch and mar proof hard anodized finish.

The unique ScopeChief II fixed power scopes provide more new advantages for successful hunting than any other fixed power scopes available. Precision windage and elevation adjustments for unequalled dead on accuracy and positive retention of point of impact.

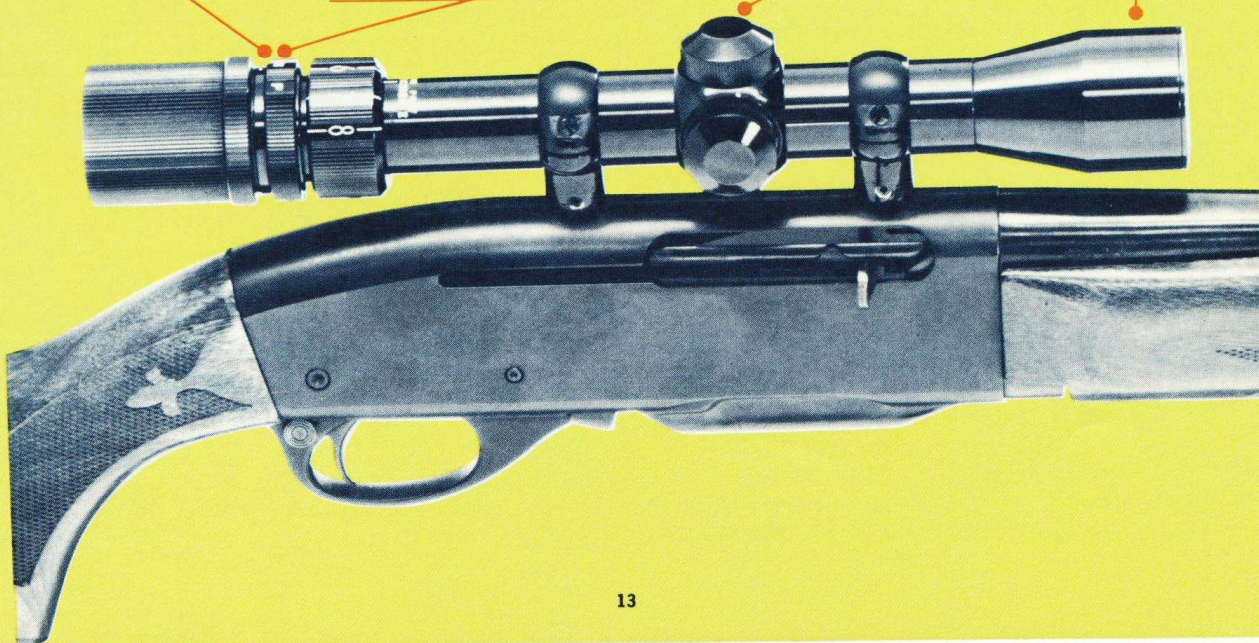
Reticles always permanently centered.

**Magnetic remote control of two separate reticles.** Make split second reticle changes from shooting position even while sighting on trophy game! The amazing new magnetic remote control ring for the famous Command Post gives you crosshairs for well lighted, open country, or with a flick of the fingers, a post flips up instantly for brush, dawn, or dusk. Command Post, proved most effective reticle for all hunting, gives you at least **40 minutes more hunting time each day.**

**Reticle always remains centered and same size.** Both reticles in the new ScopeChief II are always permanently centered for quick, accurate aiming. In the Variable, the reticle appears the same size through every power change, making it ideal for every hunting situation . . . from varmint to big game. Brilliantly engineered, with long eye relief and extra field of view. Neoprene sealed so you'll never be troubled with internal fog, moisture or dust. Built to take rugged duty, the Rhino-coat finish of the new ScopeChief II is virtually mar and scratch proof.

**Unequalled precision accuracy.** Each adjustment operates independently on dovetails so movement of one cannot affect the other, assuring unerring and positive retention of point of impact. When hunting a variety of game in vast, rugged areas or anywhere else, you can accurately change point of impact for each bullet weight and return to exact zero every time. Built-in safety stop prevents screw from turning so far that adjustment mechanism pops out, as can happen with many popular scopes.

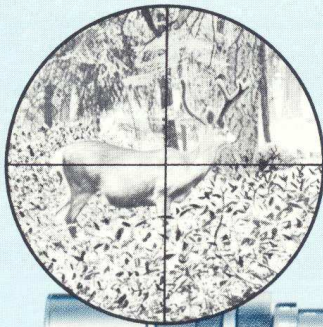
**Air spaced objective lenses,** time-proven in expensive precision cameras, are now a major advance in riflescope optical systems. This makes possible finest visual corrections and a field of view, needle sharp, flat and distortion free edge to edge, even at the more critical high powers. Every lens surface hard coated for greater luminosity, allowing you to hunt earlier in the morning and well into twilight.



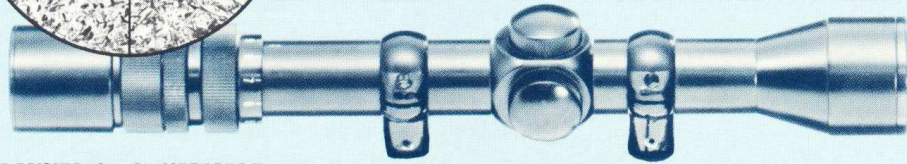
Rugged,  
dependable,  
economy-priced . . .

## Bushnell Banner Riflescopes

- Reticle always remains centered
- Same size through every power in Variable
- Finest hardcoated lenses
- Precise adjustments
- Nitrogen filled
- 5 Year Warranty



**MB**



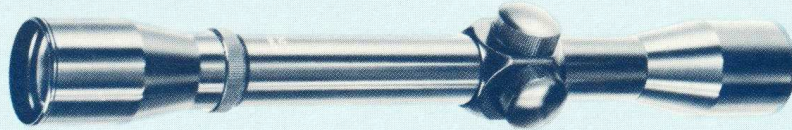
### BANNER 3x-9x VARIABLE

At last, a budget-priced Variable. Designed for the hunter who has dreamed of combining optical precision and versatile magnification with a budget price. Reticle **always remains centered** in field of view, and **same size** as you zoom from 3x to 9x. Maintains constant, sharp sighting image through every power change by use of two precision cams. Finest hard-coated lenses for highest luminosity. Precise reticle adjustments for windage and elevation. Sealed to keep out dust and moisture.

#71-1392 (crosshairs) (Universal Mount, illustrated, not included) **\$49.50**

**SPECIFICATIONS:** Overall Length 11 $\frac{3}{8}$ " ; Eye Relief 3"-3 $\frac{1}{2}$ " ; Weight 13 $\frac{1}{2}$  oz. ; Clear Aperture of Obj. Lens 1.26"

Eyepiece Magnification	3x	4x	5x	6x	7x	8x	9x
Field at 100 yds.	39'	28'	22'	19'	16'	14'	13'
Diam. of Exit Pupil	10.7mm	8mm	6.4mm	5.3mm	4.6mm	4mm	3.6mm

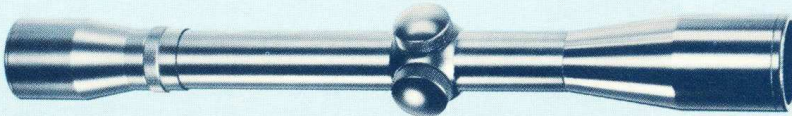


### BANNER 4x

**Versatile 4x.** Popular, economy-priced 4x rifle scope, tough and rugged for all-around hunting. Reticle **always remains centered** in field of view. Precision reticle adjustments provide extreme accuracy. Finest hard-coated lenses for highest luminosity. Sealed to keep out dust and moisture.

#71-1402 (crosshairs) or #71-1412 (post) **\$37.50**

**SPECIFICATIONS:** Overall Length 11.75" ; Weight 9 oz. ; Eyepiece Diam. 1.42" ; Eye Relief 3.5"-5" ; Objective Diam. 1.50" ; Objective Lens 1.26" ; Exit Pupil 8mm (.315") ; Field at 100 Yds. 30' ; Tube Diam. 1"

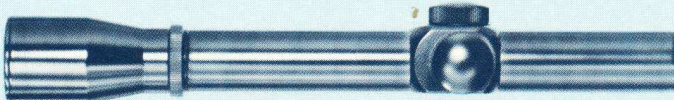


### BANNER 6x

**Varmint and Long Range.** High power for varminting and long range. Reticle **always remains centered** in field of view. Finest hard-coated lenses for highest luminosity. Precision reticle adjustments provide extreme accuracy. Sealed to keep out dust and moisture.

#71-1602 (crosshairs) **\$39.50**

**SPECIFICATIONS:** Overall Length 13.25" ; Weight 10 oz. ; Eyepiece Diam. 1.42" ; Eye Relief 3.75" ; Objective Diam. 1.50" ; Objective Lens 1.26" ; Exit Pupil 5.7mm (.224") ; Field at 100 Yds. 19.5' ; Tube Diam. 1" ; Shipping Weight 1 lb. 8 oz.



### BANNER 2.5x

**Wide Field 2.5x.** Ideal for big game — small, lightweight with a wide field for following moving game. Reticle **always remains centered** in field of view. Precision reticle adjustments provide extreme accuracy. Finest hard-coated lenses for highest luminosity. Sealed to keep out dust and moisture.

#71-1202 (crosshairs) or #71-1212 (post) **\$29.50**

**SPECIFICATIONS:** Overall Length 10.62" ; Weight 8 oz. ; Eyepiece Diam. 1.42" ; Eye Relief 3.5"-5" ; Objective Diam. 1" ; Objective Lens .78" ; Exit Pupil 8.4mm (.332") ; Field at 100 Yds. 45' ; Tube Diam. 1" ; Shipping Weight 1 lb. 1 oz.

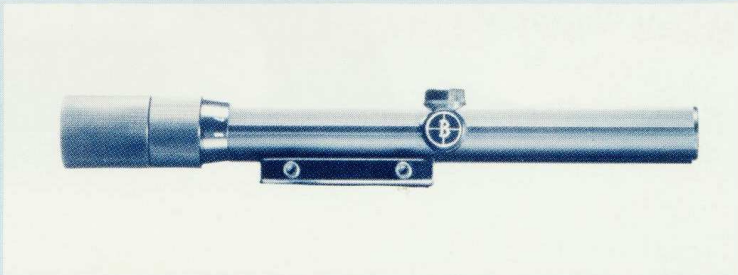
Mount it where  
**YOU** need it  
 on your  
 .22 rifle scope



## NEW ScopeChief II 22 Riflescopes

- Integral mounting rail
- Reticle always centered
- 7/8" tube gives wider field
- Precision adjustments; fully coated lenses
- 20 Year Warranty

Here are the handsomest .22 scopes you've ever seen. A unique mounting rail going the full length of the scope lets you position it exactly where you want it, even on those .22's previously a problem. Crosshairs always remain centered in field of view. Full 7/8" tube for wider field, better eye relief. All lenses low-reflection coated for highest luminosity. Ultra fine, precision micrometer wind-age and elevation adjustments assure unfailing adjustment accuracy. New glare free ribbed surface protects against marring and scratching. Mountings included in price.



Shipping weight: 1 lb. 2 oz.

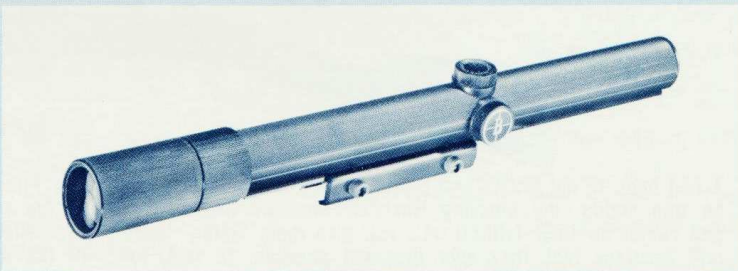
#70-3100 — 3x-8x ScopeChief II 22

**\$19.95**

Here's a full range of magnifying powers for accuracy in every shooting situation from hunting small game to a youngster learning shooting and hunting safety while plinking at tin cans. Reticle always centered.

### SPECIFICATIONS

Magnification	3x	4x	5x	6x	7x	8x
Field @ 100 Yds.	30'	24'	18'	16'	14'	12'
Exit Pupil	7.4mm	5mm	4mm	3.4mm	2.9mm	2.5mm
Overall Length: 11", Weight: 7½ oz., Clear Aperture of Objective Lens: 20mm.						
Outside Diameter of Eyepiece End: 1-3/16", Outside Diameter of Objective End: 7/8", Diameter of Tube 7/8", Eye Relief: 2¼"-3".						



Shipping weight: 1 lb. 2 oz.

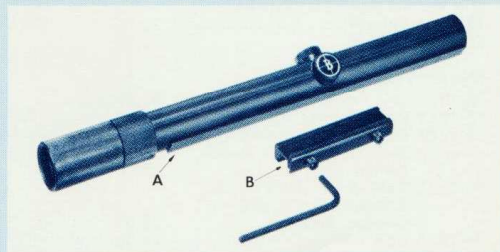
#70-3000 — 4x ScopeChief II 22

**\$14.95**

Wide 30' field of view and a bright, sharp sight picture make it easy to follow running game or reach out and take game you'd miss with ordinary sights.

### SPECIFICATIONS

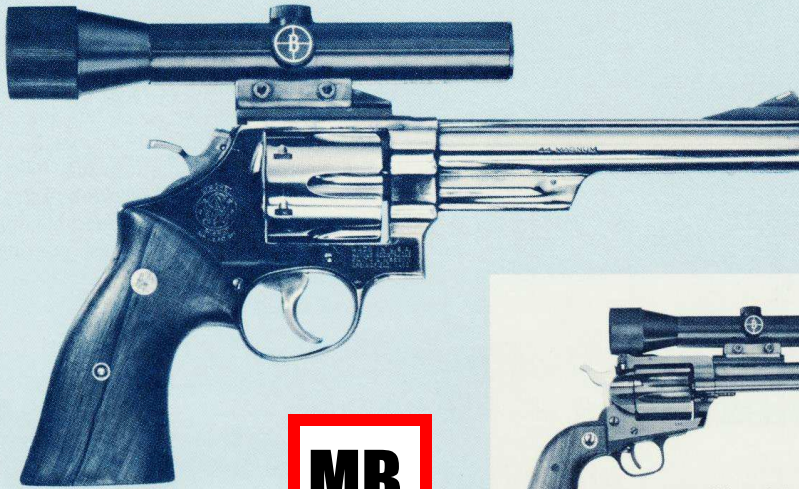
Field @ 100 Yds.: 30', Exit Pupil: 5mm, Overall Length: 11", Weight 5½ oz., Clear Aperture of Objective Lens: 20mm, Outside Diameter of Eyepiece End: 1-1/16", Outside Diameter at Objective End: 7/8", Diameter of Tube: 7/8", Eye Relief: 2½".



Unique Dovetail Mounting Rail (A) lets you slide scope far forward or far back in mount (B) to position it exactly where **you** need it.

# Bushnell Phantom Scopes

- New Accuracy
- Sharp Focus
- Precision Adjustments
- 20 Year Warranty



#74-1900  
1.3x PHANTOM  
(all-purpose game and target)  
\$24.50



#74-1901  
2.5x PHANTOM  
(Varmint and long range)  
\$34.50

### WHY SCOPE A PISTOL?

It's a known fact that no human eye can focus on both iron sights and target at the same time. With the Phantom, crosshair and target are one razor-sharp image that remains bright and clear even when lighting is poor. The Phantom gives perfect clarity of sight and permits extremely accurate holding on target because crosshair and target are on the same plane of vision. This single sighting plane plus micrometer reticle adjustments give precision not possible with iron sights. Target remains sharp and clear even with poor lighting. All optics are hard coated to give greater luminosity.

Magnification	1.3x	2.5x
Weight	5 oz.	5.5 oz.
Length	7 <sup>5</sup> / <sub>8</sub> "	9 <sup>1</sup> / <sub>4</sub> "
Eyepiece Diameter	1.4"	1.4"
Eye Relief	6"-17"	7"-16"
Objective Diameter	7 <sup>7</sup> / <sub>8</sub> "	7 <sup>7</sup> / <sub>8</sub> "
Exit Pupil	20.7mm	10mm
Field at 100 Yds.	24'	10'

### RIGID TOP MOUNTS SECURE PHANTOM

Rigid Top Mounts are your best mount choice for either light or heavy calibers. They screw firmly to top strap when rear sight is removed and secure Phantom so it will not budge or change point of impact even with the heaviest loads. See below.



— for Model 94 Winchester — other rifles, too

A real boon to old timers and those who have trouble focusing on iron sights, the amazing Bushnell Phantom Scope front and center on their faithful 94's will give them faster, "dead on" accuracy that they ever dreamed possible. In fact, for any shooter the Phantom beats open sights for faster, more accurate shooting. There's absolutely no safety problem in mounting because there's no need to drill or tap the barrel.

The Phantom mounts easily in the dovetail slot just forward of the receiver, to allow for top ejection of cartridge. Long eye relief lets the shooter utilize the large unrestricted field of the naked eye around the scope, and through the scope both target and crosshairs are crystal clear . . . the fastest possible combination for brush shooting or close range on running game.

## Mounts and Holsters for Bushnell Phantom Scopes

### Phantom Handgun Mounts

- Clip Mounts (for light calibers)
- 76-1910 Colt Officer's Model Match .22 \$5.00
- 76-1913 Ruger Single Six \$5.00
- 76-1912 S&W K .22 \$5.00

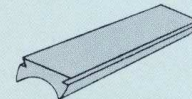
### Rigid Top Mounts

- 76-1911 Colt Frontier Scout \$5.00
- 76-1913 Ruger Single Six \$5.00
- 76-1920 Colt Python; Three-Fifty-Seven; Trooper; Officer's Model Match; New Frontier \$5.00
- 76-1921 S&W K-22; K-32; K-38; Combat Masterpiece; Combat Magnum \$5.00
- 76-1922 S&W .22 Jet \$5.00
- 76-1923 S&W .38/44 Outdoorsman; 45 Target 1955; .357 Magnum; Highway Patrolman; .41 Magnum; .44 Magnum \$5.00

- 76-1924 Remington XP100 \$5.00
- 76-1925 Ruger .256 Hawkeye \$5.00
- 76-1926 Ruger Blackhawk; Super Blackhawk; Super Single Six \$5.00
- 76-1927 Ruger 10/22 (Phantom and .22 Scopes) \$5.00

### Phantom Rifle Mounts

- 76-1916 Center Dovetail — no drilling or tapping. Also suitable for Winchester models 73, 86, 92, 94, 95, 07, 10, 43, 53, 54, 55, 64, 65, 70, 71, 74 and Single Shots; Marlin models 93, 94, 95, 27, 336; Remington models 30, 30S, 141, 721, 722; Savage models 99, 20, 40, 45, 340, 342; Stevens models 322, 325; Mossberg models \$5.00



### Standard Dovetail Mount Blanks

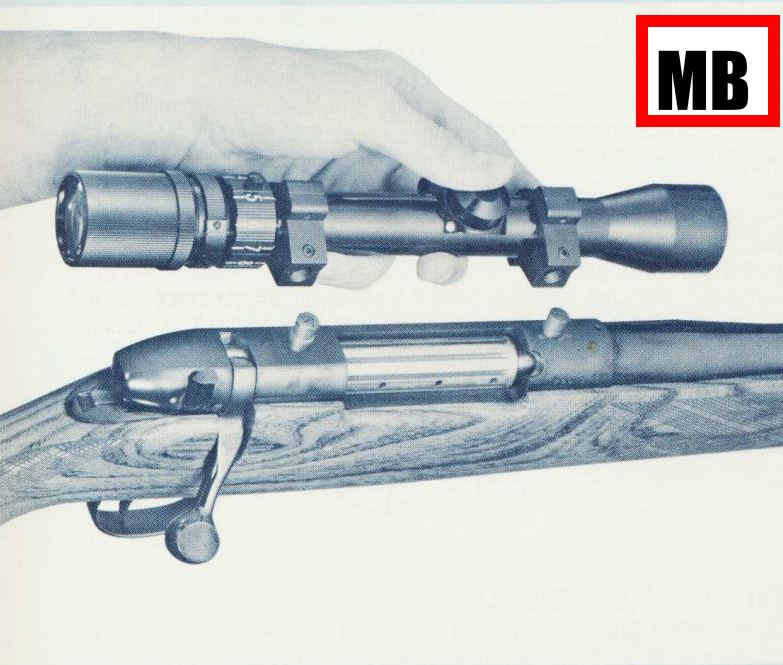
For custom scope mounting on handguns and rifles. Standard dovetail specification (SAAMI), hardened, de-burred, unanodized aluminum alloy blanks.

- 76-1917 Approx. 3/8" radius; length 2.25"; width .51"; height .27" \$2.00
- 76-1918 Approx. 5/8" radius; length 1.77"; width .51"; height .21" \$2.00

### Holsters for Scoped Handguns

Saddle leather belt type, tan or black, right or left hand. Specify gun. each \$9.95  
Saddle leather with detachable shoulder strap and belt loop, tan only. Specify gun . . . each \$17.95





## Bushnell Universal Mount\* For Riflescopes

- **STRONG** — Passes Toughest Torture Tests
- **SIMPLE** — Installs Without Special Tools
- **VERSATILE** — Positions Scope Precisely
- **UNIVERSAL** — Fits Any Rifle

\*U.S. and Foreign Patents Pending

### NOW... ONE SIMPLE, ECONOMICAL MOUNT DOES ALL!

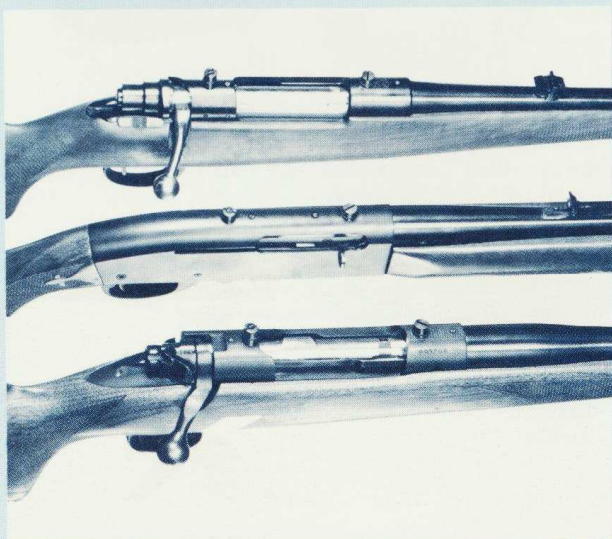
The new Bushnell Universal Mount fits any rifle with drilled and tapped receiver. Two 6-48 screw-in studs secure any 1" scope directly to receiver . . . eliminate the need for special mount bases.

Studs are made of chrome-moly steel, heat-treated to 200,000 pounds per square inch tensile strength . . . the strength of critical jet-plane landing gear fasteners.

The two studs set into any combination of scope-screw holes that positions the scope for best eye relief. Variations in stud collars compensate for contour and height differences in receivers, provide bore-sighting elevation adjustments. Apertures in the undersides of the 1" split rings fit over studs (illustration above), are designed with bore-sighting windage adjustments.

The Bushnell Universal Mount is the strongest, most versatile yet devised . . . does the best job of positioning scopes for precise eye relief . . . economical, too!

**Bushnell Universal Mount Set** (set of studs and 1" split rings):  
 #76-2000, with blued steel split rings . . . . . \$14.95  
 #76-2001 set of studs only . . . . . \$5.00



### TEST AFTER TEST . . .

. . . prove the strength, simplicity and versatility of the Bushnell Universal Mount. Even the experts were skeptical at first. But, here's what their test reports say:

"A lot of people probably thought that just two screw-ins holding a scope wouldn't be enough . . . no signs of any trouble's developing, and the rifle is still shooting right where I sighted it in . . . pretty sensational."

**Pete Brown, SPORTS AFIELD**

"I was suspicious . . . However, nothing moved with the heavy recoil and zero was maintained. An excellent idea . . ."

**Pete Kuhlhoff, ARGOSY**

"My test of Universal Mount and 2.5x - 8x ScopeChief II on Weatherby's .460 Magnum failed to budge either scope or mount."

**Elmer Keith, GUNS & AMMO**

"The studs showed no sign of abnormal impact shift, though I pounded the rig — and my shoulder — with almost half a dozen boxes of G.I. ammo."

**Warren Page, FIELD & STREAM**

"The epitome of simplicity . . . No problems at all were encountered. Installation was quick and easy."

**SHOOTING TIMES**

"No evidence of damage whatever from the strain of firing."

**SPORTS AGE**

### CORRECT EYE RELIEF

Two chrome-moly studs screw into any one of four combinations of screw holes . . . permit precision positioning of the scope for best eye relief . . . handle 98% of all eye relief situations. With studs installed on several rifles, one scope can be easily moved from rifle to rifle. No special tools required.

# Bushnell Shooting Glasses

for the hunter . . .  
competitive shooter . . .  
an occasional day  
at the range . . .  
or just the fun  
of plinking  
at an old tin can

**MB**

For the thoughtful person who considers the dangers to his eyes, the shooting glass with lenses four times stronger than optical glass is as important as the ammunition he uses. BUSHNELL CUSTOM SHOOTING GLASSES GIVE NEEDED EYE SAFETY from ricocheting shot, powder gases, wind and dust. Larger than normal, they ride high on the bridge of nose to cover eye in sighting position; frame offers no obstruction to sight. Lenses optically ground and polished to eliminate aberrations and distortions — hardened by a special process to make them virtually break proof. 1/12 K gold filled wire frames — comfortably light weight with nose pads brackets that easily form to fit the individual. Nylok, non loosening hinge screws. Hard case included.

BUSHNELL YELLOW SHOOTING GLASSES SHARPEN THE VISION and enhance the shooter's effectiveness under poor light conditions — when the hunting is best. Yellow lenses filter out glare producing ultra violet light waves — there is a noticeable brightening effect and improvement of contrast. Sharpens vision to pick out game in brush and woods. Also suitable for night driving.



## FINEST QUALITY CUSTOM SHOOTING GLASSES

#80-2000 YELLOW LENSES \$18.95 — filters out ultra violet waves, noticeably improves contrast and sharpness of vision (91% light transmission in the visible spectrum)

#80-2001 GREEN LENSES \$18.95 #1 light green — sharp clear vision maintained in sunshine (79% light transmission in the visible spectrum)

#80-2002 GRAY LENSES \$18.95 #1 light gray — maintains neutral color of all objects viewed (40% light transmission in the visible spectrum)

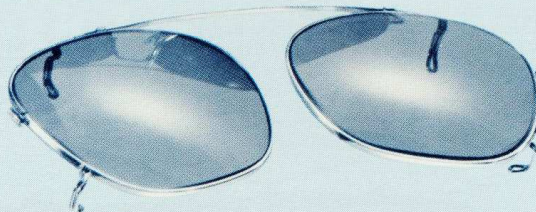


## SPORTVIEW SHOOTING GLASSES — PROTECTION WITH ECONOMY

#80-2003 YELLOW LENSES \$12.95 — impact resistant, optically ground and polished lenses. Gold plated frame. Hard case.

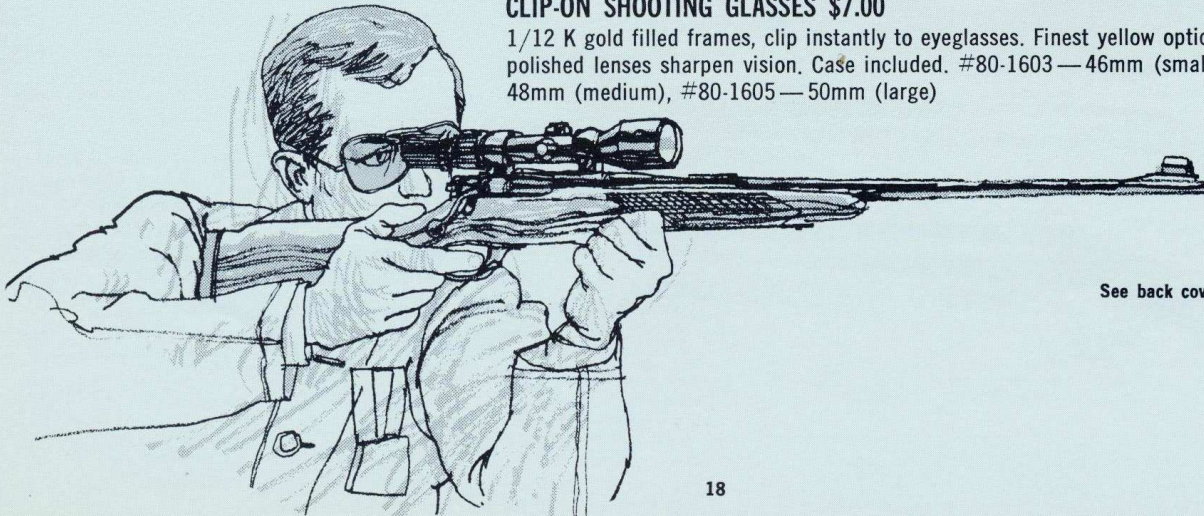
#80-2004 GRAY LENSES \$12.95 — gray, impact resistant, optically ground and polished lenses. Gold plated frame. Hard case.

#80-2010 YELLOW LENSES \$12.95 — impact resistant, optically ground and polished lenses. Tortoise shell frames. Hard case.



## CLIP-ON SHOOTING GLASSES \$7.00

1/12 K gold filled frames, clip instantly to eyeglasses. Finest yellow optically ground and polished lenses sharpen vision. Case included. #80-1603 — 46mm (small), #80-1604 — 48mm (medium), #80-1605 — 50mm (large)



See back cover for Sunglasses.

# Bushnell Spotting Scopes



- finest hard-coated high resolution optics
- outstanding image sharpness
- remarkable versatility

## SPACEMASTER 60mm prismatic telescope

The finest all-around telescope you've ever seen! Perfect for any specialized use requiring highest resolution, brightness and contrast. Ideal for applications ranging from nature study to amateur astronomy. (Spacemaster combined with precision camera adapter is also an outstanding telephoto lens. See page 21).

Amazing clarity and brilliance is achieved with finest achromatic, color-corrected, coated optics . . . featuring fingertip focusing. Neutral gray, interchangeable eyepieces, retractable sunshade, integral tripod boss, moisture and dust-proof. Protective caps for eyepiece and front lens included.

Weight: 39 oz. Maximum height: 3-5/16". Overall length: 15 1/4".

#78-2025 with 25x eyepiece (or your choice of 15x, 20x or 40x) .....\$95.00



## SPACEMASTER 45° 60mm prismatic spotting scope

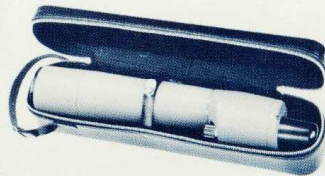
Designed specifically to help you achieve top accuracy in target shooting. Scientifically angled eyepiece lets you check shots quickly, without moving from firing position. This means faster, more accurate shooting without strain or fatigue. Hard-coated, achromatic optics. Fingertip focusing system. Protective knob to guard against accidental movement. Neutral gray finish, interchangeable eyepieces, retractable sunshade, moisture and dustproof. Weight: 43 oz. Maximum height: 5". Overall length: 16 1/4".

#78-2125 with 25x eyepiece (or your choice of 15x, 20x, or 40x) .....\$99.50

### SPACEMASTER SPECIFICATIONS

Magnification	At 1000 Yds.	Exit Pupil
15x	158 ft.	4mm
20x	124 ft.	3mm
20x Wide Angle	175 ft.	3mm
25x	105 ft.	2.4mm
40x	61 ft.	1.5mm
60x	32 ft.	1mm

(Tripod prices and descriptions page 20)



### SPACEMASTER ACCESSORIES

Extra Eyepieces (either model) 15x, 20x, 25x, 40x, 60x Celestial (specify) .....	22.50
78-2221 20x Wide-Angle Eyepiece .....	27.50
78-2029 Amplifier for Str. Spacemaster increases 15x, 20x or 25x eyepieces 2 1/2 times .....	22.50
78-1199 4-Eyepiece Turret for quick interchange .....	22.50
78-3001 Shooter's Tripod (illus.) .....	21.95
78-4000 Elvin Alt-Azimuth Mount .....	9.95
16-9100 Deluxe Case for Straight Spacemaster .....	10.00
16-9200 Deluxe Case for 45° Spacemaster .....	10.00



## BUSHNELL SENTRY 50mm prismatic spotting scope

Terrific value for pistol or rifle shooter. Finest hard-coated, high resolution optics. Extremely compact, has retractable sunshade, tripod socket. Great space saver for field use, weighs only 24 oz., 13" long with protective caps. Neutral brown crystal finish with 20x eyepiece.

#78-1020 with 20x eyepiece .....\$54.50

### Sentry Specifications

Eyepiece Magnification	20x	32x	48x
Field at 1000 yds.	131 ft.	76 ft.	40 ft.
Diameter of Exit Pupil	2.6mm	1.7mm	1.1mm

### Sentry Accessories

Extra Eyepiece 20x, 32x, 48x, each .....\$19.50  
Shooter's Tripod (illustrated).

Lightweight, extremely rigid, micro-screw adjustments, worm-screw ring clamp. Can be folded with scope attached. Durable aluminum with crystal gray finish.

#78-3001 .....\$21.95

## COMPACT, ECONOMY 40mm spotting scope, 9x-30x ZOOM

Sleek, compact (only 15" long), and a top performer, too. Excellent for shooters, hunters, bird watchers . . . or anything watchers. A unique integral wheel lets you zoom quickly and easily from power to power continuously in focus from infinity right down to 25 feet. Coated optics. Standard tripod boss. Weight only 22 ounces.

#78-1930 .....\$29.50

#78-3003 Shooter's Stand Tripod (for above #78-1930 only) Lightweight, compact, lever controlled adjustments, extendable tube for varying height, folding legs. Black metal. \$9.95

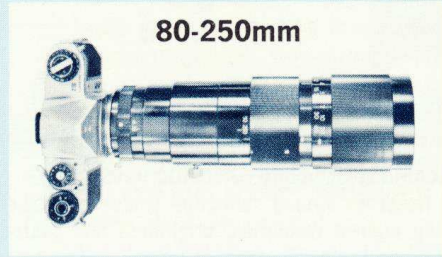
#78-3004 Table Top Tripod (illustrated) .....\$2.95



# Bushnell Zoom Telephoto Lenses



- 80-250mm
- 95-250mm
- 20-year warranty



80-250mm

**NEW, AUTOMATIC f 3.8  
ZOOM TELEPHOTO LENS**

- Fully Automatic Diaphragm
- Instant Zoom Control

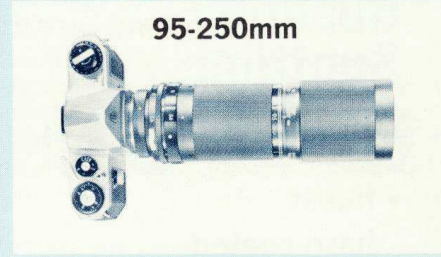
This new lens combines the most popular and practical focal length range, 80-250mm, with a fully automatic diaphragm system and a maximum speed of f:3.8. Extraordinarily fast, it captures high speed action: news reporting, sports events, running game, antics of a growing child.

The fully automatic diaphragm system always allows the convenience of focusing and composing shots with aperture wide open from 6½ feet to infinity. No chance of spoiling a perfect shot because of a forgotten open diaphragm. A quick, quarter turn (90 degrees) of the zoom ring gives the full range of focal lengths. The specially designed built-in cam system provides for compensation which assures perfect focus through the entire zoom cycle from 80mm to 250mm.

Fully corrected for all aberrations, the lens provides high definition even to the remotest corners, assuring sharp and contrasty effect throughout the frame.

**SPECIFICATIONS:** Zoom Focal Lengths: 80mm - 250mm; Speed: f:3.8; Lens Construction: 9 groups, 14 elements; Angle of View: 30° (80mm) - 9°43' (250mm); Setting: f:3.8, 5.6, 8, 11, 16, 22; Minimum Focus: 6.5 ft.; Diaphragm System: Fully automatic; Focus Mechanism: Helicoid; Zoom System: Helical motion (with mechanical compensation), quarter rotation of zooming ring covers entire zooming range; Filter Size: screw-in, 72mm; Overall Length: 9.48"; Weight: 44.6 oz.; Tripod Socket Ring (rotatable through 360 degrees). Infra Red Scale; Leather Case.

Available only for the following single lens reflex cameras with removable lenses: #20-0252: Pentax, Praktica; #20-0253: Nikon; #20-0254: Canon; #20-2055: Minolta; #20-2056: Miranda, each \$285.00  
#20-2057: Lens Hood for all models, \$5.95



95-250mm

**NEW, LIGHTWEIGHT f 5.6 PRE-SET,  
ZOOM TELEPHOTO LENS**

- Pre-Set Diaphragm
- Positive Click Stop Settings

Compact, lightweight, easy to use, the Bushnell 95-250mm Zoom Telephoto opens a whole new world of opportunities you never dreamed possible. You move quickly and smoothly from focal length to focal length, always in focus.

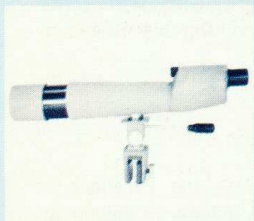
Or, you change focus and zoom simultaneously with one hand. You frame vacation and travel pictures or family candids just the way you want with a variety and flexibility impossible to achieve with a normal lens.

Focusing of the 9-element lens is crisp and sharp from 8 feet to infinity. The straight slide zoom system is quick and easy to use. Preset aperture control system has positive click stop settings, f:5.6 to f:22. T-mount adapters are available to fit most focal plane shutter cameras.

**SPECIFICATIONS:** Zoom Focal Lengths: 95-250mm; Speed: f:5.6; Lens Construction: 7 groups, 9 elements; Angle of View: 25°36' (95mm) - 9°48' (250mm); Settings: f:5.6, 8, 11, 16, 22; Minimum Focus: 8 ft.; Diaphragm Mechanism: click stop, preset system; Focus Mechanism: Helicoid; Zoom System: straight slide; Filter Size: screw-in, 62mm; Overall Length: 7.87"; Weight: 21.7 oz.; Tripod Mounting Base; Infra Red Scale; Interchangeable Camera Adapter Mount; Leather Case.

- #20-0250 95-250mm Zoom Telephoto Unit with case (includes #20-0001 T-adapter for Pentax, Praktica, Yashica, Penta J. Edixa) . . . \$159.50
- #20-0251 Lens Hood . . . 5.95
- #20-0001 T-adapter for Pentax, Praktica, Yashica, Penta J., Edixa . . . 2.50
- #20-0002 T-adapter for Exakta, Topcon RE . . . 5.00
- #20-0003 T-adapter for Nikon . . . 5.00
- #20-0004 T-adapter for Minolta SR . . . 5.00
- #20-0005 T-adapter for Canonflex . . . 5.00
- #20-0006 T-adapter for Miranda . . . 2.50
- #20-0007 T-adapter for Konica . . . 5.00
- #20-0008 T-adapter for Olympus Pen F . . . 9.00
- #20-0009 T-adapter for Mamiya Prisma . . . 4.00

## Bushnell Tripods



**Car Window Mount**  
Clamps easily on car window to provide steady base for viewing or telephotography base. Pan head tilts for vertical use. Height: 4¾". Weight: 20 oz.  
#78-4001 \$11.95



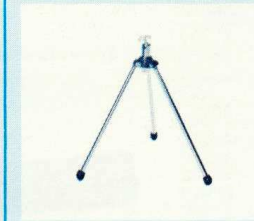
**Zoom Spotting Scope Tripod**  
Lightweight, compact, lever-controlled adjustments, extendible tube for varying height, folding legs, black metal. (For #78-1930 only.)  
#78-3100 \$22.95



**Shooter's Stand Tripod**  
Designed especially for bench or prone position. Micro fine adjustments. Height: 10½". W.: 2 lbs. 8 oz.  
#78-3001 \$21.95  
12" Extender for above.  
#78-3002 \$3.50

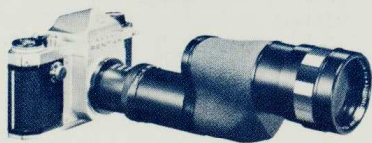


**Table Top Tripod**  
Light and compact. Has ball socket head adjustment, standard thread. Chrome plate finish. Rubber tipped legs protect against scratching. Height: 7½". W.: 10 oz.  
#78-3004 \$2.95

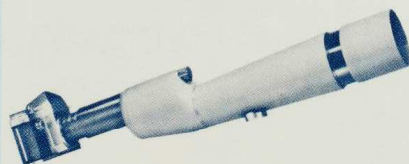


**Table Top Tripod**  
Light and compact. Has ball socket head adjustment, standard thread. Chrome plate finish. Rubber tipped legs protect against scratching. Height: 7½". W.: 10 oz.  
#78-3004 \$2.95

350-650mm



750-3000mm



# Bushnell Double-Duty Telephoto Lenses

**MB**

350-650mm  
750-3000mm  
20-year warranty

## COMPACT, VERSATILE TELEVAR VARIABLE LENS

The versatile TeleVar offers long-range telephoto at a modest price — provides zoom performance in a compact instrument. TeleVar lets you capture exciting sport pictures, rare closeups of animals, extraordinary detail shots of buildings and statues, delightful candid shots of children at play. These and thousands of other breathtaking scenes and events that have always been beyond the reach of the normal camera lens can now be yours.

Lightweight TeleVar travels easily, is always ready for instant use. Focal lengths from 350 to 650mm let you frame the exact picture you want without changing your location.

TeleVar adapts simply to most 35mm and 2 1/4 x 2 1/4 single lens reflex cameras. (For SLR cameras with removable lenses, check availability list below. For those with non-removable lenses, check fixed focal length telephoto list below.) Knurled front lens ring provides rapid, precise focusing. A series of four exposure control discs provides greater depths of field, when desired. TeleVar serves double duty as a superb monocular for sports events, nature study, travel, every viewing pleasure.

## TELEVAR VARIABLE TELEPHOTO OUTFIT

Length: 7 1/4". Weight: 19 oz. Shipping Weight: 3 lbs. The TeleVar Telephoto Outfit includes: (1) TeleVar Monocular, (2) 350-650mm Variable Mount, (3) Carrying Pouch, (4) Set of four Exposure Control Discs.

## HOW TO ORDER:

- A. Specify "Complete TeleVar Variable Outfit" @ \$59.50
- B. Give name of camera (check availability list)
- C. Add cost of adapter, if required.

## ACCESSORIES

#21-0011	Filter Holder & Near Focus Lens	7.95
#21-0012	Exposure Control Discs (set of 4)	1.00
#21-0013	Iris Diaphragm & Lens Hood	14.50
#21-0014	Tripod Adapter and Support	5.00
#21-0015	Soft Leather Carrying Pouch	4.95
	Extra Variable Mounts (Give name of camera; see availability list)	15.00

## TELEVAR 325mm FIXED FOCAL LENGTH TELEPHOTO OUTFITS

For the following single lens reflex cameras (with non-removable lenses):

Agfaflex	Kowaflex
Aries Penta 35	Kowaflex E
Astraflex II	Minolta ER
Bronica	Nikkorex 35
Exakta 66	Optika 11a
Fujicorex	PCA Prismat, V90
Kodak Retina Reflex (f:2)	Pentina
Kodak Retina Reflex (f1.9)	Praktisix Reflex 66

The TeleVar 325mm Fixed Telephoto Outfit includes (1) TeleVar Monocular, (2) Fixed focal length Mount, (3) Step-down-to-series-V Filter Ring, (4) Carrying Pouch, (5) Set of four Exposure Control Discs. (In addition, a standard filter ring adapter is needed, available from your camera dealer.) When ordering, give name of camera and specify:

TeleVar 325mm Fixed Focal Length Outfit . . \$52.00

## EXTRA-LONG RANGE SPACEMASTER TELEPHOTO LENS

Here, at last, is an extra-long-range lens that takes superb pictures of unapproachable subjects with virtually all 35mm single lens reflex cameras (with removable lens, only — check availability list, below). Light and compact it carries easily in one hand. Best of all, Spacemaster is priced for every photographer. Spacemaster focal lengths range from 750mm to 3000mm, depending on interchangeable eyepiece in use: 15x eyepiece — 750 to 1500 mm; 20x — 1500 to 2160mm; 25x — 2160 to 3000mm. Some cameras vary the focal length, as noted on availability list.

Variable mount is clearly engraved with focal length and f:stop values for quick, accurate selection of telephoto effects. Spacemaster connects directly to camera body with absolute alignment and rigidity. Its prism-shortened air column reduces internal turbulence.

Used separately, Spacemaster is an outstanding all-purpose telescope for nature study, target spotting, star-gazing, and general year-'round pleasure — a bonus you'd never expect from such a superb telephoto lens.

## SPACEMASTER TELEPHOTO OUTFIT

Length: 17". Weight: 39 oz. Shipping Weight: 4 lbs. Spacemaster Telephoto Outfit includes (1) Telescope, (2) Variable Mount, (3) One Eyepiece.

## HOW TO ORDER:

- A. Specify "Complete Spacemaster Telephoto Outfit" @ \$110.00
  - B. Specify Eyepiece (15x, 20x or 25x)
  - C. Give name of camera (check availability list)
  - D. Add cost of adapter, if required.
- Complete outfit with 3 eyepieces . . . . . \$155.00

## ACCESSORIES

#78-2215	Extra 15x eyepiece	\$22.50
#78-2220	Extra 20x eyepiece	22.50
#78-2225	Extra 25x eyepiece	22.50
#22-3011	Near Focus Lens #1 (7.5'-13')	9.95
#22-3015	Exposure Control Discs (set of 4)	9.95
#22-3016	Extension Saddle; recommended to stabilize tripod-mounted Spacemaster	3.95
	Extra Variable Mounts (specify camera)	15.00
#78-9100	Case for Spacemaster	10.00

## AVAILABILITY LIST SPACEMASTER AND TELEVAR VARIABLE TELEPHOTO OUTFITS

Spacemaster and TeleVar Outfits are available for the following single lens 35mm reflex cameras only. When ordering, name your camera. (See "How to Order" above.) Add cost of adapter, if required (see footnote for prices).

Alpa*	Exakta, 35mm models	Petri Penta
Astra 35	Hexacon	Petri Penta V, V2*****
Astraflex 35	Kodak Retina Reflex S, III, IV†	Praktika IV, FX2, FX3
Besseler Topcon R, B, C, D	Konica, all models***	Praktiflex
Braun Paxette†	Korrelle Reflex	Praktina FX, 11A****
Canon, all models**	Leicaflex, all models	Rival Reflex
Canonflex**	Minolta, all models****	Tower 26, 29
Catalina Reflex	Miranda, all models***	Tower 33, 34†
Contarex**	Nikon F**	Tower 32A, 37
Contax D, K, S	Nikkorex F**	Voigtlander Bessamatic, Ultramatic†
Edixa Mat B, B-L, C, D	Pentacore	Yashica Pentamatic S**
Edifax B	Pentax	Yashica Penta J, TL
Exa. 35mm models		

Camera Body Adapter required: \*-\$17.95, \*\*-\$6.95, \*\*\*-\$9.95, \*\*\*\*-\$4.95, \*\*\*\*\*-Available from Pentacore dealers only.

†Spacemaster Focal Lengths: 750mm to 1600mm with these cameras as follows: with 15x eyepiece — 750 to 960mm; 20x eyepiece — 1080 to 1320mm; 25x eyepiece — 1300 to 1600mm. All other cameras give Spacemaster range to 3000mm as follows: 15x eyepiece — 750 to 1500mm; 20x — 1500 to 2160mm; 25x — 2160 to 3000mm.

# Bushnell Microscopes for the Home Laboratory

• 20-year warranty

College and  
Medical Microscope,  
or Industrial  
Microscope,  
catalogue on request.



## Bushnell Models offer unparalleled values. Compare!

These are your answers for accurate, high precision microscopes to equip a home laboratory, or to encourage the progress of the junior scientist in your house. Bushnell microscopes are designed and tested for practicability and

excellence by Bushnell optical and mechanical engineers, in collaboration with actual users in the field. Bushnell microscopes have been pre-tested for eye-comfort and durability. Finished in baked grey enamel.



### Bushnell MODEL #90-5010

Top rating by consumer test group, this exceptional microscope is ideal for the secondary student and for the home laboratory. Unerring Bushnell quality with extra sturdiness and added features.

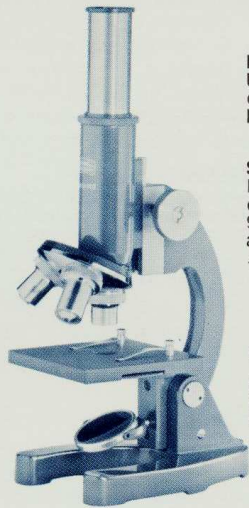
#### SPECIFICATIONS:

Rack-and-pinion focusing with adjustable tension dual control • 45° inclinable base • Triple objective turret Standard diameter eyepieces; objectives with Standard Society threads • Hard-coated optics • Stage drilled and tapped to accommodate mechanical stage accessory • Double substage mirror, plano-concave • Substage aperture control. Height, 10½"; Weight, 3 lb. 6 oz. Complete with dissecting kit, hardwood case and how to use booklet (see description below).  
#90-5010 **\$47.50**

#### POWER CHART

All optics included as shown. Figures inside boxes indicate total magnification.

		EYEPIECES	
		10x	15x
OBJECTIVES	4x	40x	60x
	10x	100x	150x
	40x	400x	600x



### Bushnell MODEL #90-5000

Unparalleled value for the beginning student, an accurate, high precision microscope which offers a full range of magnification at a new low price.

#### SPECIFICATIONS:

Rack-and-pinion focusing with dual control 45° inclinable base • Triple objective turret • Substage mirror • Substage aperture control. Height, 9"; Weight, 1 lb., 12 oz. Complete with dissecting kit, hardwood case, and how-to-use booklet (see description below).  
#90-5000 **\$29.50**

#### POWER CHART

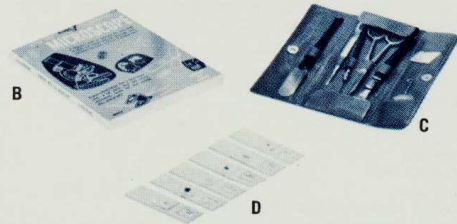
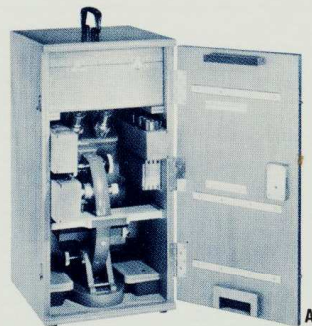
All optics included as shown. Figures inside boxes indicate total magnification.

		EYEPIECES	
		10x	15x
OBJECTIVES	8x	80x	120x
	20x	200x	300x
	40x	400x	600x



#### Microscope Illuminator

Built-in blue filter, adjustable for transmitted or reflected light; complete with 20-watt bulb.  
#91-0020 **\$4.50**  
(extra bulbs \$.35)



#### INCLUDED WITH EACH BUSHNELL HOME LABORATORY MICROSCOPE

**A. Hardwood Case:** Fitted carrying/storage cabinet of handsome, durable, fine-grain hardwood provides protection for the lifetime of your instrument.

**B. "Hunting with the Microscope",** an interesting and educational book, tells you how to use your microscope.

**C. Basic Dissecting Kit** consists of tweezers, knife, spatula, scissors, magnifier, and pins.

**D. Six prepared slides.**

## SKY CHIEF II

Bold adventure awaits you when you look through the Bushnell Sky Chief II telescope. Explore the earth and the universe beyond, travel across mountains and plains, far out to sea, into the starry night. A wide range of eyepieces (20mm, 12.5mm, 6mm, plus 2x Barlow lens) deliver from 45x to 304x magnification, drawing the most distant objects into intimate range, sparkling, life-like, breathtaking to behold! All lenses are hard-coated, fully color-corrected.

### SKY CHIEF II SPECIFICATIONS

**Objective Lens:** 60mm, achromatic, hard-coated, air-spaced. **Eyepieces:** K 20mm (45x magnification), HM 12.5 mm (73x magnification), HM 6mm (152 magnification). 2x Barlow Lens doubles power of each eyepiece. **Auxiliary Finder Telescope:** 6x, 30mm cross-wire reticle, fully adjustable. **Equatorial Mount:** Flexible cables for slow motion controls, easily positioned for use as altazimuth mount. **Additional Equipment:** Zenith Diagonal Prism for overhead viewing; moon and sun filters for safe solar observation; prism erecting system for terrestrial viewing; hardwood tripod, adjustable, fully-braced, with accessory tray. **Weight:** 38 lbs., including fitted hardwood carrying case.

#78-5300 Sky Chief II, only \$159.50 complete.

• 20 Year Warranty.



## SKY CHIEF JR.

The expanse of space invites conquest, and hunters of the sky will welcome the Sky Chief Jr. for its compactness and superb performance. The 20mm and 5mm eyepieces, plus a 2x Barlow lens, deliver from 35x to 280x magnification offering versatility that brings both the world around you and the world far beyond into sharp, brilliant finger-tip closeness. All lenses are hard-coated, fully color-corrected.

### SKY CHIEF JR. SPECIFICATIONS

**Objective Lens:** 60mm, achromatic, hard-coated, air-spaced. **Eyepieces:** R 20mm (35x magnification), SR 5mm (140x magnification). 2x Barlow Lens doubles power of each eyepiece. **Auxiliary Finder Telescope:** 5x, 20mm cross-wire reticle, fully adjustable. **Alt-Azimuth Mount:** Flexible cable for slow motion elevation control. **Additional Equipment:** Zenith Diagonal Prism for overhead viewing; sun filter for safe solar observation; prism erecting system for terrestrial viewing; hardwood tripod, adjustable, fully-braced, with accessory tray. **Weight:** 21 lbs., including fitted hardwood carrying case.

#78-5200 Sky Chief Jr., only \$89.50 complete.

20 Year Warranty.



## SKY ROVER

Versatile, yet simple to use, the sleek, streamlined Bushnell Sky Rover is the perfect family telescope. Its amazing Power Command gives the equivalent of eight individual eyepieces. With the flick of a finger you choose medium power, wide field magnification for nature study, satellite tracking, general observation . . . or instantly command reserve power for a close look at planets and stars. Complete portability makes it ideal for every viewing pleasure.

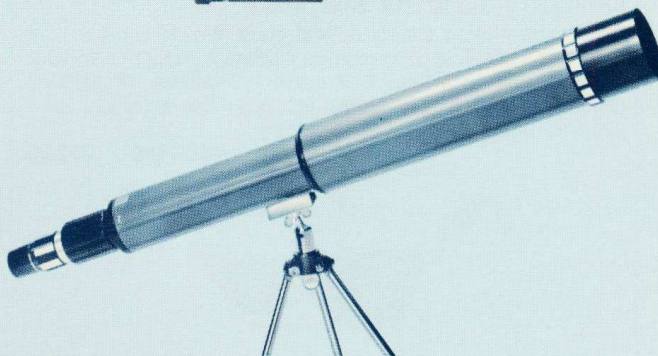
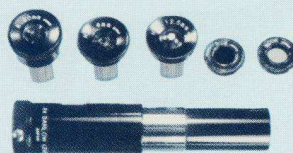
### SKY ROVER SPECIFICATIONS

**Objective Lens:** 50mm air-spaced, hard-coated achromat. **Eyepiece:** 22mm gives 25x to 60x magnification. **Auxiliary Finder:** Peep-sight type. **Alt-Azimuth Mount:** Variable tension, vertical and horizontal movements; with adjustable metal table-top tripod. **Dimensions:** 23½" closed; 30" extended; 3 lbs. 8 oz. Lightweight aluminum body, gray and blue baked enameloid finish.

#78-5100 Sky Rover, only \$49.50 complete.

20 Year Warranty.

# Astronomical Terrestrial Bushnell Telescopes



## ZOOM OBSERVER

Here's an ideal instrument for low-cost, year 'round entertainment. The Bushnell Zoom Observer. Its hard-coated, color-corrected optics produce a bright, clear picture that zooms from 16.5x to 50x magnification to give you a wide range of viewing excitement for astronomical and terrestrial use. It's exceptionally portable, too . . . a hardy traveling companion that can be tucked away in any spare corner of the car.

### ZOOM OBSERVER SPECIFICATIONS

**Objective Lens:** 50mm, hard-coated achromat. **Eyepiece:** Zoom, from 16.5x to 50x magnification. **Alt-Azimuth Mount:** Variable tension, vertical and horizontal movements; with removable 11" metal table tripod. **Dimensions:** 22½" focused at infinity; 2 lbs. 2 oz. Lightweight aluminum body, gray and blue baked enameloid finish.

#78-5000 Zoom Observer, only \$29.95 complete.

5 Year Warranty.

### TELESCOPE ACCESSORIES

CODE	DESCRIPTION	PRICE
78-5140	40mm eyepiece (Sky Rover and Sky Chief) .....	\$12.95
78-5112	12.5mm eyepiece (Sky Rover) .....	9.95
78-5101	Safety Solar Filter (for sun observation with Sky Rover) .....	1.75
78-5102	Zenith Diagonal Prism (Sky Rover) .....	8.95
78-5318	18mm eyepiece (Sky Chief) .....	12.95
78-5322	22mm eyepiece (Sky Chief) .....	9.95
78-5325	25mm eyepiece (Sky Chief) .....	14.95

# Bushnell Sunglasses

- **Finest Prescription-quality Lenses**
- **Scientific Protection for the Eye**
- **Accurate Color Vision**



## AIR FORCE STYLE SUNGLASSES

Gold plated wire frames, plastic tipped temples. Neutral gray, optically ground and polished prescription quality lenses. #80-1500 . . . \$5.98



## BUSHNELL SPORTVIEW SUNGLASSES

Finest prescription quality lenses, ground and polished to a distortion-free 6 base curve. Neutral gray lenses. Hand polished frames, wire core temples. #80-1100 . . . \$5.98



## CLIP-ON SUNGLASSES

Optically ground and polished lenses in neutral gray. Gold filled frame clips instantly to eyeglasses. Case included. Sizes: #80-1600, 48mm small lenses; #80-1601, 50mm medium lenses; #80-1602, 52mm large lenses. \$3.98



## CONVERTIBLE LENS SUNGLASSES

Two-in-one interchangeable yellow and gray plastic lenses housed in unbreakable nylon frame. Yellow for poor light and fog, gray for protection from the sun. Comfortably light with wraparound protection. #80-1400 . . . \$3.98

## UNCONDITIONALLY GUARANTEED AGAINST BREAKAGE

Lenses of these two models treated by a special heat process that hardens lenses to make them virtually unbreakable . . . a distinct advantage to the outdoorsman.



## BUSHNELL RANGEMASTER SUNGLASSES

Finest prescription quality optical glass, ground and polished to a wide angle 9 base curve gives maximum protection without a hint of the distortions that cause eye fatigue. Wraparound contour of neutral gray lenses protects from all sides. Hand polished frames, wire core temples. #80-1300 . . . \$12.95



## BUSHNELL CUSTOM SUNGLASSES

Finest prescription quality optical glass, ground and polished to a distortion-free 6 base curve. Neutral gray lenses. Hand polished frames, wire core temples. #80-1000 . . . \$7.98



## "SEE OVER READERS"

Magnifying half-frame reading glasses for those without astigmatism who simply need magnification for reading. Read detail with ease, yet retain normal vision over the top of the lenses. #80-2901 . . . \$5.98

For Shooting Glasses see page 18



**Bushnell**  
Bushnell Building  
Pasadena, California 91107

## National Police Testing Laboratories, Inc. Seal of Excellence

Awarded to Bushnell Binoculars, Rifle and Pistol Scopes, Spotting Scopes, Microscopes and Photo Optics. Bushnell is the first optical firm to receive this much coveted award from the National Police Testing Laboratories, a subsidiary of the National Police Officers Association of America.





