

OO

Bushnell '65...

**MB**

All that's  
new in  
sight...

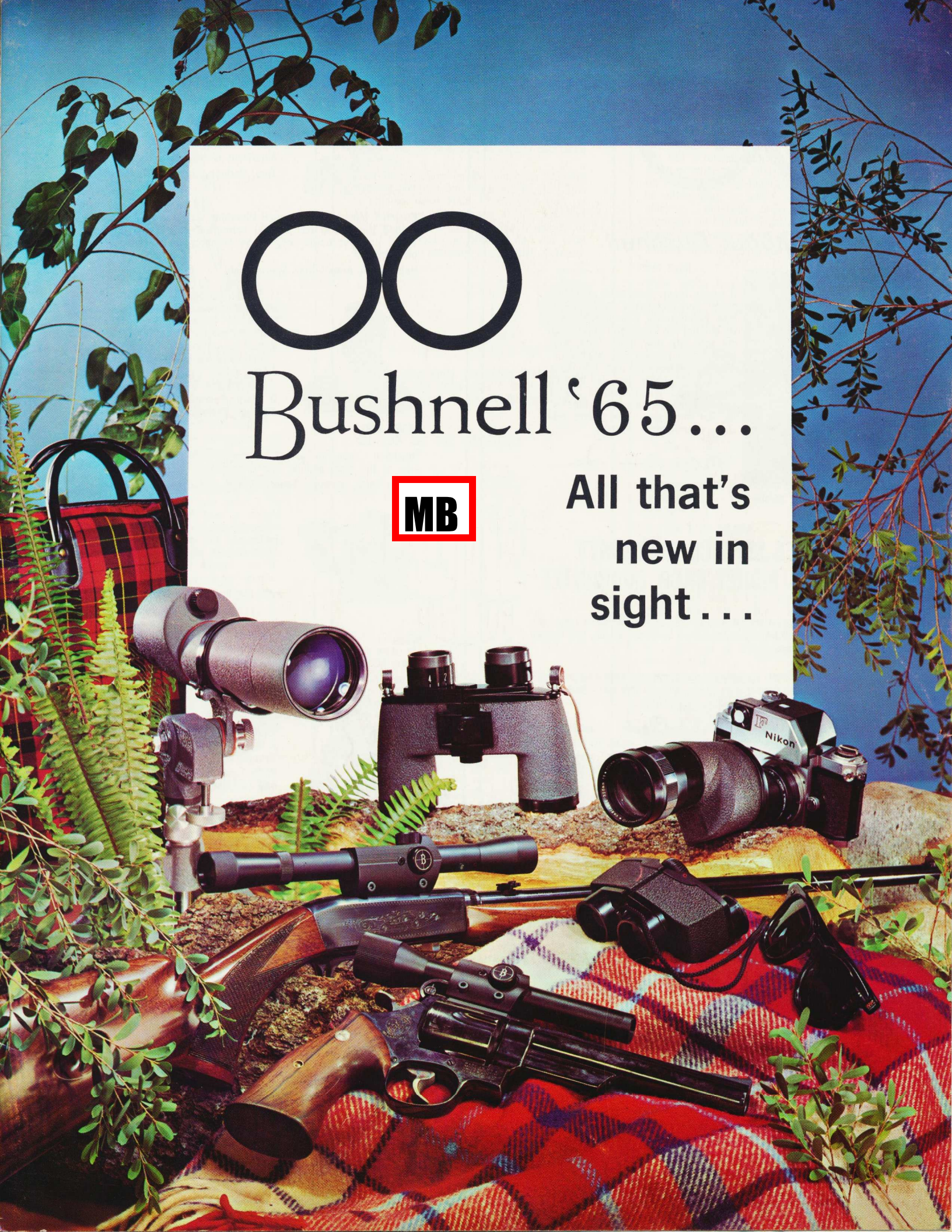

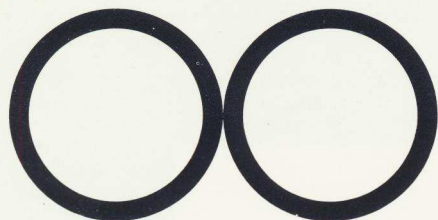

## A word about Bushnell



It's been many years since we introduced our first sport optics. Since then we've grown tremendously, yet we still get the same thrill in presenting you with new items (and, wait just as anxiously for your approval!). A lot of hard work has gone into these products . . . many prompted by your suggestions. We're excited about them and think you will be, too. Let us hear from you . . . we always welcome your letters.

*Dave Bushnell*

### FREE SERVICE WARRANTY 30-DAY MONEY-BACK GUARANTEE

1. All Bushnell optical products are high precision instruments of rugged construction. Each is fully tested and carries a free service warranty from Bushnell Optical Laboratory, Inc.
2. Bushnell instruments are warranted against defective materials and/or workmanship. Before shipping, each receives and must fully pass a series of tests covering essentials of optical and mechanical perfection.
3. The original Registered owner of a Bushnell instrument (except Banner and Sportview Brands) is entitled to free repair, free service, and free parts or replacement without charge for 20 years (Banner Brand for 5 years, Sportview for 1 year), provided instrument in our opinion shows no visible signs of having been dropped, maltreated, or disassembled.
4. If the instrument does not answer your purpose and is returned to the authorized seller in its original condition within 30 days after purchase, your money will be immediately refunded in full by the seller.
5. Should you require service, please pack your Bushnell instrument securely and enclose your report of unsatisfactory condition with your warranty card, stating when and from whom it was purchased. Mail it to us prepaid and insured. If you request it, an estimate of any charges will be sent you before work is done. Your instrument will be returned to you prepaid.



#### BUSHNELL OPTICAL LABORATORY, INC.

2828 East Foothill Blvd., Pasadena, California 91107  
In Canada: 1310 West Sixth Avenue, Vancouver 9, B.C.

Bushnell optical instruments are designed and tested for practicability and excellence by Bushnell optical and mechanical engineers, in collaboration with actual users in the field. For maximum economy, they are produced in Japan in factories selected for their uncompromising tradition of craftsmanship and pride in workmanship. Then, back in Bushnell laboratories, they are rigidly tested optically . . . mechanically . . . functionally. Only those instruments which measure up to the initial high standards are granted the Bushnell trademark.

## Experts who know praise Bushnell products



"Bushnell Binoculars give me the vision necessary to keep on top of the play or race . . . Bushnells are truly the All-Americans of the binocular field."

**Tom Harmon, Sports Director, ABC**

"Bushnell mount and Bushnell Phantom Scope work beautifully . . . I fired the XP100 out to 300 yards with the Bushnell Phantom Scope and got better long range accuracy than I have with any other pistol."

**Pete Brown, Arms Editor, Sports Afield**



" . . . during our recent Yeti expedition using Bushnell Binoculars and Viewing Scopes . . . we had not the slightest difficulty even in Rain Forest with condensation or moisture of any kind accumulating inside the instruments . . . the finest optical equipment that any expedition has ever had."

**R. Marlin Perkins, Director, St. Louis Zoological Gardens**

"Bushnell Command Post . . . a new revolutionary scope reticle . . . one of the most popular ever produced."

**Elmer Keith, Shooting Editor, Guns & Ammo**



"Your Spacemaster and other photo optic units are the most effective I've ever used with or without a camera. Pictures taken through these instruments astonish me."

**Erle Stanley Gardner, World Famous Author**

"ScopeChief 22, one of the neatest glass sights for .22 rimfires to come along in some time."

**Larry Koller, Supervising Editor, Guns and Hunting**



" . . . with a single shot blasted a bull moose . . . first time I ever hunted big game with a handgun . . . luck coupled with Bushnell ingenuity . . . that Phantom Scope!"

**Wally Taber, International Hunter and Lecturer**

" . . . the most versatile units around, the Bushnell Spacemaster and TeleVar."

**Herbert Keppler, Editor, Modern Photography**



"Good binoculars are an important aid to flying. Your Rangemasters are perfect. Plenty of magnification, wider field of view, and a most brilliant image."

**Donald W. Douglas, Sr., Douglas Aircraft Corporation**



"Have referred a good many inquiries to Bushnell because I like their optical quality, attractive finish, moderate prices. When I purchased a glass, I chose Bushnell over all others."

**Dr. Dinsmore Alter, Former Director, Griffith Observatory, Author, Lecturer, Scientist**

"Now at last a binocular has been designed that really is small and light enough to ride in a shirt pocket but also do the job of regular hunting glasses . . . Bushnell's new 6x25 Custom Compacts."

**Clare Conley, Managing Editor, Field and Stream**

# Look Here . . .

7x35? 8x30? 7x50?

**MB**

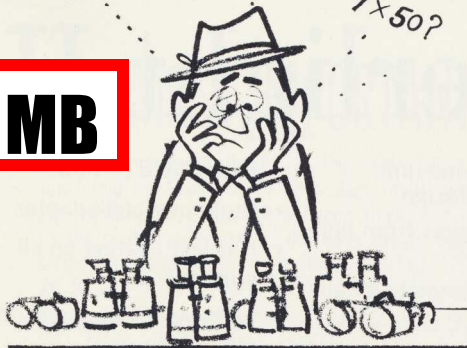

## Let's take the mystery out of binoculars

A fine binocular is a lifetime investment, one which pays you ceaseless dividends in enjoyment; asks nothing in return except the same care you give your other fine instruments. Selecting the binocular most suited to your needs is not a tricky "numbers game." The numbers are nothing more than a simple, practical guide to help you select binoculars more quickly and confidently. Our business is binoculars, so let us help you take the mystery out of them right now!

### DECODING . . . BY THE NUMBERS

Ever since Mr. Galileo made up the rules, the number preceding "x" (as in 7x, 35mm) has stood for **power of magnification** . . . meaning the binocular will bring an object that **many times closer** to the viewer; or make it appear that **many times larger** than it appears to the naked eye. Either definition is correct.

The number following "x" (such as 30, 35, 50, etc.) is simply the **diameter** of the front (objective) lens expressed in **millimeters**. This diameter is a factor in **light transmission** . . . a subject which is fully covered in the section titled, "Some Light Calculations."

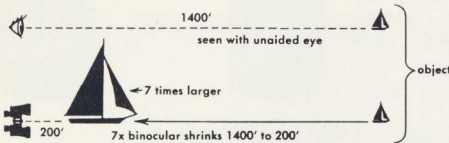

### DON'T BE 'OVERPOWERED'

As magnification increases, hand tremor becomes more noticeable . . . steady viewing more difficult. In fact, the most significant reason behind the all-time popularity of 7x, 35mm models is that — a **7 power glass offers the ideal magnification an average viewer can use without undue disturbance**. 6, 8 and 9 power binoculars are also considered standard, but above 9, prolonged viewing often requires something more substantial than hand-held support.

You can easily determine your most comfortable viewing, by looking at a detailed object through several different models. Be sure to allow for the effect of fatigue by holding each glass on target for two or three minutes.

### CONFUSED ABOUT FIELD OF VIEW —

Well, don't feel badly . . . it's one of those things that have been complicated out of proportion by well-meaning, if somewhat overzealous 'experts.'

Field of view is simply the diameter (width) of the picture seen at any given distance . . . it varies tremendously among binocular brands and models, and is usually expressed two ways —

Look for a figure on the binocular showing degrees and minutes; such as, 8° 45'. This is **angular field**. Field of view, in turn, is expressed in an absolute figure, such as 460 feet. This means you see a picture of 460 feet diameter at 1000 yards . . . 1000 yards being a standard comparative distance.

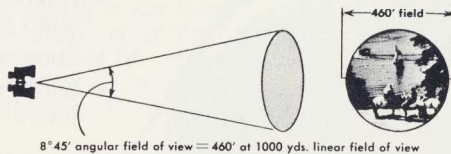

All else being equal, the widest field possible consistent with optical quality is highly desirable . . . especially for hunters and sports spectators.

### LOOK SHARP . . . YOU CAN SEE THE DIFFERENCE



In binocular optics, like camera optics, the capacity to retain detail and clarity is called **RESOLUTION** . . . or **DEFINITION**. Take two 7 power glasses, widely varied in price. Unless there's false labeling involved, both will bring an object **seven times closer** . . . but the difference in distinguishing fine detail can be shocking! You can see the difference yourself, by trying to read a magazine with a so-called bargain binocular from the maximum distance you can read the same page with a better brand.

And while we're on this subject, there's the matter of prolonged viewing. Better binoculars are built with your eyes in mind . . . they're critically sharp and optically balanced to deliver eye-saving comfort hour after hour. The person who says after a short look, "I can see all right with this lower priced binocular," runs the risk of experiencing some degree of eyestrain every time he puts them to extended use.

Remember, SUPERIOR OPTICS are one of the main ingredients of high quality binoculars!

### SOME LIGHT CALCULATIONS

A binocular's capacity to transmit light is dependent on three factors:  
1. Optical quality 2. Coating  
3. Size of exit pupil

#### Optical Quality

The importance of this factor is simply that the **BEST** optics deliver the **HIGHEST RESOLUTION** and eye-saving comfort . . . SUPERIOR optics are the main ingredient of high quality binoculars . . . and deliver the best picture . . . from every viewpoint!



### Coating

Most modern binoculars have some hard-coating; although often not enough. The purpose of hard-coating is to **reduce reflection**, and for best results it must be applied on **all** optical surfaces. A simple test of this is to catch the reflections of a white fluorescent tube in the objective end of the binocular, and again in the eyepiece. On both ends, you will see a reflected image of the tube from **each** external and internal optical surface. On a 100% coated binocular, **all** images will be either **blue** or **amber** (either is acceptable) . . . otherwise, every **white** image will represent an **UNCOATED** surface.

100% coating is standard procedure in the crafting of better binoculars.

### Exit Pupil

While you're looking, notice the bright disc of light emitted from the eyepieces. This is the exit pupil which transmits light to the eye. Its diameter is determined by **dividing the magnification of a binocular into its objective lens diameter** (for example, a 7x, 35mm binocular produces a 5mm exit pupil). For normal use, including **occasional** night viewing,

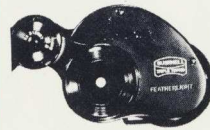

a 3.75mm (8x, 30mm = 3.75mm) or larger exit pupil will be sufficient. If night viewing is your dominant use, the 7x, 50 mm binocular offers a huge 7.1mm exit pupil, which corresponds to the widest opening of the human eye.

### BETTER BINOCULARS COST LESS TO OWN . . .

Because you pay for them only once! Any top-notch binocular will take hard knocks in stride . . . we mean the normal, day-to-day punishment that a less ruggedly constructed glass might not endure. The owner of a "bargain" binocular can easily spend many times its original value in repairs . . . and he'll still end up with something much less than the best.

### LIFETIME INVESTMENT

Think twice when you say to yourself, "I only use binoculars occasionally." 'Occasionally' adds up to hundreds, or even thousands of hours over a lifetime. With that much service in sight it pays you to take the time to select a binocular that will let you look forward to sparkling, comfortable vision that's built-in to **stay** . . . and do business with a company whose **service** is as dependable as its products.

### MORE THAN MEETS THE EYE

Even though you can actually **see** the big difference among binoculars, there's much more than meets the eye. For instance —

- Weight and handling comfort
- Construction detail
- Design specifications
- Precision of moving parts
- Carrying Case quality
- Guarantee policy



We think Bushnell's advertised 30-Day Trial-Exchange Privilege is an ironclad case in point. (Read the famous Bushnell Warranty thoroughly.)

Comparisons like this make a fine binocular look even better!

# New Bushnell Featherlight II

**MB**



- Exclusive mono-unit, sculptured design
- Brighter images from high index prisms
- Shock-proof construction
- Safety Vision, ultra-violet filters
- Wider field of view
- Built-in tripod adapter
- Hardest coating on all surfaces
- Lightweight magnesium alloy body

Handsome, side-opening fitted black case, handcrafted in America.



No engraving on top plate to distract eyes.



Carrying strap attaches on top binocular always hangs straight.

Distinctively engraved around lenses like fine cameras.

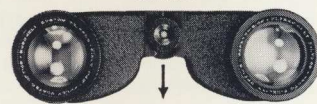

Tripod Adapter Socket



Tripod Adapter, \$3.95

## ALL PURPOSE 7x35 FEATHERLIGHT II

By far the world's most popular choice for hunting, sports, sightseeing . . . all around viewing . . . your first look through these new 7x35's will instantly reveal the crystal-clear difference between these and other brands. Ultraviolet filters protect against glare from snow, sand and water. Center focus only, **\$79.50\*** Field at 1000 yds.: 404'. Exit Pupil: 5mm. Height: 5½". Weight: 28 oz.

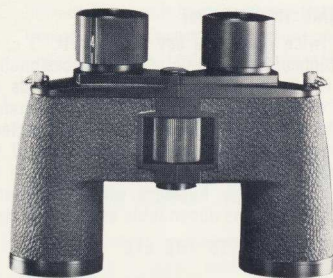

## 6x35 FEATHERLIGHT II

Handy, lightweight model for sports, hunting, and hiking. Extra brightness from full 35mm objectives and ultra-violet filters make it an excellent choice for the small boat owner. Center focus only, **\$69.50\*** Field at 1000 yds.: 404'. Exit Pupil: 5.8mm. Height 5¾". Weight: 28 oz.



## 8x35 FEATHERLIGHT II

Excellent daylight and twilight performance for all around use when traveling, hunting, viewing sports or in nature study.

Center focus only, **\$89.50\*** Field at 1000 yds.: 404'. Exit Pupil: 4.3mm. Height: 5⅝". Weight: 27 oz.



## 9x35 FEATHERLIGHT II

Excellent for advanced bird watchers and those who hunt in mountain country. Highest power recommended for hand-held use.

Center focus only, **\$89.50\*** Field at 1000 yds.: 404'. Exit Pupil: 3.9mm. Height 5½". Weight: 28 oz.

## 10x50 FEATHERLIGHT II

High-efficiency glass for day or at dusk. Ideal for hunters glassing at long distances, ornithology and other long distance viewing needs.

Center focus only, **\$110.00\*** Field at 1000 yds.: 368'. Exit Pupil: 5mm. Height 6⅞". Weight: 40 oz.

## 7x50 FEATHERLIGHT II

The extra high light transmission of this superior new 7x50 binocular makes it the outstanding choice for boat owners, night watchmen, and others who work under minimum light conditions . . . at night or in adverse weather. There's heft to these well balanced binoculars that men of action go for. Center focus only, **\$99.50\*** Field at 1000 yds.: 394'. Exit Pupil: 7.1mm. Height 7⅞". Weight: 40 oz.



## 7x35 W/A PANORAMIC RANGEMASTER

Unquestionably the finest wide angle binocular. Originally designed for sportscasters and big game hunters (professionals who need extra wide range and razor sharp definition), its ultra-modern contour body provides perfect balance for prolonged viewing comfort. 90% more viewing area than standard 7x35's. Exceptional clarity and brilliance. Unsurpassed choice for sports, spotting game, travel.

Center focus only, **\$135.00\*** Field at 1000 yds.: 578'. Exit pupil: 5mm. Height 4¾". Weight: 38 oz.

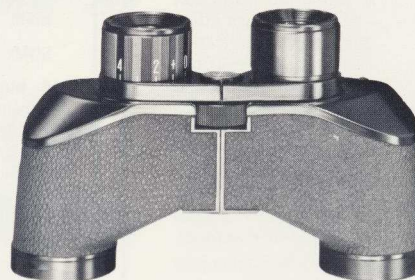

\*Plus usual 10% Federal Tax

# THE MOST IMPORTANT "NEW CONCEPT" IN BINOCULAR DESIGN IN 30-YEARS!

The new mono-unit design of the Featherlight II Binocular line is the most magnificent and functional improvement in binoculars in 30 years. Your first breathtaking look will reveal the big crystal-clear difference between these and ordinary binoculars. You even feel the difference as the sculptured curve of the body design balances effortlessly in your hands . . . in its satin-smooth adjustments . . . its flawless detail. High index prisms and full 35mm objectives in 6x, 7x, 8x and 9x give you brighter, sharper viewing than ever before. This is quality you can depend on . . . accurate, brilliant performance. Like the finest watch, the Featherlight II is constructed for "keeps," asking only reasonable care in exchange for a lifetime of trouble-free service.



## Custom Binoculars For eyeglass wearers

Top rated, award winning Custom Binoculars have achieved outstanding acclaim for the unique, special design of their optical system (not "just" retractable eyecups) that gives eye and non-eyeglass wearers the same full, brilliant field of view.

### WORLD FAMOUS 7x35 CUSTOM

Top rated by consumers, this superb all-purpose binocular has a unique optical system in combination with retractable eyecups that give the same full field of view with or without sun or eyeglasses. Ultraviolet filters protect against glare from snow, sand and water. Exceptional optics provide clear, brilliant viewing. Ideal for travel, vacations, spectator sports, hunting, nature study.

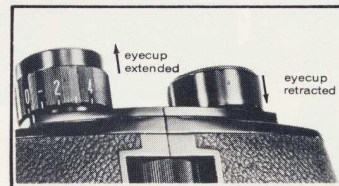

Center focus only, **\$89.50\***  
Field at 1000 yds.: 404'. Exit Pupil: 5mm. Height: 5". Weight: 23 oz.

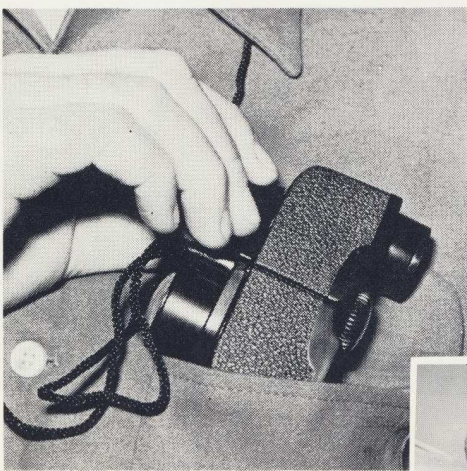

Slips easily in "his" shirt pocket for rugged hunting duty . . . or elegantly into "her" evening bag for theatre or opera.



## TINY 6x25 CUSTOM COMPACT — ONLY 3" HIGH

This little 3" high binocular is light to carry, fits easily in shirt or jacket pocket ready for instant use. That's not all, the weight is only 11 ounces — less than half the weight of most other 6x binoculars. Through its unique optical system and extendible eyecups it gives a full field of view with or without eye or sunglasses. Designed for hunters, it is sturdy as a work mule, yet handsome enough to carry to the theatre. Comes complete with a zippered carrying case.

Center focus only, **\$59.50\***

Field at 1000 yds.: 420'. Exit Pupil: 4.22mm. Height 3 1/8". Weight: 11 oz.



**YOUR VERY FINEST VALUE IN  
ECONOMY-PRICED  
QUALITY**



- Brilliant 100% hard coated optics
- Fast center focusing
- Popular American style
- Exclusive side-opening case



**Banner 7 x 35** Shipping weight: 3 lbs. 3 oz. **\$39.50**  
All-purpose favorite 7x35's have long been the overwhelming choice of hunters, sportsmen, experts in many fields. Perfect, too, for anyone who enjoys a variety of viewing pleasures. With its compact size, 7 power magnification and high light transmission, the Bushnell 7x35 Banner is ideally suited to those who want an accurate, dependable, all-purpose binocular at a budget-minded price.

Field of View: 378' @ 1000 yds. • Exit Pupil: 5mm • Height: 5 1/4"  
Weight: 21 oz.

**Banner 6 x 30** Shipping weight: 3 lbs. **\$34.50**

**Banner 7 x 50** Shipping weight: 4 lbs. 8 oz. **\$49.50**

Field of View: 375' • Exit Pupil: 7.1mm • Height: 7 1/16" • Weight: 36 oz.



**Banner 7 x 35 Wide-Angle** Shipping weight: 3 lbs. 12 oz. **\$69.50**

First introduced by Bushnell, the wide-angle 7x35 has become standard equipment for sportscasters and others who must cover big chunks of territory fast and accurately. Like its world-famous counterpart, the Bushnell Rangemaster, this new Banner actually delivers 90% more area of sight than ordinary 7x35's! For big, bright, crystal-clear viewing, nothing in its price range can touch the wide-angle Banner.

Field of View: 577' • Exit Pupil: 5mm • Height 5' • Weight: 32 oz.



**Banner 7 x 12 x 40 Zoom** Shipping weight: 3 lbs. 14 oz. **\$79.50**

Zoom in from all-purpose 7-power to close-up 12-power without changing focus! There's no visual distortion as you pinpoint the action of a touchdown pass or a finish line. Perfect for hunting and nature study, too. Find your game at 7x, then zoom in to study it at 12x. Terrific value in an economy priced zoom binocular.

Field of View: 328-300' • Exit Pupil @ 7x: 5.2mm • Height: 6 1/2"  
Weight: 41 oz.

\*Plus usual 10% Federal tax.

# Bushnell **SPORTVIEW BINOCULARS**

**GOOD, CLEAR, DEPENDABLE  
QUALITY EVEN ON A  
LIMITED BUDGET**



- Coated Lenses and Prisms
- Exclusive Case Design

## **SPORTVIEW 7x35**

**\$29.50**

Shipping weight: 2 lbs. 4 oz.

Best choice for all-purpose viewing for every situation: hunting, sports events, nature study, vacationing. Traditional two-piece body styling; fast, convenient center focusing, plus individual right eye adjustment. Coated lenses and prisms. Complete with carrying case and straps.

Field of View: 341' @ 1000 yds. • Exit Pupil: 5mm • Height: 5 $\frac{5}{8}$ " • Weight: 22 oz.



## **SPORTVIEW 7x35 WIDE ANGLE**

**\$49.50**

Shipping weight: 3 lbs. 4 oz.

Extra-wide field, tops for sports events, spotting game. Fast, convenient center focusing, plus individual right eye adjustment. Coated lenses and prisms. Complete with carrying case and straps.

Field of View: 578' • Exit Pupil: 5mm • Height: 4 $\frac{1}{2}$ " • Weight: 30 oz.



## **SPORTVIEW 7x50**

**\$39.50**

Shipping weight: 3 lbs. 8 oz.

High light gathering power, best selection for boating, at night, or in adverse weather. Traditional two-piece body styling; fast, convenient center focusing, plus individual right eye adjustment. Coated lenses and prisms. Complete with carrying case and straps.

Field of View: 376' • Exit Pupil: 7.1mm • Height: 6 $\frac{7}{8}$ " • Weight: 36 oz.



6x30	Shipping weight: 2 lbs.	<b>\$27.50</b>	8x30	Shipping weight: 2 lbs.	<b>\$29.50</b>
Center focus, two-piece body. • Field of View: 394' • Exit Pupil: 3.8mm • Height: 4 $\frac{1}{2}$ " • Weight: 18 oz.			Center focus, two-piece body. • Field of View: 394' • Exit Pupil: 5mm • Height: 4 $\frac{5}{8}$ " • Weight: 20 oz.		

\*Plus usual 10% Federal tax.

• finest prescription quality lenses • accurate color vision

# Bushnell Sunglasses

Scientific eye protection for the outdoorsman

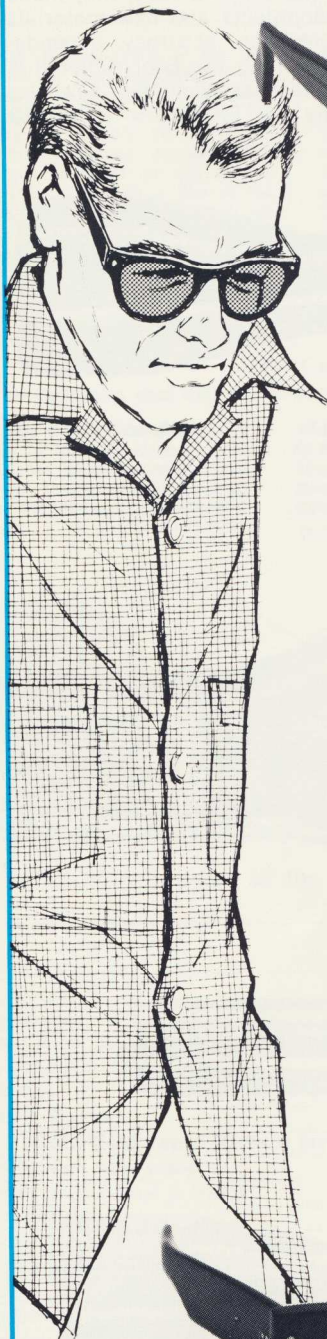

(Slim-Line temple)

## Bushnell Sportview Sunglasses \$6.95

Finest optical glass, ground and polished to six-base curve. Neutral gray lens. Plastic, comfort fit frame.

- SG5A Slim-Line temple, Honey Amber frame
- SG5B Slim-Line temple, Black frame
- SG6A Wide temple, Honey Amber frame
- SG6B Wide temple, Black frame



(Wide temple)

## Bushnell Sportsman Sunglasses

Break-Resistant Lenses

\$9.95

Finest prescription quality optical glass ground and polished to six-base curve. Break-Resistant, a special heat process, gives the lenses many times the strength of ordinary sun glasses . . . and assures the image projected is free from any distortions that could cause eyestrain. Neutral gray lenses. Lightweight plastic frames are handsomely styled for excellent fit.

- SG2A Contour temple, Honey Amber frame
- SG2B Contour temple, Black frame
- SG3A Slim-Line temple, Honey Amber frame
- SG3B Slim-Line temple, Black frame
- SG4B Wide temple, Black frame
- SG4G Wide temple, Gray Smoke frame



(Contour temple)

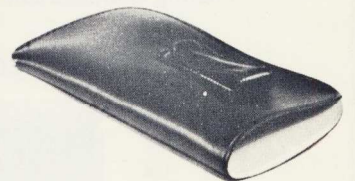

- 9-Base Curve
- Break-Resistant Lenses
- Wide Angle Lenses



(Wide-Angle lenses)

## Bushnell Rangemaster Sunglasses \$12.95

The ultimate in features and quality. Finest prescription quality optical glass, ground and polished to a 9-base curve, assure eyes maximum protection from imperfections and distortions that can cause fatigue. Break-Resistant, a special heat process case hardens lenses to give them many times the strength of ordinary optical glass lenses and produces greater resistance to shattering . . . a distinct advantage for active outdoorsmen. Neutral gray, wide-angle lenses wrap around eyes to protect them from all directions . . . Lightweight, hand-made frames of specially treated plastic and fitted bridge assure greatest strength and perfect fit.

- SG1A Wide-angle lenses, Honey Amber frame
- SG1B Wide-angle lenses, Black frame



**The  
new**

You have never sighted through a riflescope like this before . . . because there has never been one like it.

The ScopeChief II is an entirely new optical concept in riflescopes, with more important new features for successful hunting than ever before available in any riflescope.



# Bushnell ScopeChief II

Bushnell optical engineers, hunters themselves, realize many times a whole year of plans and dreams is culminated in a single decisive shot. That shot just has to be good. In the Scope-Chief II they made full use of the advance in optical developments and new materials at their command. In precision, accuracy, dependability, versatility, brilliance . . . the ScopeChief II is clearly superior to any riflescope available anywhere, at any price . . . truly an EXPERT'S HUNTING RIFLESCOPE.

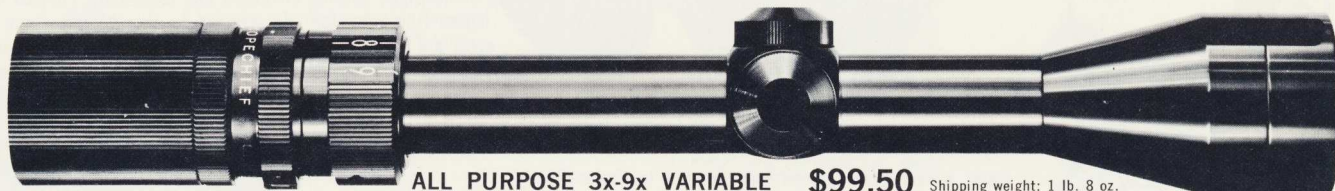

ALL PURPOSE 3x-9x VARIABLE \$99.50 Shipping weight: 1 lb. 8 oz.

All Purpose 3x-9x Variable with exclusive "Magnetic" Command Post proved most effective reticle for all hunting.

Here, without reservation, is the finest, most versatile precision optical instrument on the riflescope market today. This is the scope designed for the expert . . . the hunter who thrills to the joy of owning and using the best equipment money can buy. The serious hunter, who knows the success of his hunt depends on the perfection he demands in his equipment. Designed entirely without compromises, every specification reflects the quality optical engineering characteristic of all Bushnell products.

**Air Spaced Lenses** for photographic clarity; flat distortion-free field even at critical high powers.

**14 Precision Ground Optical Elements** every surface hard coated for greater luminosity in dimly lit brush, at dawn or dusk.

**Rugged Hard Anodized Finish** on streamlined 1" tube — virtually mar and scratch proof.

**Prismatic Optical Principle** makes windage and elevation adjustments prismatically by bending light rays for hair-splitting accuracy and assuring retention of point of impact.

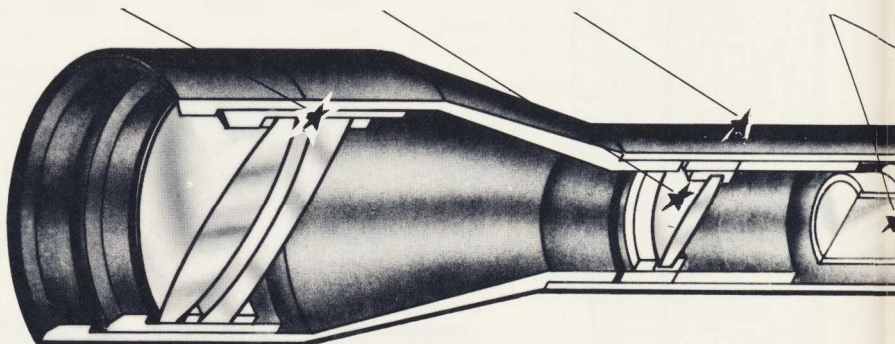

## BUSHNELL ScopeChief II Fixed Power Scopes

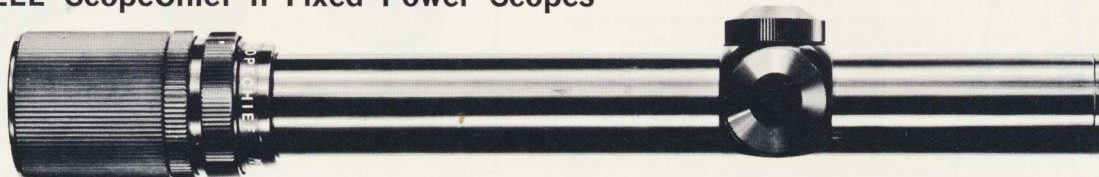

2 3/4x Magnetic Command Post, preferred power and reticle choice for fast, accurate sighting on big game at short ranges in brush or wooded areas. \$49.50

Shipping weight: 1 lb. 1 oz.

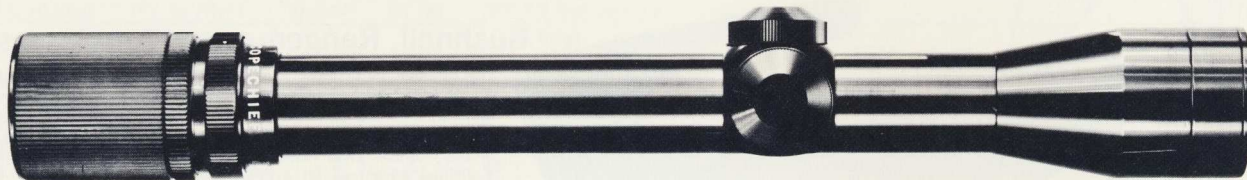

4x Magnetic Command Post, choice of the serious hunter for big game in open country at dawn, mid-day or dusk. \$59.50 Shipping weight: 1 lb. 2 oz.

**Magnetic Command Post** gives you two reticles at fingertip command in one scope. Generous eye relief for maximum comfort and safety; wide field of view; all optics hard coated to give you superb luminosity and needle-sharp viewing edge-to-edge. The scope that spotlights game even in dimly lit areas. Fog proof; virtually scratch and mar proof hard anodized finish.

The unique ScopeChief II fixed power scopes provide more new advantages for successful hunting than any other fixed power scopes available. Prismatic windage and elevation adjustments for unequalled dead on accuracy and positive retention of point of impact. Reticle always permanently centered.

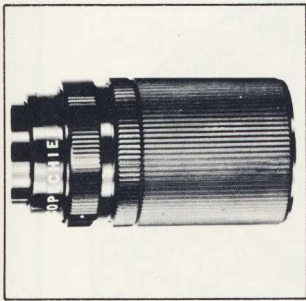

Magnetic remote control of two separate reticles. Make split second reticle changes from shooting position even while sighting on trophy game! The amazing new magnetic remote control ring for the famous Command Post gives you crosshairs for well lighted, open country, or with a flick of the fingers, a post flips up instantly for brush, dawn, or dusk. Command Post, proved most effective reticle for all hunting, gives you at least **40 minutes more hunting time each day.**

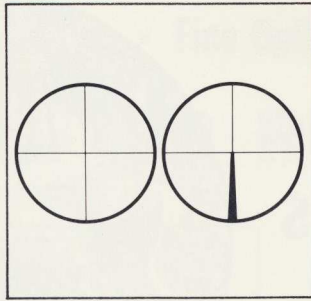

Reticle always remains centered and same size. Both reticles in the new ScopeChief II are always permanently centered for quick, accurate aiming. In the Variable, the reticle appears the same size through every power change, making it ideal for every hunting situation . . . from varmint to big game. Brilliantly engineered, with long eye relief and extra field of view, you'll never be troubled with internal fog, moisture or dust. Built to take rugged duty, the Rhino-coat finish of the new ScopeChief II is virtually mar and scratch proof.

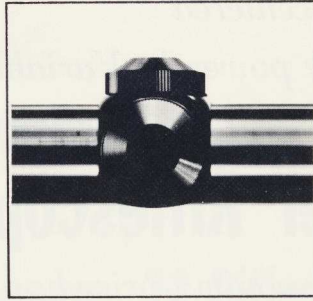

Prismatic precision; unequalled adjustment accuracy. World's only prismatic adjustable riflescope, the revolutionary new principle that optically bends light rays making windage and elevation adjustments prismatically with hair-splitting accuracy and assuring positive retention of point of impact. When hunting a variety of game in vast, rugged areas, or anywhere else, you can accurately change point of impact for each bullet weight and return to exact zero every time.

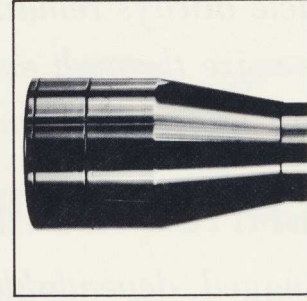

Air spaced lenses; 14 optical elements in Variable 3x-9x. Air spaced objective lenses, time-proven in expensive precision cameras, are now a major advance in riflescope optical systems. This makes possible finest visual corrections and a field of view, needle sharp, flat and distortion free edge to edge, even at the more critical high powers. The Variable has 14 precision ground optical elements, **three more than other popular variables**, with every surface hard coated for greater luminosity, allowing you to hunt earlier in the morning and well into twilight.

Here are the features which make the new Bushnell 3x-9x ScopeChief II the **ONLY** choice for all around hunting:

Sealed for complete protection from all weather conditions. Trouble free from internal fog, moisture or dust.

Power Selection Ring smoothly takes you from 3x to 9x with sight picture constantly in focus; reticles positioned so they will not magnify as power increases.

Magnetic Command Post Control Ring for split second fingertip choice of two separate reticles . . . gives you 40 minutes more hunting time each day.

Reticles permanently centered, no matter how many times you switch from one to the other; **will not magnify** as power is increased.

Generous Eye Relief for maximum safety; **Extra Wide Field** for ease in following moving game.

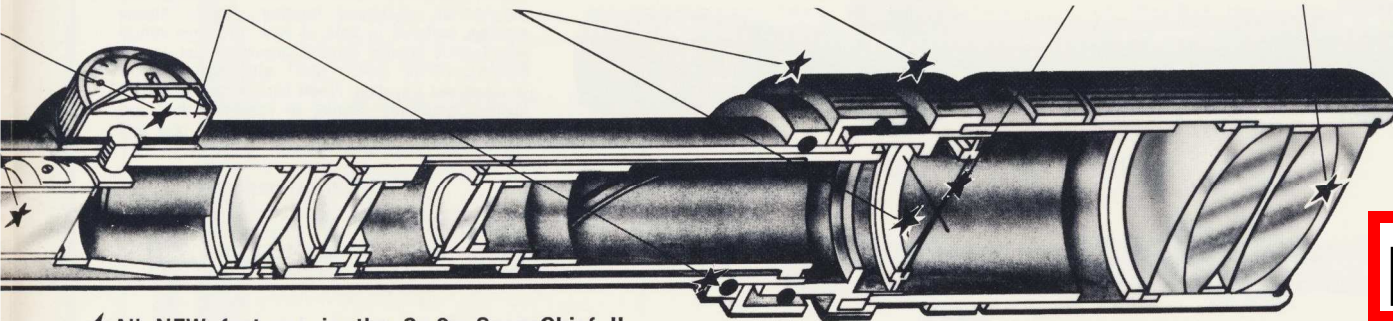

★ All NEW features in the 3x-9x ScopeChief II

### Bushnell ScopeChief II Specifications

	3x-9x Variable with Exclusive Magnetic Command Post							Fixed Power Scopes	
	3x	4x	5x	6x	7x	8x	9x	2.75x	4x
Magnification	3x	4x	5x	6x	7x	8x	9x	2.75x	4x
Actual Magnification	3.01x	4.01x	5.00x	6.00x	7.00x	8.00x	8.99x	2.7x	4x
Clear Aperture of Objective Lens	38mm	38mm	38mm	38mm	38mm	38mm	38mm	21mm	32mm
Exit Pupil	12.54mm	9.47mm	7.6mm	6.33mm	5.43mm	4.75mm	4.22mm	7.64mm	8mm
Relative Brightness	157	90	58	40	29.5	22.5	18	58.4	64
Field of View @ 100 Yards	39'	31.5'	23'	21.5'	18'	15'	13'	43.5'	30'
Eye Relief	3½"	3½"	3½"	3½"	3½"	3½"	3½"	3½"	3½"
Overall Length Focused to Infinity	12 5/8"	12 5/8"	12 5/8"	12 5/8"	12 5/8"	12 5/8"	12 5/8"	10 5/8"	11 7/8"
Tube Diameter	1"	1"	1"	1"	1"	1"	1"	1"	1"
Outside Diameter at Objective End	1.77"	1.77"	1.77"	1.77"	1.77"	1.77"	1.77"	1"	1.5"
Outside Diameter at Eyepiece End	1.57"	1.57"	1.57"	1.57"	1.57"	1.57"	1.57"	1.438"	1.438"
Weight	15 oz.	15 oz.	15 oz.	15 oz.	15 oz.	15 oz.	15 oz.	9½ oz.	10½ oz.
Graduation of Internal Click Adjustment @ 100 Yards	¼"	¼"	¼"	¼"	¼"	¼"	¼"	¼"	¼"
Crosshair Reticle Subtends @ 100 Yards	1"	.75"	.6"	.5"	.43"	.375"	.33"	1.2"	0.84"
Command Post Subtends @ 100 Yards	4"	3"	2.4"	2"	1.72"	1.5"	1.3"	5"	3.5"

Mounts — Can be mounted with any standard height 1" Ring (on most rifles) • Finish — Hard Anodized — unscratchable from normal use  
 All scopes produced to Bushnell specifications in Japan's finest optical factories for maximum economy.

- 729 2.75x ScopeChief II with Command Post **\$49.50**
- 749 4x ScopeChief II with Command Post **59.50**
- 799 3x-9x ScopeChief II Variable with Command Post **99.50**



- Reticle always remains centered
- Same size through every power in Variable
- Finest hardcoated lenses • Precise adjustments

# Bushnell Banner Riflescopes

*Rugged, dependable, economy-priced . . .*

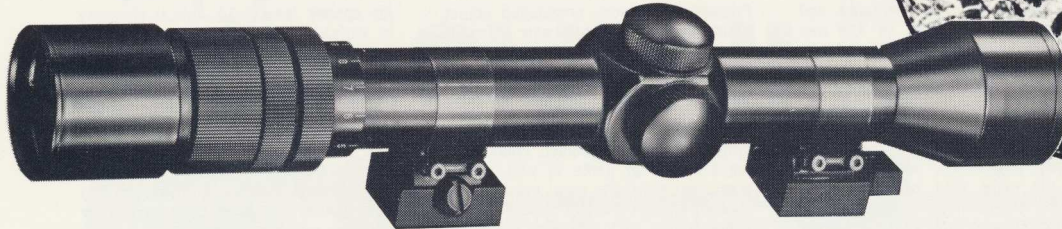
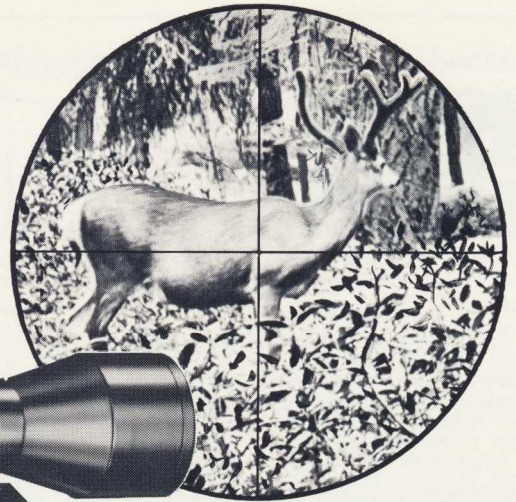

## NEW 3x-9x BANNER VARIABLE \$49.50

### 3x-9x SPECIFICATIONS

Overall Length 11 3/8"; Eye Relief 3"-3 1/2"; Weight 13 1/2 oz.; Clear Aperture of Obj. Lens 32mm.

Eye-piece Magnification	3x	4x	5x	6x	7x	8x	9x
Field at 100 yds.	39'	28'	22'	19'	16'	14'	13'
Diam. of Exit Pupil	10.7mm	8mm	6.4mm	5.3mm	4.6mm	4mm	3.6mm

Shipping weight: 1 lb. 4 oz.

. . . at last a budget-priced Variable

Designed for the hunter who has dreamed of combining optical precision and versatile magnification with a budget price. Reticle **always remains centered** in field of view, and same size as you zoom from 3x to 9x. Maintains constant, sharp sighting image through every power change by use of two precision cams. Finest hard-coated lenses for highest luminosity. Precise reticle adjustments for windage and elevation. Sealed to keep out dust and moisture.

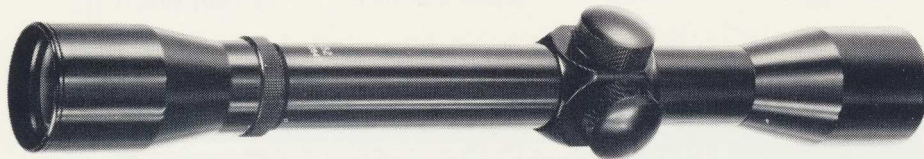

## BANNER 4x, \$37.50

Shipping weight: 1 lb. 2 oz.



. . . a full-size, standard 1"

Popular, economy-priced 4x rifle scope, tough and rugged for all-around hunting. Reticle **always remains centered** in field of view. Precision reticle adjustments provide extreme accuracy. Dial can be repositioned to exact "zero" after adjusting for windage and elevation. Finest hard-coated lenses for highest luminosity. Sealed to keep out dust and moisture. 4x available with crosshairs or post and crosshair. (2.5x crosshair only.)

### 4x SPECIFICATIONS

Overall Length 11.75"; Weight 9 oz.; Eyepiece Diam. 1.42"; Eye Relief 3.5" - 5"; Objective Diam. 1.50"; Objective Lens 1.26"; Exit Pupil 8mm (.315"); Field at 100 Yds. 30'; Tube Diam. 1".

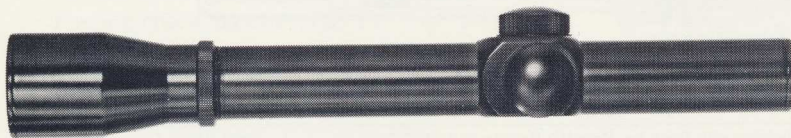

## BANNER 2.5x, \$29.50

Shipping weight: 1 lb. 1 oz.

### BUSHNELL BANNER SCOPES - ACCESSORIES

Code	Model	Price
728	2 1/2x with Medium Crosshairs	\$29.50
748	4x with Medium Crosshairs	37.50
738	4x with Post	37.50
798	3x-9x Variable with Medium Crosshairs	49.50
705B	2 1/2x Leather Lens Caps, pr.	2.00
706B	4x Leather Lens Caps, pr.	2.00
709	3x-9x Leather Lens Caps, pr.	2.00

### BUSHNELL RIFLESCOPE MOUNTS with windage adjustment

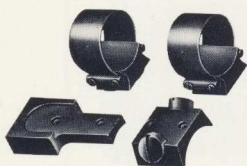

1"—LOK-BAND  
rings with  
QUICK-MOUNT bases,  
\$12.50 set

#### BUSHNELL Mounts fit these rifles:

- #817 Mauser FN, Higgins 51, Marlin 455, Husqvarna and Browning except ring actions)
- #818 Mauser 98
- #820 Remington 721, 722, 725 (long & short), Weatherby Mark V
- #823 Remington 740, 760 and 742
- #831 Winchester 70 (except .300 & 375 H & H)
- #833 Winchester 88, 100

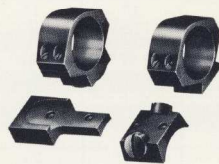

1"—STANDARD  
split rings with  
QUICK-MOUNT bases,  
\$12.50 set

### Protect Your Rifle Scope With Bushnell Lens Caps

Rifle scope lens caps protect optical surfaces of your rifle scope by keeping dust, dirt, and moisture off the lenses while in the field or out of use.

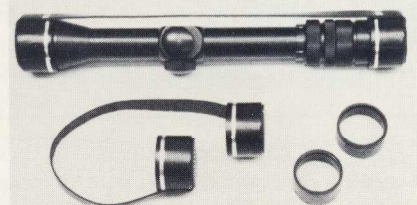

▪ Dependable Quality ▪ Fine Optics



# Bushnell .22 Riflescopes

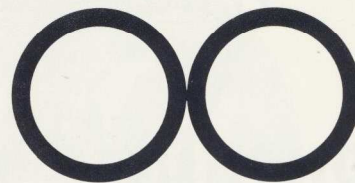

## *Bushnell* ScopeChief 22

the royalty of .22 riflescopes, with exclusive† one-piece turret/mount only \$19.95

The ScopeChief 22 is not only perfect when new, but built to such exacting engineering tolerances, the same top performance is assured through year after year of use in the field.

Ultra fine, precision micrometer windage and elevation adjustments assure unfailing accuracy for the most critical sighting, since fractions of a minute can be dialed. Unusually large objective and eyepiece lenses give greater brightness, allow fast, easy positioning of the eye.

Reticle mechanism designed so that under normal shooting conditions crosshairs always appear centered.

A full 30.5 foot field of view, rapier sharp from edge to edge, makes it easy to follow running game, or reach out and take game you'd miss with ordinary sights. Lenses have deep sunshades to prevent glare; are coated with Bushnell's superior low reflection, hard coating for highest luminosity. Sealed to keep out moisture and fog.

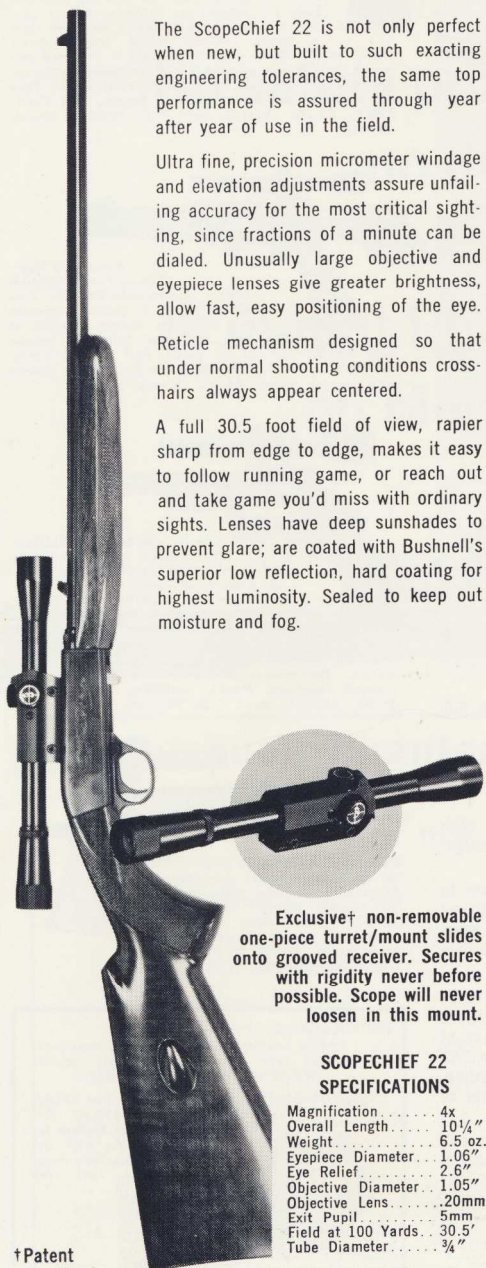

Exclusive† non-removable one-piece turret/mount slides onto grooved receiver. Secures with rigidity never before possible. Scope will never loosen in this mount.

### SCOPECHIEF 22 SPECIFICATIONS

Magnification . . . . . 4x  
Overall Length . . . . . 10 1/4"  
Weight . . . . . 6.5 oz.  
Eyepiece Diameter . . . . . 1.06"  
Eye Relief . . . . . 2.6"  
Objective Diameter . . . . . 1.05"  
Objective Lens . . . . . 20mm  
Exit Pupil . . . . . 5mm  
Field at 100 Yards . . . . . 30.5'  
Tube Diameter . . . . . 3/4"

†Patent Pending

## Banner .22 Riflescopes . . .

An economy-priced companion line to the famous ScopeChief. Rugged and durable with features you expect only in riflescopes costing much more, the Banner line has been crafted with the precision and inner quality you naturally expect in a Bushnell instrument. Precise reticle adjustments for windage and elevation. Finest quality lenses hard-coated for highest luminosity. Sealed to keep out dust and moisture.

**NEW 3x-7x BANNER 22, \$19.95** (mount included)

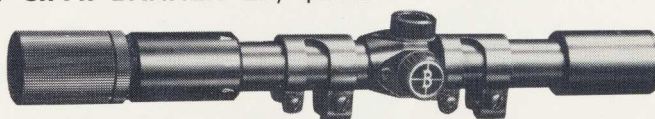

. . . a high-quality, precision variable for .22 rifles

Provides a full range of magnifying powers for .22 rifles, from 3x through 7x. Ideal for hunting situations from small game to plinking at tin cans. Finest quality optics with constant, brilliant, sharp sighting through every power change. Complete with versatile two-piece mount.

### SPECIFICATIONS

Overall Length 10 1/4"; Weight 7 oz.; Clear Aperture of Objective Lens 21mm; Eyepiece Diam. 1.07mm; Outside Diam. of Objective 1"; Diam. of Tube 3/4"; Eye Relief 2" - 3 1/2".

Eyepiece Mag.	3x	4x	5x	6x	7x
Field at 100 yds.	32'	29'	23'	19'	17.75'
Diam. of Exit Pupil	7mm	5.25mm	4.2mm	3.5mm	3mm

**4x BANNER 22, \$14.95** (mount included)



. . . an inexpensive all-around scope for .22 rifles

Provides a wide field; brilliant, sharp optics; lightweight aluminum alloy tube. Precise micrometer screw type windage and elevation adjustments. Large objective and eyepiece lenses, give great brightness, allow easy positioning of the eye. Deep sunshades eliminate reflections. Crosshair only.

### SPECIFICATIONS

Magnification 4x; Overall Length 10 1/4"; Weight with Mount 7 oz.; Eyepiece Diam. 1.06"; Eye Relief 2.3"; Objective Diam. 1.05"; Objective Lens 20mm; Exit Pupil 5mm; Field at 100 Yds. 30'; Tube Diam. 3/4".

New . . . Good, Dependable Quality

## 4x Sportview 22 Riflescope, \$9.75



For those on a limited budget, here is a good, rugged teammate for dependable performance in the field on rimfire rifles. Brightens and enlarges target, increases accuracy at any range. Precise windage and elevation adjustments. Hard-coated lenses. Sealed to keep out dust and moisture. (mount included)

# What did the experts say?\*

\*"Unquestionably, the Phantom increases potential of any revolver"  
 "... doubles normal shooting range"  
 "... puts iron sights to shame when it comes to accuracy ..."

## BUSHNELL PHANTOM SCOPE

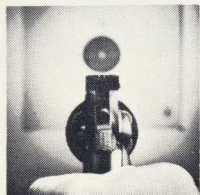

WITH IRON SIGHTS



WITH PHANTOM

- 1.3X PHANTOM (all-purpose, game and target)..... \$24.50  
Shipping weight 12 oz.
- 2.6X PHANTOM (varmint and long range)..... \$34.50  
Shipping weight 15 oz.

### Why Scope a Pistol?

No human eye can focus on both iron sights and target at the same time. With the Phantom, crosshair and target are one razor-sharp image that remains bright and clear even when lighting is poor.

The handgun with iron sights is without question the most difficult firearm to master. Since distance between sights is so short, small sighting errors cause dismal failure at the target. This problem of keeping both front and rear sights in exact alignment, with the target a fuzzy blur in the background, has kept many shooters with years of experience shooting low scores.

### Phantom Eliminates Sighting Problems

The Phantom gives perfect clarity of sight picture and permits extremely accurate holding on the target, because the crosshair and target are on the same plane of vision. This single sighting plane plus micrometer reticle adjustments give precision not possible with iron sights. Target remains sharp and clear even with poor lighting. Also, the crosshair reticle in the Phantom always remains centered in the field of view. This is especially valuable because of the lower velocity of handguns.

The Phantom, designed specifically for handguns, has an eye relief of 6" to 21" which takes you easily from "two hand" varmint to "arm's length" target position. All optics are hard coated to give greater luminosity.

### SPECIFICATIONS FOR PHANTOM SCOPE

Magnification	1.3x	2.6x	Magnification	1.3x	2.6x
Weight	5 1/4 oz.	5 3/4 oz.	Objective Diameter	.750"	.750"
Length	7 1/2"	8 3/8"	Objective Lens Diameter	15mm	15mm
Eye-piece Diameter	1.2"	1.2"	Exit Pupil	11.5mm	5.8mm
Eye Relief	6"-21"	7"-17"	Field at 100 yards	17'	8.5'

National Police Testing Laboratories, Inc.  
Seal of Excellence



Awarded to Bushnell Binoculars, Rifle and Pistol Scopes, Spotting Scopes, Microscopes and Photo Optics, Bushnell is the first optical firm to receive this much coveted award from the National Police Testing Laboratories, a subsidiary of the National Police Officers Association of America.



**Rigid Top Mounts Secure Phantom Even with Heaviest Loads**  
The Phantom will give you greater handgun accuracy and at longer distances than you realized possible.

Rigid Top Mounts are recommended as your best all around mount choice for either light or heavy calibers. Rigid Mounts screw firmly to top strap when rear sight is removed and secure the Phantom so that it will not budge or change point of impact even with the heaviest loads. They are available for most S&W's, Rugers, and Colts. Mount, \$5.00. (Specify gun) 1.3x Phantom recommended.



**Mounts for High-Velocity Pistols Varmint**

pistols scoped with the new 2.6x Phantom pack a deadly, accurate wallop that can tumble coyotes at 200 yards, or more. Field test groups with XP100: 1/4" at 50 yards, 3/4" at 100 yards. XP100 and .256 Ruger Hawkeye are factory drilled and tapped. Mount, \$5.00. (Specify gun)



**Clip Mounts for Light Calibers**

Clip mounts, for use when only light loads will be fired, or with recoil anchor installed, for use on guns for which Rigid Top Mounts are not available. Clip Mount snaps over top strap. Requires no drilling or tapping. Iron sights remain. Available for most S&W and Colt revolvers, Ruger Single Six and center fire models. No mounts necessary for .22 rifles with grooved receivers. Mount, including recoil anchor, \$5.00. (Specify gun) 1.3x Phantom recommended.



**Mount for Autoloaders** Popular Colt Autoloaders with the Phantom come into their own for hunting varmint and small game. Ingenious new mount replaces left grip in minutes, using the same screws. Mount, \$9.95. 1.3x Phantom recommended.

### Holsters

**Saddle Leather Holster for scoped handguns**, belt type (illustrated above), specify tan or black, \$9.95 each.

**Saddle Leather Holster for scoped XP100**, belt type, tan only, \$17.95. **Deluxe Saddle Leather Holster for scoped handguns**, with detachable shoulder strap, (illustrated left) tan only, \$17.95.



# Bushnell Phantom Scope

for Model 94 Winchester  
— other rifles, too\*



No safety problem,  
no drilling,  
no tapping  
to mount Phantom  
on Model 94!

**MB**

A real boon to old timers and those who have trouble focusing on iron sights, the amazing **Bushnell Phantom Scope** front and center on their faithful 94's will give them faster, "dead on" accuracy than they ever dreamed possible. In fact, any shooter, even though to some it may feel a little strange at first, will soon see how the Phantom beats open sights for faster, more accurate shooting. There's absolutely no **safety problem in mounting** because there's **no need to drill or tap** the barrel. The Phantom mounts easily in the dovetail slot just forward of the receiver, to allow for top ejection of cartridge. A full 6" to 21" eye relief lets the shooter utilize the large unrestricted field of the naked eye around the scope, and through the scope both target and crosshairs are crystal clear . . . the fastest possible combination for brush shooting or close range on running game. That's not all. The same Phantom scope gives the same outstanding performance on handguns, too!

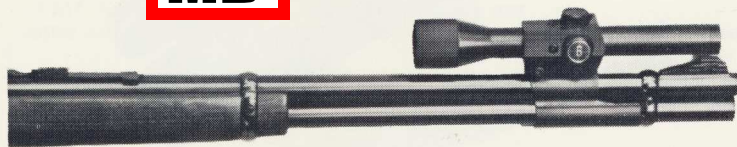

1.3x Phantom **\$24.50**    2.6x Phantom **\$34.50**  
Shipping weight 12 oz.                      Shipping weight 15 oz.

Center Dovetail Mount (above) **\$5.00**  
End of Barrel Clamp Mount (left) **\$5.00**

## Bushnell Phantom tops 'em all with greater accuracy!

### PHANTOM® HANDGUN SCOPES

900 1.3x Phantom Handgun Scope — All Purpose, game, target (medium CH) . . . . .	<b>\$24.50</b>
901 2.6x Phantom Handgun Scope — Varmint and long range, designed primarily for high-velocity pistols, Remington XP100 and .256 Hawkeye (medium CH) . . . . .	<b>34.50</b>
<b>Bushnell Optical Laboratory Conversions:</b>	
1.3x converted to 2.6x . . . . .	<b>12.00</b>
Medium crosshairs converted to fine CH . . . . .	<b>5.00</b>

### PHANTOM® HANDGUN MOUNTS

<b>Clip Mounts (for light calibers)</b>	
910 COLT Officers Model Match .22 & .38 . . . . .	<b>5.00</b>
911 COLT Frontier Scout . . . . .	<b>5.00</b>
912 S&W K or N frame models K.22; .32; .38/44 Heavy Duty; .38/44 Outdoorsman; Combat Masterpiece . . . . .	<b>5.00</b>
913 RUGER Single Six . . . . .	<b>5.00</b>
914 RUGER Blackhawk; Super Blackhawk (suitable only for light loads with these models; rigid top mounts recommended for heavy loads) . . . . .	<b>5.00</b>

### Rigid Top Mounts (for heavy calibers)

920 COLT Python; Three-Fifty-Seven; Trooper; Officers Model Match; <b>New</b> Frontier . . . . .	<b>5.00</b>
921 S&W K.22; K.32; K.38; Combat Masterpiece Combat Magnum . . . . .	<b>5.00</b>
922 S&W .22 Jet . . . . .	<b>5.00</b>
923 S&W .38/44 Outdoorsman; .45 Target 1955; .357 Magnum; Highway Patrolman; .41 Magnum; .44 Magnum . . . . .	<b>5.00</b>
924 REMINGTON XP100 . . . . .	<b>5.00</b>
925 RUGER .256 Hawkeye . . . . .	<b>5.00</b>
926 RUGER Blackhawk; Super Blackhawk; Super Single Six . . . . .	<b>5.00</b>
927 RUGER 10/22 (Phantom and .22 Scopes) . . . . .	<b>5.00</b>

### 94 Winchester Mounts

915 End of Barrel Clamp — no drilling or tapping . . . . .	<b>5.00</b>
*916 Center Dovetail — no drilling or tapping . . . . .	<b>5.00</b>

Also suitable for Winchester models 73, 86, 92, 94, 95, 07, 10, 43, 53, 54, 55, 64, 65, 70, 71, 74 and Single Shots; Marlin Models 93, 94, 95, 27, 336; Remington Models 30, 30S, 141,

721, and 722; Savage Models 99, 20, 40, 45, 340, 342; Stevens Models 322, 325; Mossberg Models.

### Autoloader Side Mounts

928 COLT Gov't Issue .45; Gold Cup; Commander . . . . .	<b>9.95</b>
929 COLT Woodsman Match Target; Sports Model and Target Model; Targetsman; Huntsman . . . . .	<b>9.95</b>

### Holsters (Handgun w/scope)

930-41* Belt type for Colt revolvers; S&W with K frames . . . . .	<b>9.95</b>
930-44* Belt type for S&W frames, up to 6" barrels, Ruger centerfires, up to 6" barrels (does not accommodate Hawkeye) . . . . .	<b>9.95</b>
930-45 Belt type for Remington XP-100 . . . . .	<b>17.95</b>
930-46 Deluxe with Shoulder strap for S&W and Ruger with no more than 6" barrel . . . . .	<b>17.95</b>
930-47 Deluxe with shoulder strap for Ruger .256 Hawkeye . . . . .	<b>17.95</b>
930-48 Deluxe with shoulder strap for Ruger Super Blackhawk, S&W .44 Magnum, 7½" to 8-3/8" barrel . . . . .	<b>17.95</b>

\*Left hand available. Specify tan or black leather.



- finest hard-coated high resolution optics
- outstanding image sharpness • remarkable versatility

# Bushnell Spotting Scope

**Spacemaster 60mm \$95<sup>00</sup>**

prismatic telescope  
(25 x eyepiece included; or your choice of 15 x, 20 x, or 40 x)

The finest all-around telescope you've ever seen! Perfect for any specialized use requiring highest resolution, brightness and contrast. Ideal for applications ranging from nature study to amateur astronomy. (Spacemaster combined with precision camera adapter is also an outstanding telephoto lens!)

Amazing clarity and brilliance is achieved with finest achromatic, color-corrected, coated optics . . . featuring fingertip focusing. Neutral gray, interchangeable eyepieces, retractable sunshade, integral tripod boss, moisture and dust-proof. Protective caps for eyepiece and front lens included.

Weight: 39 oz. Maximum height: 3 5/16"  
Overall length: 15 1/4"

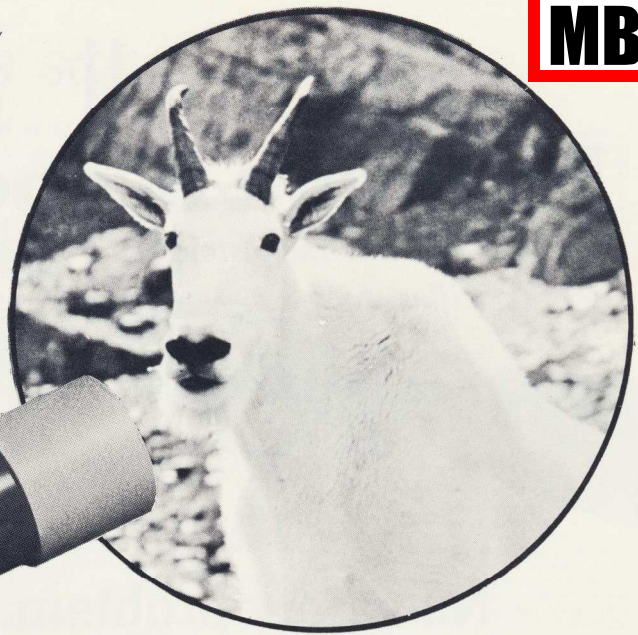

Spacemaster Shipping weight: 4 lbs.

**Bushnell 45°  
60mm prismatic spotting scope \$99.50**

(25x eyepiece included; or your choice of 15x, 20x, or 40x)

Designed specifically to help you achieve top accuracy in target shooting. Scientifically angled eyepiece lets you check shots quickly, without moving from firing position. This means faster, more accurate shooting without strain or fatigue. Hard-coated, achromatic optics. Fingertip focusing system. Protective knob to guard against accidental movement. Neutral gray finish, interchangeable eyepieces, retractable sunshade, moisture and dust-proof.

Weight: 43 oz. Maximum height: 5" Overall length: 16 1/4"



Spacemaster 45° Shipping weight: 4 lbs. 14 oz.

**SPACEMASTER SPECIFICATIONS**

Eyepiece Magnification	Actual Field at 1000 Yds.	Diameter of Exit Pupil
15x	158 ft.	4mm
20x	124 ft.	3mm
20x Wide Angle	175 ft.	3mm
25x	105 ft.	2.4mm
40x	61 ft.	1.5mm
60x	32 ft.	1mm

**SPACEMASTER ACCESSORIES**

- |  |   |       |
|--|---|-------|
| Extra Eyepieces (either model)                             | Bushnell All-Angle Shooter's Tripod (illustrated on 45° Spacemaster and Sentry) | 16.95 |
| 15x, 20x, 25x, 40x, 60x celestial ..... each \$22.50       | Deluxe Case and Strap (illustrated) specify model                               | 10.00 |
| 20x Wide-Angle Eyepiece ..... 27.50                        | Hardwood Tripod with pan head   | 39.95 |
| Achromatized Amplifier (increases power 2 1/2 times) 22.50 |   |       |
| 4-Eyepiece Turret for quick interchange of eyepieces 22.50 |   |       |



**Bushnell  
Sentry  
50mm prismatic  
spotting scope**

**\$54.50**

Terrific value for pistol or rifle shooter. Finest hard-coated, high resolution optics. Extremely compact, has retractable sunshade, tripod socket. Great space saver for field use, weighs only 24 oz., 13" long with protective caps. Neutral brown crystal finish with 20 x eyepiece.



Sentry Shipping weight: 3 lbs.

- Extra Eyepiece 20x, 32x, 48x ..... each, **\$19.50**
- Bushnell All-Angle Shooter's Tripod (illustrated on Sentry and 45° Spacemaster). Lightweight, extremely rigid, micro-screw adjustments, worm-screw ring clamp. Can be folded with scope attached. Durable aluminum with crystal gray finish ..... **16.95**

Protect eyes with lenses  
four times stronger than optical glass

**NEW  
SHOOTING GLASSES \$16<sup>95</sup>**

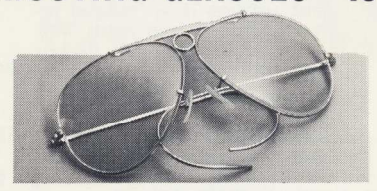

NEW BUSHNELL SHOOTING GLASSES give greater eye safety than ever before from ricocheting shot, wind, dust and powder gases. Lenses of finest optical quality are scientifically curved to protect vision from all angles. A product of space age research in optics, the thermosetting organic lenses are four times stronger than optical glass, weigh about half that of other shooting glasses, and are resistant to solvents, chemical agents and acids, including hydrofluoric acid which corrodes glass. The yellow lenses cut haze for maximum contrast, greatest shooting efficiency, and are distortion free, shatter proof, fog and scratch resistant. Gold filled, wire frames with universal fit, have Nylok screws that will not loosen, plastic covered brow bridge. Price including hard fitted carrying case, **\$16.95.**



# ASTRONOMICAL-TERRESTRIAL Bushnell TELESCOPES

## SKY CHIEF II

Bold adventure awaits you when you look through the Bushnell Sky Chief II telescope. Explore the earth and the universe beyond, travel across mountains and plains, far out to sea, into the starry night. A wide range of eyepieces (20mm, 12.5mm, 6mm, plus 2x Barlow lens) deliver from 45x to 304x magnification, drawing the most distant objects into intimate range, sparkling, life-like, breathtaking to behold! All lenses are hard-coated, fully color-corrected.

### SKY CHIEF II SPECIFICATIONS

**Objective Lens:** 60mm, achromatic, hard-coated, air-spaced. **Eyepieces:** K 20mm (45x magnification), HM 12.5mm (73x magnification), HM 6mm (152 magnification). 2x Barlow Lens doubles power of each eyepiece. **Auxiliary Finder Telescope:** 6x, 30mm cross-wire reticle, fully adjustable. **Equatorial Mount:** Flexible cables for slow motion controls, easily positioned for use as alt-azimuth mount. **Additional Equipment:** Zenith Diagonal Prism for overhead viewing; moon and sun filters for safe solar observation; prism erecting system for terrestrial viewing; hardwood tripod, adjustable, fully-braced, with accessory tray. **Weight:** 38 lbs., including fitted hardwood carrying case.

**Shipping Weight:** 43 lbs.

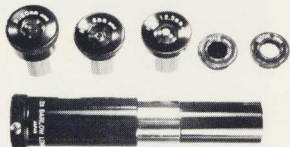

**Accessory Eyepieces:** # 653 18mm (50x), \$12.95; # 656 22mm (41x), \$9.95; # 655 25mm (36x), \$14.95; # 652 40mm (23x), \$12.95.

# 614 Sky Chief, complete with hardwood tripod and fitted hardwood carrying case, only \$159.50.



## ZOOM OBSERVER

Here's an ideal instrument for low-cost, year 'round entertainment, The Bushnell Zoom Observer. Its hard-coated, color-corrected optics produce a bright, clear picture that zooms from 16.5x to 50x magnification to give you a wide range of viewing excitement for astronomical and terrestrial use. It's exceptionally portable, too . . . a hardy traveling companion that can be tucked away in any spare corner of the car.

### ZOOM OBSERVER SPECIFICATIONS

**Objective Lens:** 40mm, hard-coated achromat. **Eyepiece:** Zoom, from 16.5x to 50x magnification. **Alt-Azimuth Mount:** Variable tension, vertical and horizontal movements; with removable 11" metal table tripod. **Dimensions:** 22½" focused at infinity; 2 lbs. 2 oz. Lightweight aluminum body, gray and blue baked enameloid finish.

# 611 Zoom Observer, only \$29.50 complete.

**Shipping Weight:** 41 lbs. 4 oz.



## SKY ROVER

Versatile, yet simple to use, the sleek, streamlined Bushnell Sky Rover is the perfect family telescope. Its amazing Power Command gives the equivalent of eight individual eyepieces. With the flick of a finger you choose medium power, wide field magnification for nature study, satellite tracking, general observation . . . or instantly command reserve power for a close look at planets and stars. Complete portability makes it ideal for every viewing pleasure.

### SKY ROVER SPECIFICATIONS

**Objective Lens:** 50mm air-spaced, hard-coated achromat. **Eyepiece:** 22mm gives 25x to 60x magnification. **Auxiliary Finder:** Peep-sight type. **Alt-Azimuth Mount:** Variable tension, vertical and horizontal movements; with adjustable metal table-top tripod. **Dimensions:** 23½" closed; 30" extended; 3 lbs. 8 oz. Lightweight aluminum body, gray and blue baked enameloid finish.

# 612 Sky Rover, only \$49.50 complete.

**Shipping Weight:** 7 lbs.



### SKY ROVER ACCESSORIES

# 674 Zenith Diagonal Prism for overhead observation, \$8.95. # 672 Safety Solar Filter for sun observation, \$1.75; # 455 Extra Sturdy Hardwood Tripod, \$39.95. # 652 40mm Eyepiece (15x-33x with Power Command), \$12.95. # 654 12.5mm Eyepiece (65x-120x with Power Command), \$9.95.



# Discover New Adventure in Telephotography

## Bushnell TeleVar



350mm-650mm,  
one compact lens



Light, compact,  
variable telephoto  
with zoom versatility for  
single lens reflex cameras

### SPECIFICATIONS

Length: 7 1/4", Weight: 19 oz., Shipping Weight: 2 lbs. 10 oz.

TeleVar variable 350mm-650mm for cameras with removable lenses (some cameras require an additional adapter) ..... **\$59.50**

TeleVar 325mm focal length only, for cameras without removable lenses (series V filter ring is necessary) ..... **\$49.50**

Exciting sports pictures, rare closeups of animals, extraordinary detail shots of buildings and statues, delightful candid shots of children at play . . . Bushnell's TeleVar captures these and thousands of other breathtaking scenes and events that have always been beyond reach of the normal camera lens. Zoom flexibility offers focal lengths that vary from 350mm to 650mm, lets you choose exactly the size picture you want without changing positions. Light in weight and compact in design, TeleVar travels easily, is always ready for use and easy to use.

TeleVar adapts easily and quickly to 35mm, 2 1/4 x 2 1/4 single lens reflex cameras, or cameras using an auxiliary reflex housing with Leica screw mount. Special highest quality optics produce superb brilliance and sharpness from 14" to infinity; Featherlight magnesium frame reduces weight and permits ease of handling; knurled ring around front lens provides rapid, precise focusing. A superb monocular, TeleVar can also be used with a rubber eye shield as a separate viewing instrument for sports events, nature study, travel.

Telephotography is now within your reach! TeleVar proves long range lenses don't have to be heavy, cumbersome and expensive. Try TeleVar and prove it to yourself.



Pentax with 58mm Takumar lens

TeleVar at 650mm

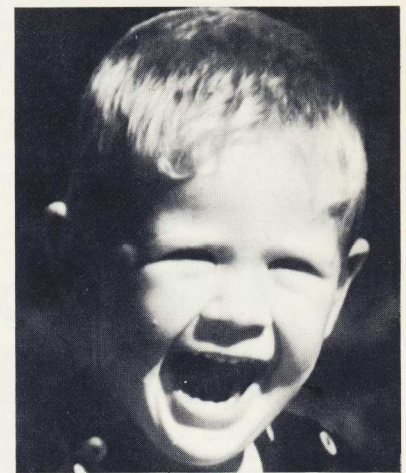

Exakta with 58mm Biotar lens      Spacemaster at 1500mm



## EXTRA LONG RANGE TELEPHOTO MAKES SUBJECTS 60 TIMES LARGER!



## Spacemaster

### 750mm through 3000mm Telephoto

Unapproachable subjects leap into focus 20, 40, 60 times larger with Bushnell's astounding Spacemaster telephoto unit. Put aside bulky, weighty, inflexible, conventional telephotos. Here, at last, is an extra long range lens that offers focal lengths from 750mm to 3000mm, takes superb pictures with virtually all 35mm single lens reflex cameras, and is light and compact enough to carry in one hand. Best of all, Spacemaster is priced for every photographer to enjoy.

Designed for easy use, Spacemaster gives • versatility of focal lengths plus • interchangeable eyepieces: 15x, 20x, and 25x • magnification positions clearly engraved by focal length and f/value for quick, accurate focusing and shutter settings • direct connection to camera body for perfect alignment with absolute rigidity • reduced internal turbulence with prism-shortened air column • less vulnerability to tripod vibration.



Spacemaster  
at 960mm

Used separately, Spacemaster is an outstanding all-purpose telescope, wonderful for vacations, nature study, target spotting, star gazing, and general viewing. Two brilliant instruments for the price of one, Spacemaster's versatility brings a lifetime of year 'round pleasure to your family — a bonus you'd never expect from a telephoto lens!

Weight: 39 oz. Maximum height: 3-5/16" Overall length (without camera): 17" Shipping Weight: 4 lbs.

750-1500mm Spacemaster #412 .....	\$110.00
1500-2160mm Spacemaster #415 .....	110.00
2160-3000mm Spacemaster #418 .....	110.00
750-3000mm Spacemaster Combination .....	155.00

# Telephoto Prices and Accessories (Please specify camera when ordering)

## TELEVAR® 350mm-650mm Variable Telephoto

Code	Model	List
345	TeleVar Unit (with set of four Exposure Control Discs and carrying pouch)	\$44.50
When ordered for single lens reflex cameras with removable lenses, one of the following Variable Mounts is required:		
B	Variable Mount — Exakta Bayonet type	15.00
S	Variable Mount — Pentax/Praktica Screw type	15.00
LV	Variable Mount — Leica Visoflex Screw type	15.00
RBT	Variable Mount — Retina/Bessamatic/Tower type	15.00
Some cameras require special Camera Body Adapters. When ordered for single lens reflex cameras with non-removable lenses, the Fixed Mount is required.		
FM	Fixed Mount	5.00
Most non-removable SLR cameras require a Step-Down to Series V Filter Ring.		

### TeleVar Accessories

354	Combination Filter Holder (for Series VII filters) and Near Focus Lens — Threaded fit the front of the #345 Televar Unit. Near Focus Lens permits focusing on the subjects much closer than would otherwise be possible. There will be variations in distance because of differences in TeleVar-camera combinations.	\$ 7.95
355	Exposure Control Discs, set of 4 — Stops down lens for increased depth of field. (1 set included free with each TeleVar Assembly)	1.00
356	Televar Iris Diaphragm — Eliminates necessity for Exposure Control Discs. Provides faster, more versatile exposure control	14.50
373	TeleVar Tripod Adapter & Support — Provides balanced support for TeleVar and camera on tripod.	5.00
374	Soft Leather Carrying Pouch — 3" diameter x 8", with zipper. (Included free with each complete TeleVar Assembly)	5.00

## SPACEMASTER® 750mm-3000mm Variable Telephoto

400	Spacemaster Unit for single lens reflex cameras with removable lenses (choice of one eyepiece included).	\$95.00
412	15x eyepiece (750mm-1500mm)	22.50
415	20x eyepiece (1500mm-2160mm)	22.50
418	25x eyepiece (2160mm-3000mm)	22.50
With each Spacemaster Unit, one of the following Variable Mounts is required:		
464B	Variable Mount — Exakta Bayonet type	15.00
464S	Variable Mount — Pentax/Praktica Screw type	15.00
464LV	Variable Mount — Leica Visoflex Screw type	15.00
464RBT	Variable Mount — Retina/Bessamatic/Tower type	15.00
Some cameras require special Camera Body Adapters.		

### Spacemaster Accessories

Code	Model	List
413	Shur Focus (Ground Glass) 15x eyepiece for non-reflex cameras	\$22.50
432	Car Window Mount	11.95
443	Deluxe Aluminum Tripod	22.95
445	Extra Sturdy Hardwood Tripod	39.95
451	Turret (accommodates 4 eyepieces)	22.50
453	Deluxe Case (for Straight Spacemaster)	10.00
465	Photo Light Shields, ea.	.50
467	Near Focus Lens #1	9.00
468	Near Focus Lens #2	9.00
470	Near Focus Lens #3	9.00
478	Exposure Control Discs (set of four)	9.95
479	Extension Saddle; minimizes vibration	3.95

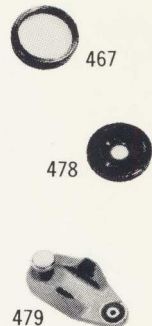

Full color folders and details on How to Order Spacemaster or TeleVar on request.

# Bushnell Microscopes for the Home Laboratory

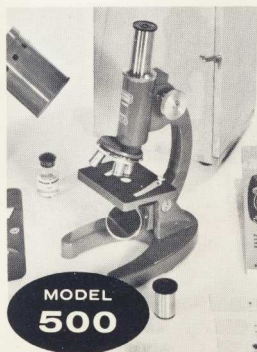

Here's a fine optical instrument which offers a full range of magnification at a new low price... ideal for the beginning student.

#### SPECIFICATIONS:

- Rack-and-pinion focusing with dual control
- 45° inclinable base
- Substage mirror
- Triple objective turret
- Substage aperture control

**DIMENSIONS:** Height, 9"; weight, 1 lb. 12 oz. **ACCESSORIES:** Eyepieces and objectives  
Microscope per specifications, complete with fitted hardwood carrying/storage case, **\$29.50\***

#### POWER CHART (all optics included as shown):

OBJECTIVES	EYEPIECES		Figures inside boxes indicate total magnification
	10x	15x	
8x	80x	120x	Figures inside boxes indicate total magnification
20x	200x	300x	
40x	400x	600x	



The '501' microscope offers unerring Bushnell quality with extra sturdiness and added features... an exceptional value for the secondary school student or the home laboratory.

#### SPECIFICATIONS:

- Rack-and-pinion focusing with adjustable tension dual control
- 45° inclinable base
- Triple objective turret
- Standard diameter eyepieces; objectives with Standard Society threads
- Hard-coated optics
- Stage drilled and tapped to accommodate mechanical stage accessory
- Double substage mirror, plano-concave
- Substage aperture control

#### POWER CHART (all optics included as shown):

OBJECTIVES	EYEPIECES		Figures inside boxes indicate total magnification
	8x	15x	
4x	32x	60x	Figures inside boxes indicate total magnification
10x	80x	150x	
40x	320x	600x	

**DIMENSIONS:** Height, 10½"; weight, 3 lb. 6 oz.

**ACCESSORIES:** Eyepieces and objectives

Microscope per specifications, complete with fitted hardwood carrying/storage case, **\$47.50\***

\* Complete with Basic Dissecting Kit, consisting of tweezers, knife, spatula, scissors, magnifier, pins, and prepared slides, plus an interesting and educational book, "Hunting with the Microscope."

Model 518

## ALL-PURPOSE HAND MICROSCOPE



Versatile microscope for botany, zoology, entomology, chemistry and medicine... in industry for textile analysis, lithography control and TV color alignment.

Over-all size permits desk-drawer or coat-pocket convenience.

**\$14.95**  
with leather case

**SPECIFICATIONS:** Rack-and-pinion focusing · one each, opaque and clear plastic bases · 2¾" working distance · 25x magnification · Height, closed 5½"; extended 8"; weight: 8 oz. · Shipping weight: 1 lb.



## 522 MICROSCOPE ILLUMINATOR \$4.50

With built-in blue filter, adjustable for transmitted or reflected light; complete with 20-watt bulb. (Extra bulbs \$3.50)

College and Medical Microscope or Industrial Microscope Catalogs on request.

Introducing...  
a precision telescopic sight  
for archers...

# Bushnell Bow Scope

- increase accuracy
- refine shooting

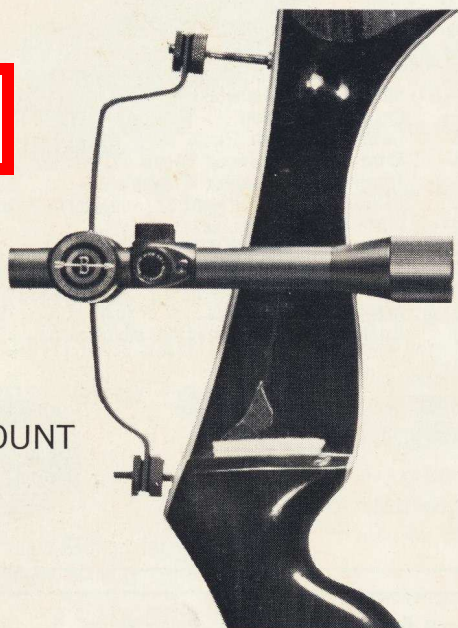

BACK MOUNT

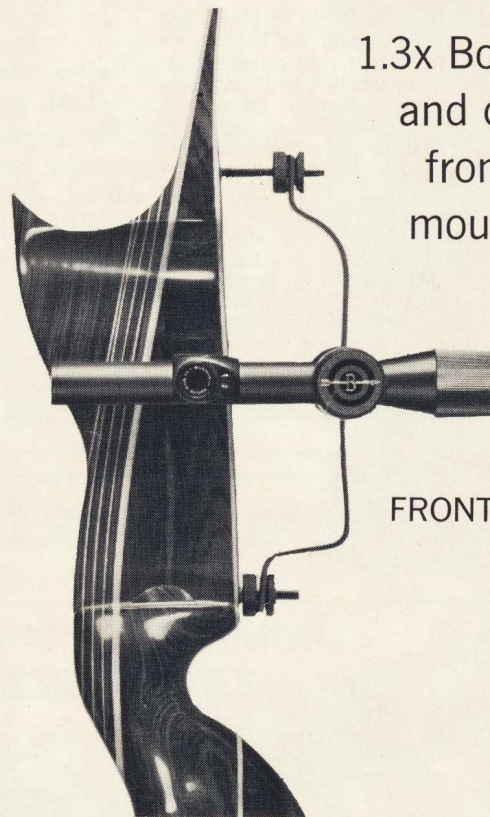

FRONT MOUNT

1.3x Bow Scope  
and choice of  
front or rear  
mount **\$39<sup>50</sup>**



## Bushnell Bow Scope and Accessories

950	1.3x Telescopic Bow Scope (A)	<b>\$22.50</b>
960	Front Mount (for bows best suited for front mounted scope) (B)	<b>\$17.00</b>
961	Back Mount (for bows best suited for rear mounted scope)	<b>\$17.00</b>
971	Bow Scope Carrying Sheath with belt loop. (C)	<b>\$2.95</b>
972	4° Deviation Prism (D)	<b>\$7.95</b>
181	Bushnell 6x25 Custom Compact Binocular, 3" high, gives full field with or without eyeglasses thru unique optical system and extendible eyecups. (E)	<b>\$59.50</b>
S-99	Bushnell Shooting Glasses (F), lenses 4 times stronger than ordinary optical glass. Yellow lenses cut haze for greater contrast, increased shooting efficiency. Gold filled wire frame, universal fit. Lightweight, distortion-free, shatter-proof, scratch and fog resistant. Hard, fitted carrying cases included.	<b>\$16.95</b>

Bow Scope Shipping weight: 10 oz.

Mount (Bow Scope) Shipping weight: 9 oz.

Now, archers can improve accuracy and refine shooting with the exciting new Bushnell 1.3x Bow Scope . . . the first precision telescopic bow sight offered at a reasonable price.

The Bushnell Bow Scope gives archers the advantage of having both target and sight on the same plane of vision, giving a viewing picture that is clear and brilliant, even under poor lighting conditions. Tests by expert target shooters showed increases in accuracy up to 80%.

A long eye relief makes the Bow Scope versatile enough for any archer. A crosshair reticle gives exact aiming point. Reticle adjustments on scope provide fine precision adjustments. Large elevation adjustments are made by moving scope up and down on the mount.

The new scope adapts to any bow (rear or front mounts available). Mount arc accommodates adjustments for distances of seventy yards or more. If archer does not want to "hold over" at extreme ranges he can affix the 4° prism. The telescopic sight can be easily removed from mount bracket when not in use.

Binoculars • Riflescopes • Handgun Scopes • Spotting Scopes • Archery Bow Scope  
Telescopes • Telephoto Lenses • Microscopes • Shooting Glasses • Sunglasses

For the finest in Sight . . . Bushnell

# WOW did we ever goof!

**FREE** Please send me your 20-page catalog,  
"Bushnell '65... All That's New in Sight"

Name: \_\_\_\_\_

Address: \_\_\_\_\_

City: \_\_\_\_\_ State: \_\_\_\_\_ Zip: \_\_\_\_\_

**OO Bushnell '65**

Bushnell Building, Pasadena, California  
In Canada: 1310 West 6th Avenue, Vancouver, B.C.

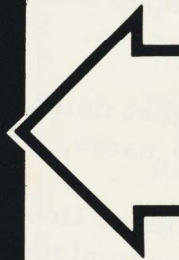

We put this coupon  
in the national ads\*  
introducing our  
new products !

We were confident our  
unique new product designs  
were winners. Test reports  
from experts in the field  
were enthusiastic. Naturally,  
a big response to the  
ads was estimated.

But, WOW, did we ever goof!



Millions of active outdoor families are being presold these exciting new products in the biggest, most far reaching ad campaign in Bushnell history in such leading magazines as:

Sports Illustrated

Field & Stream

Popular Photography

Outdoor Life

Sports Afield

Modern Photography

American Rifleman

Argosy

... and many others !!

# We completely underestimated the response . . .

**MB**

Wires, calls, letters, orders poured into our offices  
from profit minded dealers all over the country:

"Ship Featherlight II Binoculars featured in  
your ad immediately to meet customer demands.  
Need catalogs, too!"

"Swamped with requests for new Bushnell  
Sunglasses. Rush display unit. Include catalogs."

"Biggest demand I've ever seen for binoculars by  
brand name. Rush the following order."

"Greatest line of new products we've ever seen.  
Send complete catalogs for counter use."

Our inquiry department got behind  
with replies, even with extra help!

Our shipping department got behind  
even working overtime!

We ran out of catalogs\* which put  
us behinder than ever!

In brief . . . we goofed!

\* Our new supply is in,  
so we've enclosed a  
counter copy for you.  
Pocket size, giveaway  
catalogs are FREE  
with your Vacation  
Special Orders (see  
back page for offer  
details).

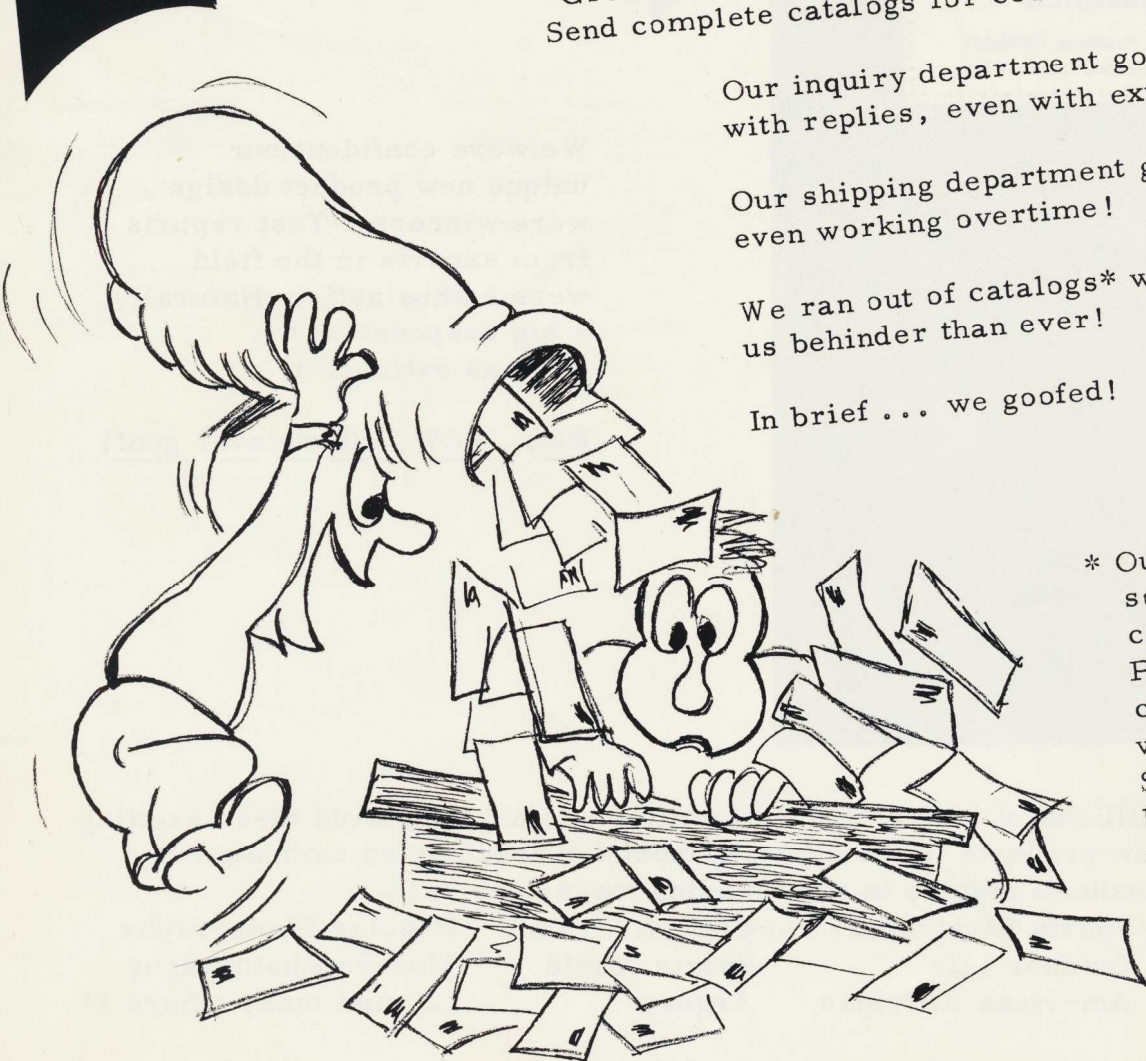

# Bushnell Microscopes for the Home Laboratory

• 20-year warranty

College and  
Medical Microscope,  
or Industrial  
Microscope,  
catalogue on request.



## Bushnell Models offer unparalleled values. Compare!

These are your answers for accurate, high precision microscopes to equip a home laboratory, or to encourage the progress of the junior scientist in your house. Bushnell microscopes are designed and tested for practicability and

excellence by Bushnell optical and mechanical engineers, in collaboration with actual users in the field. Bushnell microscopes have been pre-tested for eye-comfort and durability. Finished in baked grey enamel.

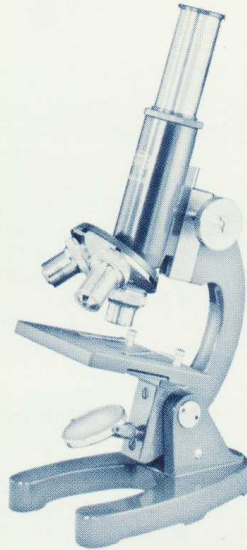

### Bushnell MODEL #90-5010

Top rating by consumer test group, this exceptional microscope is ideal for the secondary student and for the home laboratory. Unerring Bushnell quality with extra sturdiness and added features.

#### SPECIFICATIONS:

Rack-and-pinion focusing with adjustable tension dual control • 45° inclinable base • Triple objective turret Standard diameter eyepieces; objectives with Standard Society threads • Hard-coated optics • Stage drilled and tapped to accommodate mechanical stage accessory • Double substage mirror, plano-concave • Substage aperture control. Height, 10½"; Weight, 3 lb. 6 oz. Complete with dissecting kit, hardwood case and how to use booklet (see description below).  
#90-5010 **\$47.50**

#### POWER CHART

All optics included as shown. Figures inside boxes indicate total magnification.

		EYEPIECES	
		10x	15x
OBJECTIVES	4x	40x	60x
	10x	100x	150x
	40x	400x	600x



### Bushnell MODEL #90-5000

Unparalleled value for the beginning student, an accurate, high precision microscope which offers a full range of magnification at a new low price.

#### SPECIFICATIONS:

Rack-and-pinion focusing with dual control 45° inclinable base • Triple objective turret • Substage mirror • Substage aperture control. Height, 9"; Weight, 1 lb., 12 oz. Complete with dissecting kit, hardwood case, and how-to-use booklet (see description below).  
#90-5000 **\$29.50**

#### POWER CHART

All optics included as shown. Figures inside boxes indicate total magnification.

		EYEPIECES	
		10x	15x
OBJECTIVES	8x	80x	120x
	20x	200x	300x
	40x	400x	600x



#### Microscope Illuminator

Built-in blue filter, adjustable for transmitted or reflected light; complete with 20-watt bulb.

#91-0020 **\$4.50**  
(extra bulbs \$.35)

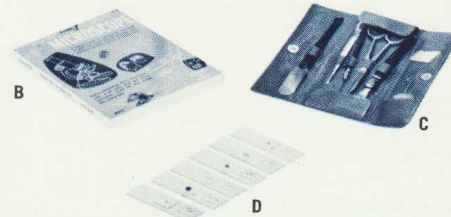
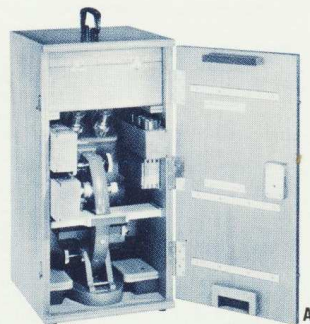

#### INCLUDED WITH EACH BUSHNELL HOME LABORATORY MICROSCOPE

**A. Hardwood Case:** Fitted carrying/storage cabinet of handsome, durable, fine-grain hardwood provides protection for the lifetime of your instrument.

**B. "Hunting with the Microscope",** an interesting and educational book, tells you how to use your microscope.

**C. Basic Dissecting Kit** consists of tweezers, knife, spatula, scissors, magnifier, and pins.

**D. Six prepared slides.**

# SPECIAL TILL JULY 4



## ORDER ALL YOUR BINOCULAR NEEDS FROM BUSHNELL

## USE THE REPLY CARD

### DATING PLAN

#### UP TO 90-DAYS TO PAY

Orders received by July 1, 1965 for any Bushnell products totaling \$150.00 or more, dealer net, have up to 90-days to pay (1% cash discount if paid within 30-days). We pay the postage.

FREE: 50-"Bushnell '65" pocket catalogs shipped Free with every Vacation Dating Plan order on enclosed card.

#### FEATHERLIGHT I BINOCULAR CLEARANCE

Once-in-decade opportunity! Discontinued Featherlight I 7x35 CF Binoculars. World famous and consumer rated equal of binoculars costing many times its \$74.50 price!

LIST PRICE \$74.50

CLEARANCE PRICE  
ONLY \$33.88  
(Dealer Net)  
(formerly \$44.70)



SPECIFY #144 Featherlight  
7x35CF "Clearance"

(Limited stock - delivery made on first come, first served basis.)

#### SPORTVIEW BINOCULAR SPECIAL OFFER

For immediate delivery  
No quantity requirement!

<u>Code</u>	<u>Model</u>	<u>Special</u>
190	6x30 CF	\$14.75 net
191	7x35 CF	\$15.75 net
193	7x50 CF	\$21.25 net
194	8x30 CF	\$15.75 net

#### \*EXTRA SPECIAL\*

192 Wide Angle 7x35 CF  
only \$23.98 net  
(Illustrated below)

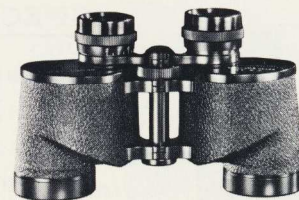

(No retroactive credits will apply on purchases made prior to this offer.)

### BINOCULAR SPECIALS

# For your biggest year ever... Bushnell '65