

UNITED'S *New* POWER SPOTTING SCOPE

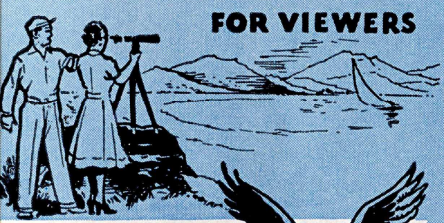

20 POWER - 40 MM
Prismatic SPOTTING SCOPE
 Weighs Only 6 Ozs.—8¾ Inches Long
Another UNITED First



FOR VIEWERS

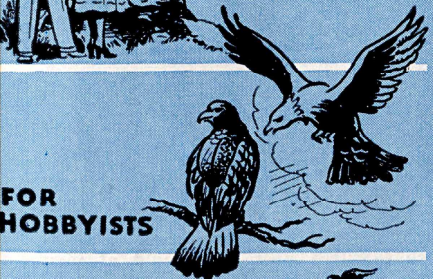

FOR HOBBYISTS

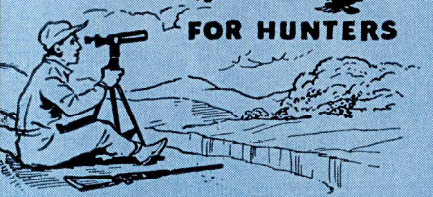

FOR HUNTERS

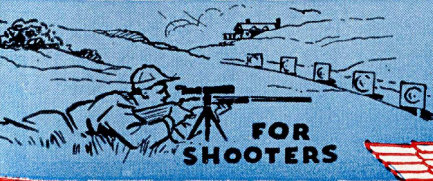

FOR SHOOTERS

A compactly made, precision machined Prismatic Spotting Scope. Quality construction throughout. Threaded metal fittings. The Scope itself weighs only 6 ounces! Is only 8¾ inches in length. The price of \$24.95 complete with tripod, makes it an outstanding buy for those who want top results at a reasonable cost.

Has a luxurious black crackle finish, handsomely trimmed with chrome. Comes with safety dust cap which screws into position over large front lens when not in use.

107½ FOOT FIELD AT 1000 YARDS
 Not a mere telescope, but instead, just like an expensive Binocular, PRISMS ARE USED to eliminate distortion, give a greater field of view and assure the user sharp, detailed definition at all distances. The Vital inside surfaces of front and rear Achromatics have been COATED for brighter, clearer images.

The Uni-Tripod is manufactured of sturdy, durable, "whisper weight" Duralumin giving you a minimum of bulk and weight. Tripod is engineered with swivel head so you can sight up, down, across or at any angle you choose. Made in Japan to rigid UNITED REQUIREMENTS by skilled optical craftsmen which explains why the quality is so high and the price so reasonable.

Both Scope and Tripod \$24.95 Only.....

(Federal Tax Free)

Handsome Leather Carrying Case and Straps, Accommodates Scope and Tripod \$3.95



UNITED BINOCULAR CO. UNITED BUILDING 9043 SO. WESTERN AVE. CHICAGO 20, ILLINOIS

BINOCULARS

with the



MB

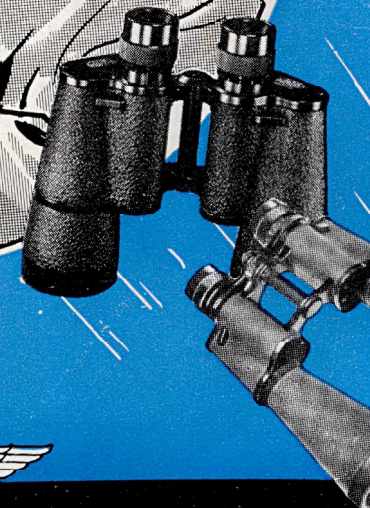

UNITED BINOCULAR CO. UNITED BUILDING 9043 SO. WESTERN AVE. CHICAGO 20, ILLINOIS

United Binocular Company

UNITED BLDG., 9043 S. WESTERN AVE. phone: HILLTOP 5-6166
CHICAGO 20, ILLINOIS

Dear Friend:

Thank you for your inquiry. It will be a privilege to help you choose the binocular or telescope you want.

I have a deep personal sense of obligation to UNITED customers. For thru the years (established 1936) thousands of our customers have returned (in person or by mail) to buy another pair of binoculars for themselves or to give as a gift to friends, relatives or customers. Still thousands of other orders have come to us through the recommendations of satisfied customers.

It is what makes me know that UNITED'S policy of fair dealing . . . of giving the most binocular value possible . . . on an absolute No Risk trial basis is ABSOLUTELY RIGHT.

Many of our customers are buying a binocular for the first time . . . they have an idea of what they want, but are not absolutely certain as to what size or type binocular is best suited for them. Therefore, the only way I can assure their complete satisfaction is to allow them to buy on the UNITED'S UNCONDITIONAL GUARANTEE OFFER (see below). Read it carefully--see how it protects you. It is my way of guaranteeing your absolute satisfaction . . . in my opinion, it is one of the big reasons why UNITED is known as "America's Leading Binocular Retailer."

Fill out the enclosed Rush Order Blank and mail it today in the enclosed self addressed, postage paid Airmail Envelope . . . our 30 Day Money Back Guarantee protects you . . . and if you are in a rush, we will Air Mail (Page 24) your selections to you.

Cordially yours,
UNITED BINOCULAR CO.

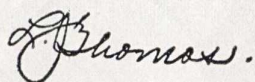

L. J. Thomas, Executive Director



Unconditional Guarantee!

BUY-TRY any binocular shown in this catalog for 30 days (one full month) AT OUR RISK AND EXPENSE. If not completely satisfied in every way, return for an immediate, unquestioned refund of every penny you paid us!

When Choosing a BINOCULAR

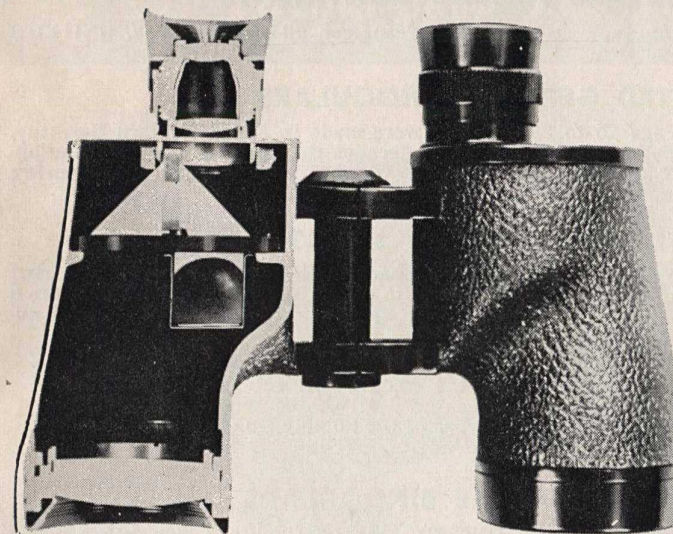

Cross section of our Precision Binoculars showing how prisms are set on metal shelf and firmly held into position with metal bands.

is that objects viewed will appear seven times larger than when just viewed by the naked eye. Therefore, the larger the first number the greater the magnification. The SECOND number, the "35", is the measurement in millimeters of the diameter (width) of the front (large) objective lens. Example: Since "25" mm are equal to approximately one inch the figure "35" would indicate the front objective lens would measure approximately 1½ inches across. The larger the number, at a given power, the more light gathering capacity and the greater the brilliance and sharpness of detail of the object you are viewing. All UNITED specifications of power and light transmission are twice triple checked for absolute accuracy.

FIELD OF VIEW

Is what you see through your Binocular from right to left or left to right at a given distance. All UNITED "field of view" specifications are given at the recognized standard of 1000 yards. Therefore, our listing of "field of 375 feet" means that at 1000 yards the width of your vision is what you would be able to see at 375 feet.

COATING BINOCULARS

Because there have been so many exaggerated claims of superiority for "coating" binoculars that have been deliberately misquoted to confuse the buyer and are not fair to the buying public, UNITED wishes to point out these important facts:

1. What Coating is
 2. The Value of Coating
 3. The EXTRA EXPENSE to the buyer for Coating.
1. COATING is an application of a transparent surfacing of magnesium fluoride.
 2. COATING simply reduces internal light reflections which cause annoying "flares" and "ghost images."
 3. COATING today costs only a few dollars extra per binocular. Mass production methods have made this low price possible. Coating assures you satisfaction and increased binocular enjoyment and binocular efficiency. Mr. Jim Mitchell, Editor of HUNTING & FISHING recently wrote to us: A neighbor, an airplane pilot, just recently purchased binoculars—without coating—and when he compared them with your UNITED Binoculars he was certainly an unhappy individual."



BUY UNITED AND SAVE

BE SURE THAT

The Binocular you buy is sold by a reputable firm—a firm that stands back and squarely in favor of the binocular you purchase. A firm with a reputation of binocular "Know How," Dependability and Fair Dealing. UNITED has served over 600,000 folks and established the UNITED 30 DAY MONEY BACK GUARANTEE offer in 1936!

WHAT 7 x 35 MEANS

The FIRST number, the "7", designates the power of your Binocular. It means your binocular will bring objects you are viewing 7 times closer to you. Or, another way of saying it,

BINOCULARS FROM 3 CONTINENTS

To satisfy American wants, and at prices Americans can all afford to pay, UNITED'S "Best-By-Test" binoculars come from 3 continents!

UNITED GERMAN BINOCULARS

Those binoculars listed on Page 25 to 29 inclusive were made in Allied Western Germany, the Mother Inventor of Prismatic Binoculars and for decades the home of many revolutionary optical achievements. Today's UNITED "Whisper Weight" marvels, among the world's lightest, come from Germany.

GERMAN COATED OPTICS

The German Optical Industry (inventors of Prismatic binoculars) do not as a practice coat the outside of their front and rear Achromatics. Here is the reason and we quote from Page 40 of the December, 1950 issue of the American Rifleman magazine, a recognized authority on Firearms, Scopes and Binoculars.

"The German manufacturers say that processing the exposed surfaces (outside) of the Ocular and Objective lenses is inadvisable as the coating will rub off. This causes a "spotty" appearance of these outer lens surfaces until all the coating has worn off. It does not, however, effect optical clarity. Because of the notably fine reputation of these German makes, their standards were accepted . . .".

UNITED JAPANESE BINOCULARS

These UNITED Binoculars carry the famous UNITED Seal of Quality which assures you they are made of quality materials, skillfully processed and economically priced. During War II skilled craftsmen from Germany, the Mother Inventor of Prismatic Binoculars taught local workmen advanced Binocular techniques. Following the war and under the MacArthur regime, a New Japan was born which has steadily thru the past years moved forward and has become known among nations of the world as one of leading producers of fine Binoculars. It explains why the optical craftsmanship is so HIGH and the prices so LOW for these superb binoculars.

CENTER FOCUS VERSUS INDIVIDUAL FOCUS

CENTER FOCUS means there is a focusing wheel in the middle of your Binocular eye bridge which allows you to manipulate the eye adjustment for distance with the tip of one finger. INDIVIDUAL FOCUS means you focus for distance by first adjusting one eyepiece and then the other. The discussion as to which system is more efficient will rage on for generations. Both have their fine points, with our opinion being that it is a matter of PERSONAL PREFERENCE as to which will give YOU the best results.

30 DAY MONEY BACK GUARANTEE

UNITED'S Brand New binoculars are "bargain priced." Compare their quality of workmanship, materials and performance with other firms' binoculars — and prove UNITED'S Money saving prices for yourself. For 20 years UNITED has sold binoculars on an unconditional money back guarantee. Buy-Try for 30 days (one full month) and if not completely satisfied, return for an immediate unquestioned refund. UNITED wants above all things, your good will and confidence. It has been Quality Merchandise Priced Right plus Fair Treatment that has made UNITED "America's Outstanding Binocular Retailer."

WHICH BINOCULAR SHOULD YOU BUY

6x, 7x AND 10x POCKET BINOCULARS give you a full power glass compactly designed and easy to carry with you everywhere. Powerful little glasses you can slide into your pocket for use at all times.

6x30 AND 8x30 BINOCULARS are considered by many as the 'all around' Binocular for universal use. These are considered 'standard' size glasses.

7x35, 7x40, AND 8x40 give you the combination of MORE power and LARGER front lens. Desirable features long wanted.

7x50, 10x50, 12x50, 15x56, 15x65, 16x50 and 20x56 are conquerors of distance. Here you have HIGH power with LARGE sharp front lens, that as a team, reach out and bring the image right up to you. Now available at UNITED at weights Easy to hold and Easy to focus.

ARE NOT BUYING JUST ANOTHER BINOCULAR

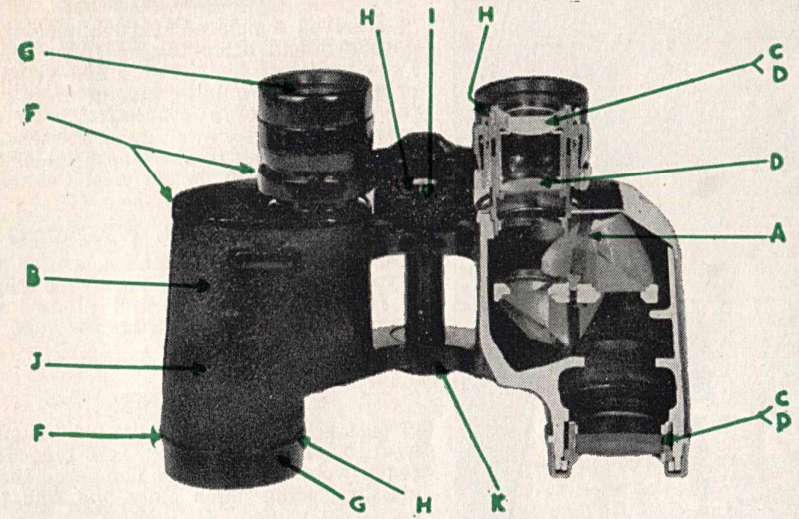

See for yourself the quality construction of all UNITED Binoculars.

- A** Prisms are set on metal shelves and firmly clamped into position with tension spring metal bands—not just cemented into position. Users get more durability, avoid a common breakage problem one experiences when using cheaply made binoculars.
- B** Revolutionary "Whisper Weight" metals and alloys are used to give you sturdy compact bodies that with reasonable care should give you a lifetime of satisfactory service. Notice carefully the streamlined design to give you that wanted "Whisper Weight."
- C** Achromatic lenses are used in UNITED binoculars. In layman's language this means that lenses are cemented together with "Canadian Balsam" to give you color free vision. It eliminates distortion at the edge of your view and gives clear, crisp depth of image.
- D** ALL lenses in UNITED Binoculars are precision ground by skilled optical craftsmen at all edges, surfaces and depth of lenses painstakingly ground to rigid UNITED requirements. Assuring you of SEEING MORE—BETTER.
- E** UNITED cases are made of scuff resistant leather and double sewn throughout the corners and riveted at key points to assure long life. Lined with velvet soft plush cloth for a luxurious appearance and added protection for your UNITED Binocular.
- F** UNITED standard models are made both water and dust resistant with UNITED XTREME SEAL to aid in keeping out undesirable water and dust.
- G** UNITED now happily offers a rich look gloss finish that will not finger smudge or do single enamel shiny applications. The extra enamel applications give you lasting beauty!
- H** All barrels and moving parts are DEEP LONG threaded for additional strength designed to give you better construction and better performance at all times.
- I** All moving parts, focusing mechanisms, etc. are triple tested for smooth trouble free action. Moving parts not TOO loose or TOO tight, JUST RIGHT for easy finger tip adjustment.
- J** UNITED Binoculars come in all popular "Command" as well as "Streamlined" designs for your personal preference. Both are popular and palm fitting (fits your hand like a glove) making UNITED Binoculars a truly great pleasure to use.
- K** All hinged parts are strong and durable—firm to your touch, still smooth and elastic to meet your needs, quickly.



These and many other features are incorporated into UNITED Binoculars to give you a lifetime of pleasure and service even with rigorous use.

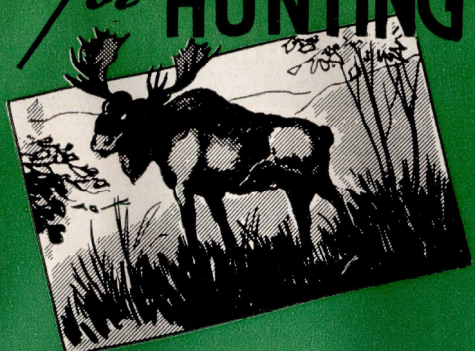

HUNTING
for EVERY PURPOSE

Increase your Hunting Enjoyment and Hunting Efficiency by owning a pair of better than ever UNITED Binoculars. Each year we carefully weigh the expressed wants of Hunting enthusiasts. Our findings are relayed to our factory suppliers the world over—and then mass produced to be offered at UNITED's standard Economy Price Policies.



for
OUTDOOR ACTION..

Is MORE fun when you see MORE. In addition to securing greater fun watching rodeos, sailing regattas, conventions and the like there is that keen deeply felt enjoyment of studying distant animals in their natural habitat scampering over the hills and mountain sides, in the woods or along the flat plains. For most fun use UNITED Binoculars.



for **SPORTS**

Be right in the heart of the most thrilling action by close-up views of boxing bouts, football games, horse races, etc. See minute details, facial expressions, body contacts, etc., at finger tip range. Use scientifically ground, precision constructed UNITED Binoculars.

NAKNEK, ALASKA

"I received a pair of 16x50 binoculars a few days ago and after testing them thoroughly I am well satisfied. For a big game hunter or guide they would be invaluable in checking the condition of a bear's fur or a rack of moose horns miles away. I can see where these glasses are going to save me a lot of walking in the future." J. M., M & M Cannery.

GREEN RIVER, WYOMING

"During the last elk hunting season here in Wyoming, I used one of your 7x50 Binoculars (a friend's) and I was well pleased with it. I am enclosing my check for the 7x50 Binoculars . . ." C. E. T.

VIRGINIA

"I just returned from a "Chuck" hunt and I wish to tell you that your 7x35 binoculars are really wonderful. I have compared them with glasses costing much more and find them to be a real value." C. R. P.

FAIRBANKS, ALASKA

"Enclosed find my check, send me a pair of 16x50 binoculars. I purchased a pair of 6x30 glasses from you two years ago and have been more than satisfied with them. We have used them during the winter and the hunting seasons and have bagged our moose both years. If the 16x50 are as good as the 6x30, I will be more than satisfied." A. K. H.

KOREAN VETERAN

"The 15x-40x Wollensak telescope is great here in Korea. I am sending for a pair of 10x50 binoculars, etc." Corporal J. O. M.

YELLOWSTONE NATIONAL PARK

"Many thanks for rushing the 7x35 German. Am in Yellowstone Park enjoying the glasses." C. K. E.

LANCASTER, PENNSYLVANIA

"... I learned to focus the Telescope (Wollensak) correctly and the results are amazing. I do not wish to part with it . . . on the 40 Power range, objects a mile away seem to be across the street." S. M. S.

**JIM MITCHELL, EDITOR,
HUNTING & FISHING**

"Surprisingly enough, when we were camping at some 11,000 feet and walking to various lakes, I found the binoculars helpful in spotting the best trail in getting to the lakes. This was a new use, for me at least."

STILL MORE PROOF

PROFESSOR JOHN F. LEWIS SAYS:

"The 7x50 Glass came through in fine shape. Thank you very much. It is a VERY GOOD VALUE at the PRICE OFFERED. I have shown the 8x30 Glasses to a number of people and no doubt you will be receiving orders from some of them. They are tremendous values—as are the 7x50 Coated glasses you offer also. I saw one of the 7x50 Glasses in the hands of a bird student nearly 5000 ft. above sea level on a camping trip I made this week end. He was enthusiastic about the glass, as was I after I had the opportunity to use them."

Prof. John F. Lewis,
Professor Biology
C. _____ Penna.



OHIO

"My 7x50 was inspected by a friend of mine, a former Army Captain, who stated that this binocular was equal to, if not more distinct and lighter than the one he used for 3 years in the service. We will be sending you more business . . ." C. E. H.

UTAH

"We received the two pair of glasses ordered from you recently and are well satisfied with them. Enclosing check \$154.80 for which please send me a pair of 8x30 wide angle (field of 450 feet) glasses and a pair of 7x35 German binoculars." W. P. B.

WASHINGTON

"The 16x50 are very good. I would not sell them for a lot more than I paid for them. I'd be afraid I could not get another pair as perfect in fine material and power. I can read the small names on ships (5 inches high) at 800 to 1000 yards." D. W. B.

PENNSYLVANIA

"With my 7x50 CENTER FOCUS UNITED binoculars I can see the Reading Municipal Airport, now called General Spaatz Field, even reading the name Reading Municipal Airport on the side of one of the hangars. From where I stood to the airport in a direct line. I would say it was at least 3 miles. The Blue Mountains at Hamsburg, 18 miles away, were very visible with the 7x50 . . ." C. H. P.

KOREAN MARINE'S MOTHER

"We recently purchased a pair of 6 power-4 ounce binoculars for our son who is a marine in Korea and my husband was so intrigued and pleased with them I want to get him a pair as a Christmas present." Mrs. D. L., Maryland.

LONG BEACH, CALIFORNIA

"I am very much pleased with the 7x40 Binoculars I got from you recently when I was in Alabama. Please send me _____" C. C. C.

CALIFORNIA

"Last fall I purchased a 7x50. I am well satisfied with it. Send a 7x50 to _____" H. W. H.

CORKEVILLE, WYOMING

"Enclosed find check. Send Wollensak 15x-40x Variable Telescope. I recently purchased a pair of 16x50 from you and I am certainly well pleased with them. I think they are superior to many very expensive binoculars I have examined and used." T. A.

ARIZONA

"The 20x56 German are the nicest binoculars I have ever owned. Neatest looking case . . ." T. E. J.

WISCONSIN

"I received the 6x30 Featherweight binoculars. They are a fine pair and will serve my needs adequately." M. M. D.

NEW YORK

"The 10x50 I bought 2 years ago are a fine pair of binoculars." R. A. W.

WEST VIRGINIA

"Please send me a pair of your 7 Power Binoculars. They were highly recommended by our Plant Safety Director." N. V.

PENNSYLVANIA

"Even with the haze in the mountains, my 8x40 glasses were very clear. I showed them to several of my friends and you will probably be receiving orders from them." K. H. R.



QUALITY SELECTION FROM THREE CONTINENTS

DELUXE BINOCULARS

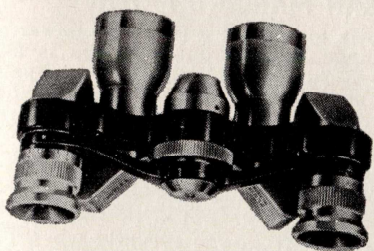

10x20 — \$29.95

USE FOR hunting, vacationing, long distance viewing where pocket size utility is wanted. . . Aluminum Alloy.

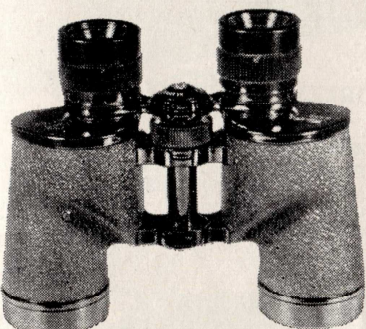

6x30 — \$49.50

USE FOR sports, hunting, motoring, bird watching and general all around use. . .



7x35 — \$59.50

USE FOR all purpose viewing. Bird watching, vacationing, races, motoring, hunting. . .

SUPERB QUALITY OPTICS "WHISPER WEIGHT" FRAMES

Another UNITED "First" . . . True Deluxe Quality binoculars with "Whisper Weight" bodies offering you greater strength and durability and still are FEATHER LIGHT for easy holding and focusing.

Streamlined for surer grip and handsome eye appealing appearance.

Center Focus for fast finger tip adjustment and of course all have individual focusing right eye pieces.

Prisms precision locked into place on sturdy metal shelf with durable metal "spring" bands (as are ALL United Binoculars) for trouble free, lasting collimation and alignment of optics.

Bear UNITED Seal of Quality because are made to rigid UNITED REQUIREMENTS by skilled optical craftsmen in Japan.

Uni-Coated. Internal surfaces of vital prisms and interior sides of front and rear Achromatics are Coated with magnesium Fluoride to eliminate disturbing reflections, and thereby increase light transmission, giving you brighter, clearer images.

Achromatic Lens for crisper, sharper images. No color fringe, or "rainbow" hue at edge of viewing area.

Durable, handsome cases have been created to give your UNITED DELUXE Binocular ample protection. Riveted at all key points. Sewn for extra protection at pressure areas. Plush lined. "Sure-Lock" leather fastener for safety in carrying.

SPECIFICATIONS

Model	Field of View 1000 yds. (in feet)	Relative Brightness	Weight Ounces	Size Inches
10x20	310	4	7	3x3 $\frac{1}{8}$
6x30	437	25	16 $\frac{1}{2}$	4 $\frac{1}{2}$ x6 $\frac{1}{2}$
7x35	376	25	19	5x6 $\frac{1}{2}$
8x40	375	25	24	5 $\frac{1}{2}$ x6 $\frac{1}{2}$
7x50	376	50.4	32	6 $\frac{1}{2}$ x7 $\frac{1}{2}$

ALSO

8x40 an excellent binocular where extra 8 power is wanted, and more brightness desired as is given here with 40 mm. front lens **\$69.50**

7x50 Commonly called "Day and Night" Binocular because 50 mm front lens gives tremendous light gathering power under all lighting conditions. Favorite size of the U. S. Navy. Great All purpose glass. 7x50 size is one of our best sellers. Favorite for Marine Use. **\$79.50**



6 POWER BINOCULAR..

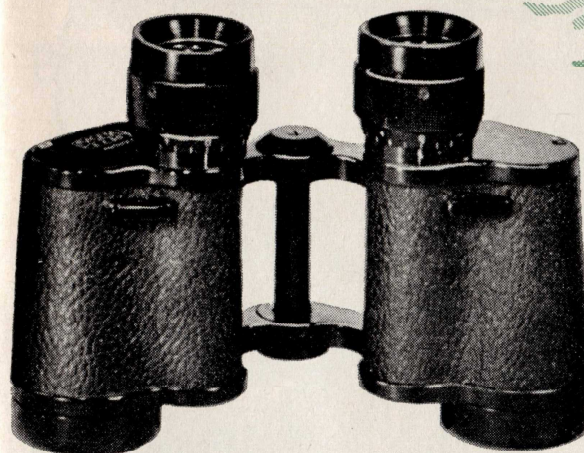

FEATHERWEIGHT INDIVIDUAL FOCUS

6 Power

often referred to by optical experts as the "Universal Power" because of their "UNIVERSAL" appeal. These superb binoculars have etched into the frames the famous UNITED "Seal of Quality" . . . for they have met every requirement. Water, dust resistant. The brilliant featherweight models shown on this page all have a 7.5 degree field and measure a compact 4 $\frac{1}{2}$ "x6". UNITED VALUE. Internal surfaces of vital prisms and front and rear Achromatics are Coated with Magnesium Fluoride to assure you brighter, sharper, clearer images. Made in Japan, these Precision constructed UNITED Binoculars are produced of quality material by skilled craftsmen and are Unconditionally Guaranteed and Economically Priced. UNITED Economy prices include plush lined genuine leather case and straps. Sharp, clear, crisp images.

6x30 have a field of view at 1000 yards of 390 feet and weigh only 15 $\frac{1}{2}$ ounces. **\$34.50**

A. K. H., Alaska, wrote: "Have used the 6x30 glasses the last two years during the winter and have bagged our moose both years. More than satisfied, etc."

6x20

WEIGHS 7 OZS! — — 3x4 $\frac{3}{4}$ INCHES It's New! A full 6 Power Binocular created with a standard frame, still it measures only 3 x 4 $\frac{3}{4}$ inches and weighs only 7 ounces! This is made possible by use of new lightweight metals which are feather lite and assure stronger construction.

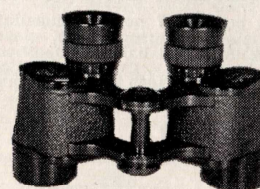

FITS PALM OF YOUR HAND . . . and gives you a WIDER field of view of 393 feet at 1000 yards. Inside surfaces of vital prisms and front and rear Achromatic lens are COATED for crisper, sharper viewing. Individual focus. Comes with fine leather case, which has a loop so the binocular can be worn on the belt. Case also equipped with handy leather handle. Price **\$27.95** plus lower 10% Federal Excise Tax.



7-POWER GLASSES

Easy to Handle
Clear, Crisp--Lightweight

7 x 35

CENTER FOCUS

FEATHER WEIGHT

Thru the naked eye and thru UNITED Binoculars



A popular priced binocular in which UNITED presents instant finger tip adjustments . . . PLUS 7 power optical system . . . PLUS precision machined construction . . . PLUS scientifically ground, polished, achromatic lens . . . PLUS crystal clear viewing . . . PLUS UNITED VALUE! . . . Internal surfaces of vital prisms and front and rear Achromatics are Coated with Magnesium Fluoride to assure you brighter, sharper, clearer images.

FEATURES

Carry UNITED "Seal of Quality." Water-Dust-Resistant. Magnification — 7 Power. Aperture of front lens-35mm. Angular field of view—7.0. Field of View 375 ft. at 1000 yards. Size - 2"x5"x6½". Weight - 20 ounces. Center Focus with Individual Focusing Right Eye. Exit Pupil - 5mm. Made in Japan. These Precision constructed UNITED Binoculars are produced of quality materials by skilled craftsmen and are Unconditionally Guaranteed and Economy Priced. With handsome Leather Case and Straps.

\$49.50

Plus Usual Federal Tax

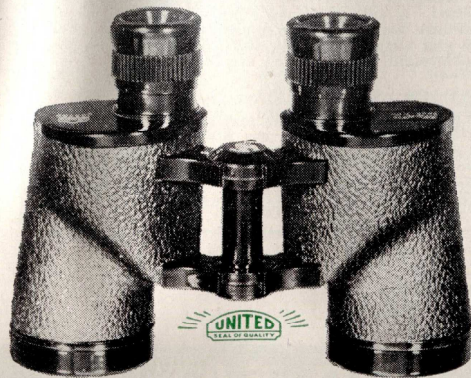

MB

PENNSYLVANIA WRITES:

"Equal to the best and much better than most . . ."

"I am very well pleased with the 7x35 Binoculars, and have shown them to most of the fellows belonging to our Sportsman's Club, the most of whom have binoculars, some of which cost less and the most of them more. They were very much enthused about yours (UNITED) as they were equal to the best and much better than most of them. You will be getting orders from some of them in near future." E. F. S.

7x35

INDIVIDUAL FOCUS

A finely made all purpose 7 power binocular. Designed for sportsmen wanting sharp, clear, long range viewing in a well balanced feather-weight (20 ounce) model. Color corrected lenses. Field of 375 feet at 1000 yards. Leather Case, Straps.

\$45.50

7x35

Economy

Individual focus. Good quality and performance. Bright and crisp. 5½ inches high. Weighs 20 ozs.. Bargain Buy. Fine Leather Case, Straps.

\$27.95

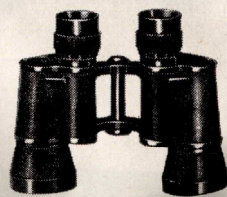

BUY WITH CONFIDENCE-IF NOT FULLY SATISFIED, RETURN FOR PROMPT REFUND

7x50 BINOCULAR

"Day and Nite Glass"

The Style So Popular With Armed Forces the World Over!!

Tremendous Light Gathering Power



Field at 1000 yards is 375 feet!
6¾"x7¼"
Weighs 31½ ounces

The Armed Forces favorite sized Binocular. As military units advance you can be certain that their 7x50 binoculars go with them. For they bring distant objects to seemingly arm length closeness. Both models offered have unusually large 50 MM. objective lens (2 inches across!) and will give sharp, clear images and tremendous light transmission. Ideal for either day or night use. In addition, they provide both an undistorted field of view and have an angular field of 7.1 degrees. Exit pupil 7 MM.

Surfaces of vital prisms and inside of front and rear achromatics are COATED with Magnesium Fluoride to assure you brighter, sharper, clearer images.

Made in Japan. These Precision constructed UNITED Binoculars are produced of quality materials by skilled craftsmen and are Unconditionally Guaranteed and Economy Priced.

Skilled optical craftsmen have combined precision ground and polished optics with superb, durable, all-metal, light weight frames. An optical PLUS . . . particularly when you consider they weigh only 31½ ounces and are bargain priced.

WITH INDIVIDUAL FOCUSING
7x50 UNITED'S "DAY AND NITE" GLASS..... **\$49.50**

P.E.A., Skagway, Alaska, discovered—"A few friends of mine in town have some of your 7x50 Binoculars and I must say I am very much impressed with their construction, performance and looks."

WITH CENTER FOCUSING
7x50 UNITED'S OUTDOOR KING... **\$54.50**

(And individual focusing right eye—38 ozs.)

SALES MULTIPLY: "Well pleased with 7x50. They are good and clear. Enclosed find a check for a pair just like them for my sister-in-law." E.W.W., Texas.

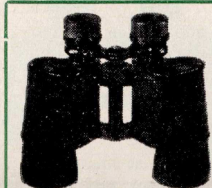

Prices include usual fine plush lined leather case and straps. Add usual federal tax.

8x30 INDIVIDUAL and CENTER FOCUSING

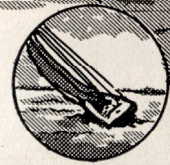
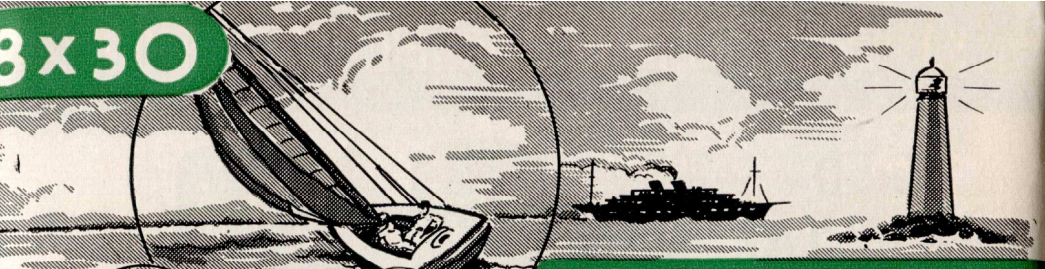

See
MORE

INCREASED POWER

True zephyr weights, weighing only 16 to 18 ounces each! Water-Dust Resistant. Accurate, long range viewing binoculars. This true 8-power champion gives you a 7.5 degree field of vision with a field of view of 390 feet at 1000 yards. Exit pupil 3.6 mm. **UNITED VALUE!** Internal surfaces of vital prisms and front and rear Achromatics are Coated with Magnesium Fluoride to assure you brighter, sharper, clearer images. Each glass on this page has the same compact (4½"x5¼") frame! Real, concentrated power!



MB



8x30 LIGHTWEIGHT CHAMPION

UNITED is proud to offer these super fine individual focusing binoculars especially suited for distance viewing of far off objects. For with these binoculars you secure exceptionally brilliant illumination and razor sharp detail of objects, even miles away. Made in Japan, these precision constructed UNITED binoculars are produced of quality materials by skilled craftsmen and are Unconditionally Guaranteed and Economy Priced. In addition, they have many, many construction features found generally only in higher priced binoculars. With neck and case straps and plush lined carrying **\$39.50** case.

8x30 CENTER FOCUS
With Individual Focusing Right Eye. A Big Value - - - \$45.00

Add Usual Federal Tax

10x30 INDIVIDUAL FOCUS
6.5 Degree or 340 Foot Field. Economy Buy - - - \$45.00

ORDERS THREE MORE PAIR BINOCULARS:
"After inspecting the pair of 8x30 Binoculars I am well pleased and pleasantly surprised at the fine resolution of these Glasses. As I said in my first letter, several of my associates also wanted Binoculars. . . we are enclosing check for \$125.10 for three more pair." M.J.M., Oregon.



8x30 Center Focus



10x30 Model



SUPERB OPTICS — SHARP and CLEAR

8x40

We present here in our opinion a new high accuracy in binoculars. It is easy for us to give UNITED'S unconditional guarantee of satisfaction on these handsome, sturdy, streamlined 8x40 binoculars. We know from hundreds of letters and conversations with satisfied users that you, too, will be thrilled once you handle and use these superb binoculars. **UNITED VALUE!** Internal surfaces of vital prisms and front and rear Achromatics are Coated with Magnesium Fluoride to assure you brighter, sharper, clearer images. Made in Japan, these precision constructed UNITED Binoculars are produced of quality materials by skilled craftsmen and are Unconditionally Guaranteed and Economy Priced. Fine plush lined, genuine leather case and straps.

A USER WRITES
"I received my 8x40 Glasses. I am very pleased with them. Even with the haze in mountains the glasses are very clear. I showed them to several of my friends and you will probably be receiving orders from them. . ." K. H. R., Philadelphia, Pa.

Measure 5½" x 6¾". Very Fine Field of View. Angular Field, 6.9 degrees. Lightweight. Exit Pupil — 5 mm. Water, Dust Resistant. Carry UNITED "Seal of Quality".

8x40 INDIVIDUAL FOCUS... \$54.50
8x40 CENTER FOCUS..... \$59.50
(WITH INDIVIDUAL FOCUSING RIGHT EYE)



WHERE PRICE AND QUALITY ARE "UNITED"

7x35 WIDE ANGLE 578 FOOT FIELD

MAGNESIUM - ONLY 2 1/2 OZS.!
Needle sharp definition and brilliance. Fine resolving power. Color Corrected Achromatic lens. **Wide Angle Binoculars** allow you to follow moving objects with ease, for you see **MORE** from left to right. Plenty of light gathering power with these **CENTER FOCUS** Glasses. **NOTE PLEASE** these glasses give you a **WIDE ANGLE** field of not 375 or 400 or 450 or even 525 but **578 FEET** at **1000 YARDS!** United's new streamlined wide angle binocular measures 4 1/2 x 7 1/2 inches — **\$69.50**

SIMILAR MODEL!
Very Good Quality, But not up to Standards of Above **\$49.95**
Model. 525 Ft. Field —

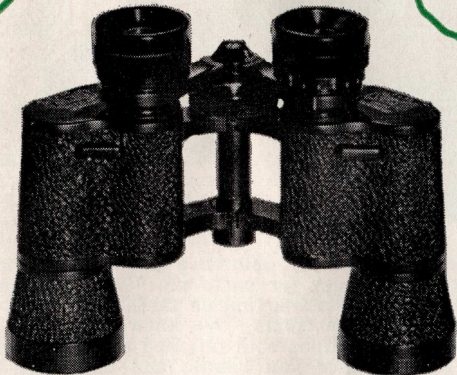
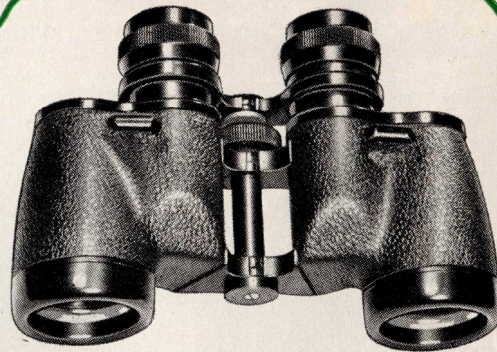

"ALL PURPOSE" 7x35 ARISTOCRAT

This fine quality **Center Focus** Binocular is one of UNITED'S Latest, created to give you **QUALITY** at an **ECONOMY** price. Newest Streamlined designing plus improved manufacturing techniques combine to make the "Aristocrat" the wanted glass.

Brilliant illumination with razor sharp detail of definition. Weighs but 20 ounces and is only 5 1/2 inches high. These fine glasses come complete with handsome plush lined cases and straps. See and Try . . . **YOU WILL BELIEVE!**

\$34.95

QUALITY MERCHANDISE AT ECONOMY PRICES

Ever seeking new, better binocular performance UNITED consistently year after year introduces to the American public Binocular wants at Prices average Americans can afford to pay. **UNITED** value! Internal surfaces of vital prisms and front and rear Achromatics are **Coated** with Magnesium Fluoride to assure you brighter, sharper, clearer image. Made in Japan, these precision constructed UNITED binoculars are produced of quality materials by skilled craftsmen and Unconditionally Guaranteed and Economy Priced. UNITED was first to offer vest pocket size, "Whisper Weight," 16x50 binoculars, 20X 12 ounce and 15x65, etc., at popular prices. Now these superb "STREAMLINED" creations . . .



Your GUARANTEE
of FINE OPTICAL QUALITY
at Money Saving PRICES



Weigh Only 27 Ounces Each!
Easy to Hold, Easy to Focus!
10x50 Center Focus \$59.50
12x50 Center Focus \$67.50
16x50 Center Focus \$74.50

Three More UNITED FIRSTS!

Heretofore when a sportsman wanted a high powered binocular he had to contend with bulkiness and weight. For in the past high powered binoculars were made of heaviest metals for durability and because of their large size weighed as much as 5 pounds each. This made high powered glasses exceedingly difficult to hold steady for any great length of time.

However, **NOW** with today's light, yet completely sturdy metals available and with modern construction design UNITED is pleased to offer to sportsmen needing and wanting long range viewing high powered **ZEPHYR WEIGHT** binoculars which are truly **EASY TO HOLD** and **EASY TO FOCUS**. 10x50 is 6 1/4 inches high and has field 260 feet at 1000 yards. 12x50 is 7 inches high and has 240 foot field. 16x50 is 7 inches high with field of 210 feet.

FINE VALUE—ECONOMY PRICE

To assure you of securing bright, sharp, clear images in these high powered, zephyr weight binoculars the internal surfaces of prisms and front and rear achromatics are coated with magnesium fluoride. In addition, they are of course Achromatic, with color corrected lenses and are made water, dust resistant. Made in Japan, these precision constructed UNITED Binoculars are produced of quality materials by skilled craftsmen and are unconditionally Guaranteed and Economy Priced. These three center focusing binoculars with individually focusing right eye pieces come with handsome plush lined, leather cases and straps.



from FAR AWAY ALASKA

come these welcome words "Your 16x50 high powered glasses are invaluable in checking the condition of a bear's fur a mile away. . . ." J.M.

KEENE, N. H. Writes . . .

"I received the 12x50 binoculars in perfect condition. They are really wonderful. I am perfectly well pleased with them." . . . I.E.B.

Texas says . . .

"I received the 12x50. Clear and razor sharpness at close and long distance." A.N.

. . . and **NEW YORK** expresses "The 10x50 I bought two years ago are a fine pair of binoculars."



MB

THE Falcon 20 POWER PRISM BINOCULAR

WEIGHS ONLY

18 OUNCES!!

\$39⁹⁵



Is your guarantee of satisfaction. Insist upon it!



POWER, COMPACTNESS, ECONOMY PRICE

Never in the 100 years since Carl Zeiss invented the prismatic binocular has it been possible to secure a superbly made 20 POWER PRISMATIC binocular, weighing only 18 OUNCES and at the amazing price of only \$39.95!

Only UNITED'S tremendous buying power makes this possible.

Precision made in every detail. Handsome durable crackle finish with satin chrome trim. Individual focus with removable, screw-in, protective dust caps! Lens are color corrected AND interior surfaces of VITAL front and rear Achromatics have been COATED for sharper, crisper, images at all distances. EXCLUSIVELY MADE IN JAPAN TO RIGID UNITED REQUIREMENTS which explains why the Price is so low and the quality so high. Comes with fine leather case and straps.

TRY FOR 30 DAYS AT OUR RISK AND EXPENSE

Test, use and compare. If you are not 100% satisfied return for full refund. UNITED has made you this no risk free trial offer since 1936 — you must be completely satisfied or your money back!

ORDER TODAY. . . . LOWER TAXES

Price complete with handsome plush lined leather case and straps, \$39.95 plus new lower 10% Federal Excise tax. For SAME DAY AIRMAIL shipment add \$2.00.



POWER PRISM

BINOCULAR WEIGHS 6½ OUNCES

Introducing "Magic Eyes" in a Vest Pocket size binocular. Smaller than even a woman's palm, these superb, ALL Chrome, 7 POWER PRISM, Achromatic glasses are a revolutionary binocular discovery. A 7 POWER Prism Binocular, not a field glass! AND they offer the user an excellent field of view of 340 Feet at 1000 yards. Optical craftsmanship at its very finest. Made in Japan. These precision constructed UNITED Binoculars are produced of quality materials by skilled craftsmen and are Unconditionally Guaranteed and Economy Priced. The All Chrome construction is precision machined in every way. UNITED'S "7 Power Magic Eyes" are adjustable to every eye width and every eye variance. These fine UNITED binoculars have been coated with applications of magnesium fluoride to the interior sides of the VITAL front and rear achromatics assuring you brighter, sharper, clearer images. The Ideal Binocular for those who want a powerful compact glass.



PUBLIC EDUCATION ART DIRECTOR WRITES:
 "I am enclosing herewith my check for a (Pocket) Binocular similar to the one you sent me. The FIRST party I showed it to asked me to get one for HIM. . . It is the best glass of it's kind I have seen to date." A.P.G., Wis.

SATISFIED USER IN MONTANA WRITES:
 "Received first pair 7 power Binoculars. Want second pair for neighbor." Mr. R.G.

LEATHER CASE & STRAPS are included at above price! Cases are quality leather and plush lined. Both case and neck straps included at \$19.95 price. Add usual federal tax.



Approved By Leading Outdoor Magazines
 American Rifleman reports: "Have thoroughly tested — where light, small, compact binoculars are needed." etc.
 Hunting & Fishing magazine Publisher tried our 7x Vest Pocket, liked it so much he bought one for his own personal use!
 Another Leading Outdoor Magazine wrote: "Vest Pocket 7 Power is surprisingly good — amazing in fact."

A LIFETIME OF PLEASURE

Introducing FOR THE FIRST TIME..

10 POWER POCKET BINOCULAR..

Another UNITED First!

A sensational optical achievement — A 10 POWER, palm sized 'Whisper Weight' binocular. Master optical craftsmen have created a glass that was heretofore thought impossible.

Weighs Only 6 1/2 Ozs.

Imagine a full 10 Power Prism binocular with Achromatic color corrected lens; precision machined in every way with finely balanced prisms for brighter, sharper, clearer images. Lustrous satin chrome with black trim. Sturdily constructed for a lifetime of use. These fine UNITED binoculars have been coated with applications of magnesium fluoride to the interior sides of the VITAL front and rear achromatics, assuring you brighter, sharper, clearer images. We offer here a pocket sized 10 Power binocular with just about perfect balance for long range or regular viewing. Made in Japan, these precision constructed UNITED binoculars are produced of quality materials by skilled craftsmen and are Unconditionally Guaranteed and Economy Priced. Brings images right up to you, clear, crisp and sharp. Seeing is believing. Measures only 3x3 1/2 inches and has an excellent field of view.

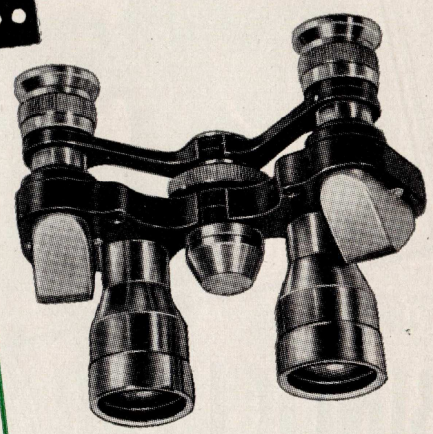

With Genuine Leather Carrying Case and Straps
INDIVIDUAL FOCUS

\$24.95

Add Usual Federal Tax

Same Model in Center Focus
(Illustrated Above)

\$29.95 Plus Tax

Including fine leather case, straps.



HERE IS WHAT THEY SAY ABOUT UNITED POCKET BINOCULARS

"The 6 Power and 7 Power pocket size binoculars were so good I gave them as Christmas Presents. Please send me..." H. C. M., Connecticut.

"I have used the one I bought many months. It is amazing what such a small glass can do. It would be worth its weight in gold on a long hike in the wilds where a larger glass would be left at home." H. M. D., Oregon.

"7x Vest Pocket size binocular thoroughly satisfactory in every way." Miss S. O., Canada.

"Your small glasses are TOPS. Rush another pair." Dr. W. P., Arizona.

"OK in every respect." Judge I. A. H., Florida.

"My friends are amazed at their power." D. M., Washington.



WHEN YOU THINK OF BINOCULARS.. Think of



BINOCULAR CENTER OF AMERICA

Don't second guess when spending Binocular Dollars. Get ALL you can for your money—BUY UNITED Binoculars.

UNITED GUARANTEES each and every binocular they sell. Have used an absolute 30 DAY MONEY BACK OFFER since 1936! UNITED'S "Best-By-Test" binoculars come from 3 continents and UNITED'S central location assures you quicker delivery no matter where you live.

UNITED Binocular offerings are final choices after putting hundreds of different kinds, sizes of binoculars thru rigid field tests. Every possible factor is weighed. The quality of construction, the field of view, the way a glass balances in the hand, the weight of the binocular, the precision grinding of the lenses, whether they are worthy of UNITED'S NAME and the UNITED "Seal of Quality" and THEN the important decision... can the binoculars be mass produced to retail at popular prices. Even after meeting every such test, new binocular models are then sent to binocular experts for their candid opinions.

Even then UNITED testing is not completed—for if a binocular should not meet the exacting needs of early buyers, their various suggestions are carefully considered and if practical, new designs are created to fill such existing needs.

It is why we say again—When You Think of Binoculars—Think of UNITED

FIRST WITH THE BEST

QUALITY SELECTION FROM THREE CONTINENTS



CENTER FOCUS
7x7 3/8 inches
Field at 1000 yards
is 369 feet!

WHAT YOU SEE WITH THE 7x50 CENTER FOCUS BINOCULAR



Note carefully that the above naked eye photograph barely discerns the hidden deer. Since Mother Nature protects her animals by having them wear coats the same color as their natural habitat, it is quite possible you might miss seeing the deer entirely. BUT, when viewed with the UNITED 7x50 instant finger tip adjusting binocular, the deer can easily be seen clearly outlined against the background.

The 7x50 CENTER FOCUS binocular UNITED presents has one of the highest light transmitting power of any binocular. Precision grinding of the lens and UNITED value combine to make this superb glass the first choice of thousands of sportsmen the country over. Economy buy! Internal surfaces of vital prisms and front and rear Achromatics are Coated with Magnesium Fluoride to assure you brighter, sharper, clearer images. In addition to CENTER FOCUS has an individually focusing right eye piece and interpupillary adjustment. Moisture-dust resistant. Made in Japan. These precision constructed UNITED Binoculars are produced of quality materials by skilled craftsmen and are Unconditionally Guaranteed and Economy Priced.

A UNITED FIRST guaranteed to give lasting satisfaction and has been SALE priced for immediate volume sales. **\$39.50**

Plush lined leather case and straps included at this price. Add usual Federal Tax.
These 7x50's are from a different factory than those shown on page 11.

7x50 INDIVIDUAL FOCUS 32 OUNCE \$36.00

Same as above, except is Individual Focus. Remember United has served over 600,000 since 1936 — 20 years of Binocular "Know-How!" Sale Priced. An economy value.

GUARANTEE.
UNITED offers you to
BUY IT — TRY IT. If
not completely satisfied
return within 30 days
for full refund!

QUALITY ARE UNITED

You Be the Judge

UNITED'S business is based on pleasing the customer. Nothing is spared assure giving you the customer absolute satisfaction. UNITED realizes that a good per cent of sales are to satisfied repeat customers and from people they in turn refer to us. UNITED'S tremendous volume is based on giving **More Quality at Lower Prices.**



20th Year of Binocular "Know-How"

When choosing a binocular you want the "BEST-BY-TEST" Binocular for your purpose. UNITED has served over 1,000,000 sportsmen the country over. We know what sportsmen require. Each year thousands of outdoor enthusiasts tell us both in person and in writing their good results with UNITED binoculars. UNITED anticipates needs and fills the wants of the most discriminating user. If you have any special problem please feel free to write to us.



old to Leading Institutions

Colleges from coast to coast use UNITED Binoculars. All colleges require **QUALITY AT THE RIGHT PRICE.** That is why we at UNITED so value their repeat sales. A governmental department tested a pair of UNITED Binoculars, found them such a value they bought forty additional pair for an expeditionary trip! This should not be construed as a governmental endorsement of UNITED Binoculars for that is forbidden but it does show **QUALITY AT THE RIGHT PRICE.**

Over 100 Models From All Over the World

You find over 100 models listed in these catalog pages. Hundreds of other makes, powers, etc., were tested and rejected. UNITED'S test include binoculars from United States, Japan, Germany, Switzerland, etc. Those shown are the "BEST-BY-TEST" **PRICED RIGHT** binoculars we found. By selling only the best buys UNITED has become "America's Leading Binocular Retailer."



Leading Publications Approved

UNITED binoculars are regularly sent to outside sports authorities for their impartial, unbiased comments. Such outside opinions from unprejudiced experts provide added protection for UNITED customers. Ask any leading outdoor magazine about UNITED—they know.

United Seal of Quality

Make sure the binocular you buy bears this seal. It is your assurance of top optical performance. It tells you that the binocular has satisfactorily met every UNITED test for size, power, weight, performance, and price. Don't be satisfied with less or pay more. **BUY UNITED—AND BE SURE!**



UNITED BINOCULAR CO.
WHERE PRICE AND QUALITY ARE "UNITED"

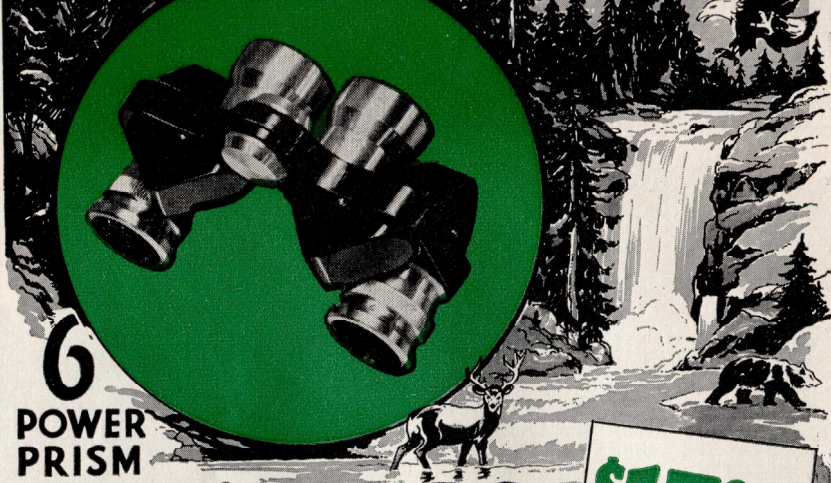

**6
POWER
PRISM
BINOCULARS**

\$17⁹⁵

- INSTANT FINGER TIP ADJUSTMENT
- POCKET SIZE COMPACTNESS
- COMBINES POWER, RANGE, WEIGHT
- QUALITY CONSTRUCTION, PERFORMANCE
- CARRY UNITED "SEAL OF QUALITY"



Precision ground optics for brighter, clearer images. Quality binoculars—now bargain priced. They bear the famous UNITED "Seal of Quality" because they are sturdily made of all metal construction with scientifically ground lens. These fine UNITED Binoculars have been coated with applications of magnesium fluoride to the interior sides of the VITAL front and rear achromatics assuring you brighter, sharper, clearer images. Only 3 inches long! Made in Japan. These precision constructed UNITED Binoculars are produced of quality materials by skilled craftsmen and are Unconditionally Guaranteed and Economy Priced. Weighs 5 ounces! A full 6 power prism binocular! Color Corrected Achromatic lens! Crystal clear field of view 370 feet at 1,000 yards! Complete with fine Leather Case, and Straps.

READ WHAT EXPERTS SAY

"American Rifleman" Says
 "Recently we have been testing a 6 POWER BINOCULAR sold for \$19.50 (old price) plus tax by UNITED, Chicago. Neat, attractive, stoutly made, gives good clear image and a good glass for the money. . etc.

"TRUE" Magazine Says
 "For cost, performance and compactness, we find these 6 Power Prism Binoculars good for every general purpose."

Lt. Col. Chas. Askins
 FIREARMS EDITOR of HARDWARE writes us, "I experimented rather extensively with your binoculars, used them a great deal in the dense woods during the late evening and early in the morning. They are really A-1"

"American Legion" Says
 "Now you can get close-up views of sports events, wild life, etc. Thanks to radically different design, etc. Offered by UNITED, Chicago.

MB

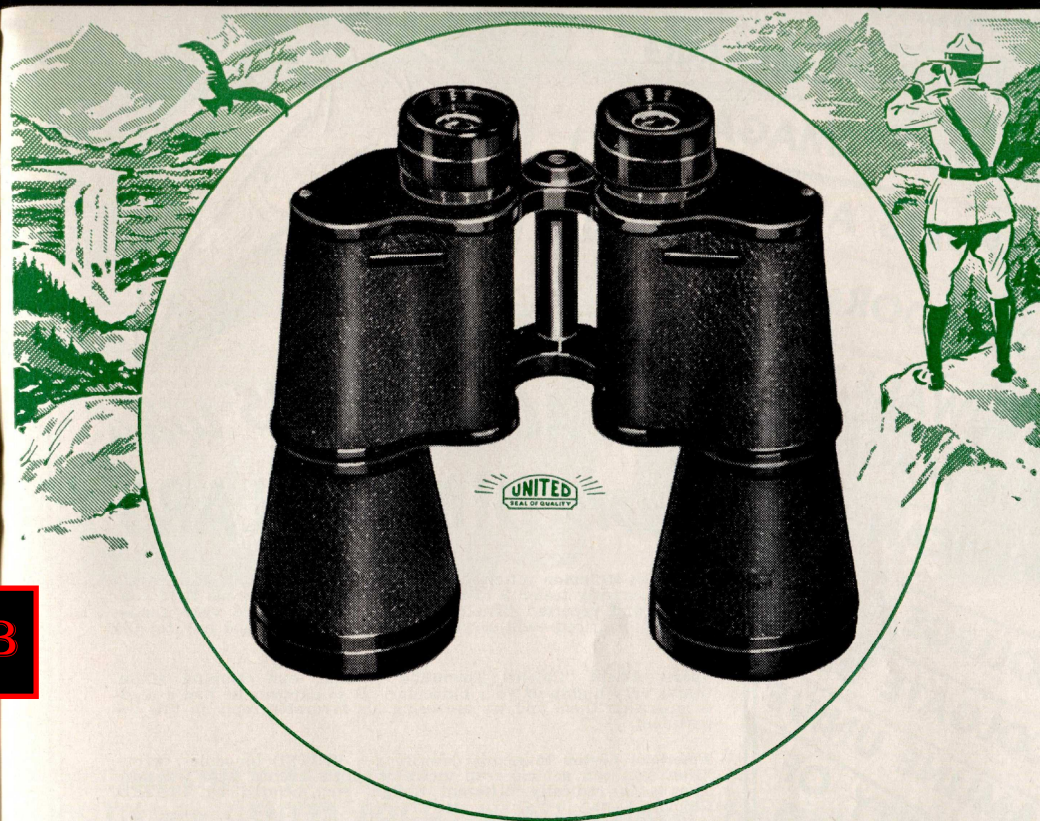

16x50 BINOCULAR \$69.50

Easy to Hold — Easy to Focus — Weighs only 27 ounces!

With these superbly made, tremendously powerful binoculars one has a feeling of standing on top of the world! Being able to travel hundreds of miles with his eyes while standing absolutely still! For views that are miles away, suddenly like magic, seem "next door." **UNITED VALUE!** Internal surfaces of vital prisms and front and rear Achromatics are Coated with Magnesium Fluoride to assure you brighter, sharper, clearer images. Water dust resistant. Full 16 power yet weigh only 27 ounces and stand only 7 inches high.

GREATER POWER—GREATER DISTANCE

Possessors of this fine glass often remark "This must be the ultimate in a fine binocular." Made in Japan. These precision constructed UNITED Binoculars are produced of quality materials by skilled craftsmen and are Unconditionally Guaranteed and Economy Priced. An excellent value at \$69.50 including fine leather case and straps. We quote from a recent letter—from a UNITED binocular dealer in Georgia:

"The 16x50 binoculars arrived OK and the customer is exceedingly well pleased. They are the most powerful binoculars I have ever seen and the party exclaimed when he looked through them . . . 'They are out of this world!'"

CENTER FOCUS Same Model in Center Focus with Individual Focusing Right Eye **\$74.50**



TRY ONE MONTH AT OUR RISK

UNITED - BINOCULAR CENTER OF AMERICA

AMERICAN RIFLEMAN
 HUNTING & FISHING
 OUTDOOR MAGAZINE
 SPORTS AFIELD
 OUTDOOR SPORTSMAN
 HARDWARE WORLD
 TRUE MAGAZINE
 AMERICAN LEGION
 COLLEGE OF SA
 COLGATE UNIV
 HAMLINE UNIV
 UNIVERSITY OF
 NEW MEXICO



From **AUTHORITIES** *who*
know **BINOCULARS**

American Rifleman official publication for the National Rifle Association recently tested 3 of our binoculars under average field conditions and reported "Featherweight—the optics are very good—moderately priced—will serve general purposes—a good buy for the money . . ."

Sports Afield "Colonel Townsend Whelen, our camping editor, thinks very highly of your binocular. It so happens he had a reader query on them and we are using his favorable reply in this department. . . ."

American Legion Magazine describing a UNITED binocular, wrote, "Now you can get close-up views of sports events, wild life, etc.. Thanks to radically different design, etc., offered by UNITED, Chicago.

Southern Governor of one of the leading states in America has repeatedly bought binoculars from UNITED.

Warren Page, Shooting Editor, Field & Stream, "From what experience I have had with them, there is no doubt but what both sets of glasses (7x35 and 8x40) are of excellent quality both optically, mechanically. . . ."

Hunting & Fishing, publisher, L. F. McClure, tried our UNITED "Vest Pocket" binoculars, immediately liked them, and bought a pair for his personal use.

Ted Kesting, Editor, Sports Afield, "Colonel Whelen, Camping Editor, thinks very highly of your binoculars. . . ."

National Advisory Committee for Aeronautics specified, "United Binocular Co.'s binoculars or fully equal."

Western Sportsman Magazine, "The UNITED people are making one dickens of a good price on a 16x50 featherweight glass that ought to be down a sportsman's alley. Looks like a good buy to me."

AIRMAIL SERVICE!
 WE ARE PREPARED TO SHIP
 ANY BINOCULAR
 SAME DAY BY "AIRMAIL"
 Add the Following Airmail
 Charges When Ordering
 All Pocket Models, Rifle Scopes
 and 30X Telescope . . . \$1.00
 6 or 8 Power, 15-40X . . . \$2.00
 Wollensak Telescope . . . \$3.00
 7, 10, 12, 16, or 20 Power . . . \$4.00
 15x65 . . . \$4.00

United German BINOCULARS



WEIGH ONLY 15 OZS! !
BOTH are CENTER FOCUS with Individual Focusing Right Eye

The entire world has long recognized and admitted the superb craftsmanship, fine optical qualities, matchless performance, dependability and ruggedness of German made binoculars, for Germany has long been known as the Optical Center of the World.

UNITED is proud to announce that precision machined, optically perfect GERMAN BINOCULARS are once again available in the United States at UNITED'S popular prices! Their "Whisper Weight" will amaze you (weigh only 15 ozs.) All internal optics are **COATED**. Are CENTER FOCUS for instant finger tip adjustment and have individually focusing right eye pieces. 6x30 is 4 inches and 8x30 4 1/4 inches in height. 6x30 has 390 foot and 8x30 450 foot field at 1000 yards.

NEEDS ANOTHER
 "Last fall I let my hunting partner use the German binocular you sold me. Now I need another one. Send . . ." M. M. L. Dallas, Texas.

NICEST & HANDIEST
 "Your 8x30 Wide Angle German Binoculars are about the nicest and handiest—I would recommend them to anyone wanting an all round handy set of glasses." J. P. S., Kalamazoo, Michigan.

6x30	\$55.00
8x30	\$59.50

Fine German Leather Case and Straps Included. Add Usual Federal Tax



BUY UNITED AND BE SURE!

QUALITY SELECTION FROM THREE CONTINENTS

7x35 - \$69.50

CENTER FOCUS—17¾ OUNCES!

Exclusive with UNITED by mail order is the 7x35 center focus with individually focusing right eye piece. The usual ultra precision GERMAN craftsmanship is apparent at a glance and confirmed by its consistently outstanding performance for all internal optics are coated.

**ONE OF THE LIGHTEST
7x35 ON MARKET TODAY!**

Yet it has a LARGER FIELD (390 feet at 1000 yards)! Lens are made from GERMANIA GLASS known the world over for its high resistance to heat and great light transmitting power. 6 inches high. Water dust-resistant.

A "Whisper Weight" MAGNESIUM binocular (17¾ oz.) that with fine German leather case and straps is a buy of buys at \$69.50. Supply limited—so act quickly.



ONLY 17¾ OUNCES

MB

7x50 Center Focus German - \$99.50

**With Individual Focusing
Right Eye**

This quality optical masterpiece is of course made in Germany by skilled craftsmen trained from childhood to precision binocular workmanship. The optics are made of famous Germania Glass, known the world over for its outstanding performance.

**Magnesium Body—Weights
Only 30 Ounces!**

Has an excellent field of view of 7.3 degrees or 384 feet at 1000 yards. Exit pupil is 7.1 mm and light transmitting power is 50.4. Stands 7 inches high and is water and dust resistant. All internal optics are COATED with magnesium fluoride to assure you brighter, sharper, crisper images.

Comes complete with handsome, richly designed and sturdily created leather case and straps. Retail \$99.50 plus usual Federal Excise Tax.



Center Focus Masterpieces!

Weigh only 24-27 ounces!

True superlatively made "Whisper Weights!" In the past high powered binoculars weighed 4 to 5 lbs. each! Now German strong lightweight metals perfectly matched lenses and streamlined construction expertly engineered make possible highpowered "Whisper Weight" Binoculars. All internal optics are coated for that extra sharp, precise viewing. Water, dust resistant. Are Center Focus with individual focusing right eye for easy following of rapidly moving objects.

WEIGHS ONLY 27 OUNCES!

20x56 (6½"x9¼") \$99.50

Weigh only 25 oz.!

6x50 (Brightest ever! Ratio of 69!) \$86.50

7x56 24 oz. 89.50

8x56 24 oz. 92.50

10x56 24 oz. 95.50

Important: Note extra large 50-56 mm front lens which allows more light to enter giving you brighter images! Prices include fine German leather cases and straps.

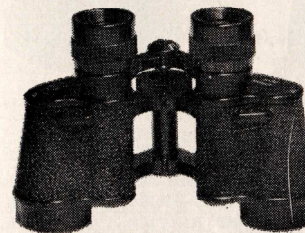
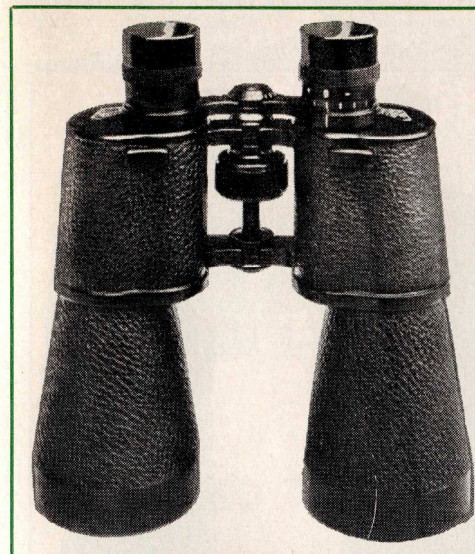

8x30 \$39.50

Weighs 10¾ oz.

One of the World's Lightest! This German "Whisper Weight" binocular gives you amazing optical clarity performance wherever you go. Its "Whisper Weight" and exceptional compactness (4"x5¼") makes using it a rare treat indeed. These fine German binoculars have been coated with applications of Magnesium Fluoride to the intersides of the vital front and rear achromatics assuring you brighter, sharper images. As with all extremely accurate German Center Focus binoculars it too gives you in addition an individually focusing right eye piece for absolute fine line definition.

As with all UNITED Binoculars, fine Leather Cases and Straps included.

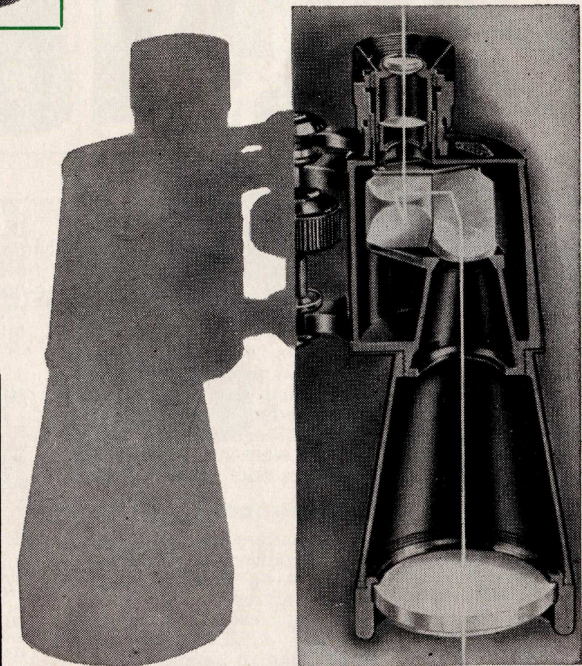

SCHÜTZ PRISMATIC SYSTEM
Provides increased intensity of light with compact construction, light weight. Course of rays shows special advantages of system.

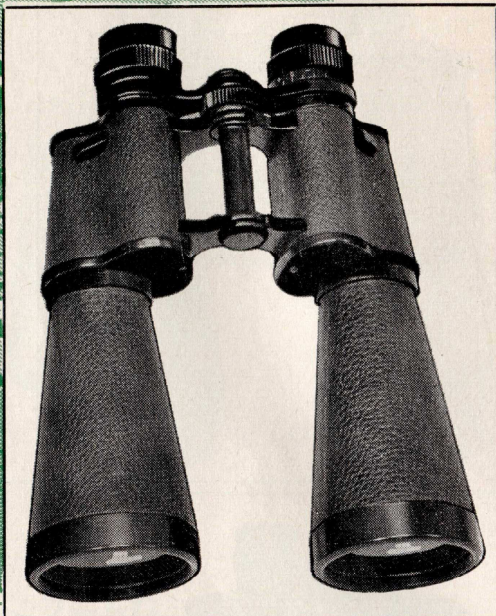
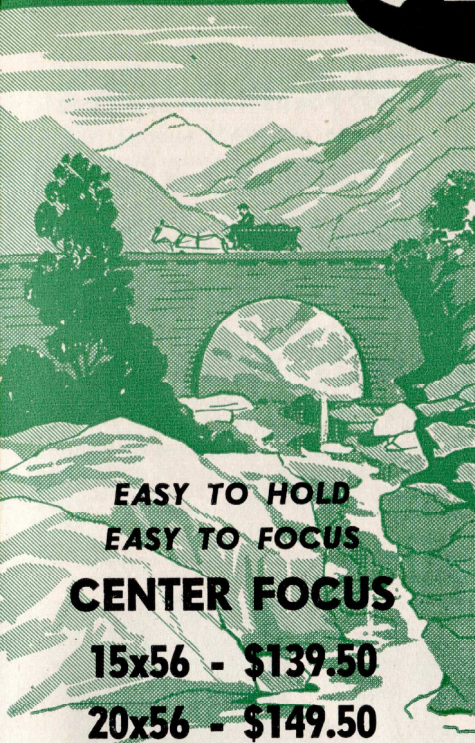

EASY TO HOLD
EASY TO FOCUS
CENTER FOCUS
15x56 - \$139.50
20x56 - \$149.50

Weighs Only 28 Ounces

Two of the finest binoculars we have ever handled. They offer Everything. Made to rigid UNITED requirements in Western Germany.

Power

Tremendous 15 Power or 20 Power binoculars . . . which ever you prefer. Made in Germany by men trained from childhood to precision optical grinding and binocular assembly. These two binoculars will give you POWER when you want it . . . and at your finger tip! Measures only 7x8¾ inches.

Performance

These two pair of binoculars will give you the absolute acme of power performance regardless of whether it be morning, noon or night. Precision constructed they give excellent light gathering power at all times, sharpness of image, etc. All internal optics are COATED. In addition to having center focusing they also have individually focusing right eye pieces!

Fine German Leather Case, straps included.



APPROVED BY LEADING SPORTS PUBLICATIONS

Consider The Price

It is hard to believe that so much Binocular Power and Binocular Performance can be offered for so low a price. There is no question in our mind that here are two of the greatest binoculars that we have ever offered.

PROOF

"I purchased from you a pair of 20x56 German Binoculars.

In the past 15 months I have traveled far and wide using them for Hunting, Sightseeing, Aircraft Spotting (I can clearly follow the highest Jet-Interceptor with them).

I have shown them to hundreds of Naval Officers, Tank Commanders, Military Intelligence Officers, State Police Officers, and they are thoroughly convinced of the quality and terrific clarity, tremendous power and field of view for such a jumbo glass of amazingly light weight. I am very proud to own such a precision optical instrument and it's handsome case.

Please send me your latest catalogue of binoculars and tell me about the 30 Power Scope that sells for \$9.95. I have given your company name and address to at least 50 people who used my 20x56's."

Always a UNITED Booster, Chas. E. R., Newtown, Penna.

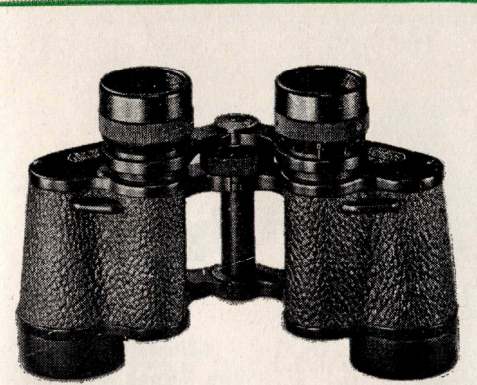

COATED OPTICS

(ALL Internal Optics are Coated)

- 6x30 Silvarmar \$100.00
(Individual Focusing)
- 6x30 Silvarem 110.00
(Central Focusing)
- 7x50 Binostar 175.00
(Individual Focusing)
- 7x50 Binocem 185.00
(Central Focusing)
- 8x30 Deltrintem 135.00
(Central Focusing)
- 10x50 Dekarem 205.00
(Central Focusing)
- 15x50 Pentekarem 250.00
(Central Focusing)

NOTE: Central Focusing also has Individual Focusing right eye.

Fine German Leather Case, Straps included. Add Usual Federal Tax

Model	Diameter of Exit Pupil	Light Transmitting Power	Field of View		Weight Ounces
			In Degrees	Feet at 1000 Yds.	
6x30	5 mm.	25	8.5	450	12½
7x50	7.1 mm.	50.4	7.3	384	29¾
8x30	3.75 mm.	14.06	8.5	450	14
10x50	5 mm.	25	7.3	384	31½
15x50	3.33 mm.	11.1	4.6	243	31½



A famous name in the optical world. For prismatic binoculars of the modern type were invented in Germany by Carl Zeiss in 1833 . . . 62 years ago. The ingenious use of prisms in Zeiss Binoculars were a revolutionary advancement, for not only was the field of view increased but a striking stereoscopic effect was created due to the objective lenses being set a greater distance apart than the eye pieces.

The Zeiss Binocular of today is a modern prism binocular brought to the peak of perfection by its own inventors. Because of their superb optical quality, their matchless performance, dependability and ruggedness, Carl Zeiss Binoculars have been used by the U. S. Navy, and by the armies and navies of most other nations. They are first choice of noted explorers, sea captains, big game hunters and famous flyers, many of whom have expressed their high appreciation of Zeiss quality.



UNITED GUARANTEES YOUR SATISFACTION

40x, 64x, and 89x With 4x Cross Hair Finder

A professional instrument for students of astronomy or for observing objects at tremendous distances. Precision constructed of the **FINEST** of materials by skilled optical craftsmen in Japan to rigid **UNITED REQUIREMENTS** which explains the **superb quality** available at an **economy price**.



View of the Moon . . .



Complete
With Tripod and
Fitted Wooden Carrying Case

\$129.50
NO FEDERAL TAX

United Quality Includes —

- Has giant front Achromatic Lens (60 mm.-almost 3 inches across).
- **THREE** Eye Pieces 20 mm, 12.5 mm and 9 mm.
- 4x Cross Hair Finder.
- Diagonal Prism for right-angle viewing.
- Objective Lens: 60 mm Diameter, fully corrected, Achromatic and of course **COATED**.
- Erecting Prism for terrestrial viewing.
- Weight of Telescope only 5¼ lbs.
- Weight of Tripod only 5¾ lbs.
- Weight of wooden, fitted, carrying case 6¼ lbs.
- Height with tripod extended - 5½ feet.
- Handsome, rich Ivory finish with contrasting black crackle. Or . . . All Black Crackle finish with chrome trim. State Which.

20 AND 25 POWER TELESCOPE

GIANT 50MM. FRONT LENSE

"Whisper Weight"
. . . Only 15 Ounces



A top quality Variable Telescope which can be changed from 20 to 25 Power in just a few seconds. Has **GIANT 50mm lens** which are about **TWO INCHES ACROSS** assuring you **maximum** light transmitting power meaning the image you view will be crisper and sharper because of the **GREATER** light transmitting power.

Select the power you wish to use - - or - - change to the other power in a matter of seconds. . . It's very simple, you remove or place in position a small optical lens assembly and the result will give you 20 or 25 Power, whichever you wish. Note the "Whisper Weight" please - only 15 ounces. This is possible due to modern durable and sturdy metals which assure long life with a minimum of weight. Precision constructed by skilled optical craftsmen in Japan to rigid **UNITED** requirements. Length - 14¼ Inches. Field of view at 20x is 66½ Feet at 1000 yards and at 25x is 56 Feet at 1000 yards. Inside of **VITAL** front AND rear Achromatics are **COATED** to give you clearer, sharper images. Use for close up, long distance or Astronomical viewing. There is **No Federal Tax** on Telescopes.

\$17.95



AMONG THE WORLDS FINEST



\$37.95

NO FEDERAL TAX!

Leather Case and
Straps Included

**60 MM
OBJECTIVE
LENS!**

**DEFIES
COMPETITION!
INVITES
COMPARISON!**

A delight to use and a
delight to own.

Here is why you should first try the United Achromatic UNOCULAR. You get twice the power (20 Power)! You get an objective lens that's 20% greater in size (60 MM)! Less weight (20 ounces)! Less bulk (only 8½" long)! The UNOCULAR (Half an expensive binocular) is a precision machined, scientifically ground **PRISMATIC** optical masterpiece. It **NOW** costs so little you really cannot afford to be without it.

40 POWER 60MM

PRISMATIC SPOTTING SCOPE

Don't confuse. **NOT** a telescope but like an **EX-PENSIVE** binocular it uses **Prisms** for less distortion, more width of field, greater clarity. Featherweight aluminum construction 20" long. 63 ft. field! Tripod is 22" closed, 57" extended. Ideal for astronomical use as well.

Quality manufactured in Japan to rigid **United** requirements of sturdy lightweight aluminum. The inner tubing is made of brass and chrome plated to give you slide-free, ease of handling. For **MORE** light to give you crisper images, the front lens are a giant 60mm which is a bit over 2½ inches across! Achromatic! This is a **Prismatic** telescope!

**Ideal For Close Up And Long Distance Spotting
As Well As Astronomical Viewing**

Use for close up as well as long distance viewing. Gives field of view from left to right of 63 feet at 1000 yards. Inside surface of **Vital** front Achromatic lens is **COATED** assuring you brighter, sharper images. Tripod is sturdily constructed of wood and metal and is 22 inches closed and can be opened to any height up to 57 inches. **NO FEDERAL TAX** - Handsome black crackle finish. **BOTH \$39.50** Scope and Tripod

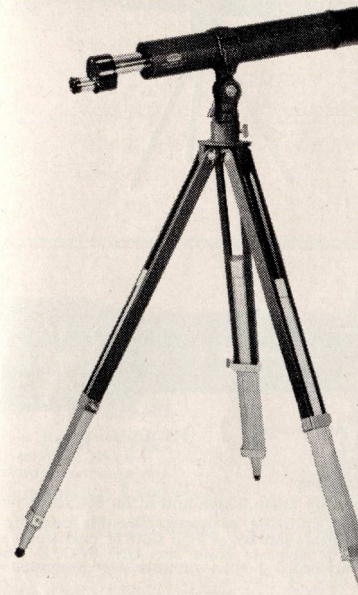

"The 40x60 Scope is well mounted, powerful and gives bright image. I can see a cigarette in a man's mouth more than 2 miles away. I have owned 9 telescopes in my life and this 40x60 beats anything I have looked through for the price. I find it to be the most complete telescope I have owned." Mr. Claude W., Draper, Va.



UNITED GUARANTEES YOUR SATISFACTION

30 POWER! 8½ OUNCES

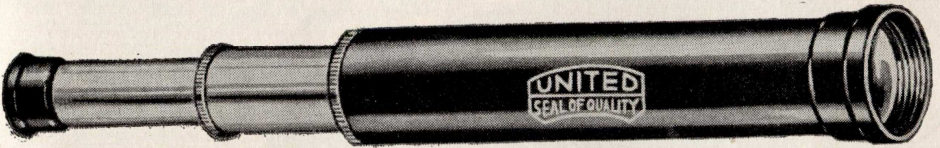

½ ounce Whisper Weight 30 Power Telescope for instant-on-the-spot focusing. Ideal for indoor, outdoor sports, vacationing, trips, long distance spotting. Pocket size — measures only 7" closed, 14½" open. This fine UNITED telescope has been COATED with applications of magnesium fluoride to the inside surfaces of the vital front achromatic lens to assure you brighter, sharper images. NOT A CHEAPLY MADE TOY TELESCOPE! But a precision machined (threaded fittings), precision ground achromatic telescope that invites comparison. Bears the famous UNITED "Seal of Quality." Made in Japan. All metal. Comes Complete with Handsome Carrying Case. Sturdy Adjustable Tripod \$3.99

\$9.95 NO TAX

Tripod \$3.99 Extra

50 POWER Prismatic Scope

BRINGS OBJECTS 50 TIMES CLOSER!

What you have always wanted. Tremendous power brings everything 50 times closer) and a giant sized objective lens (50 MM—over 2" across for brilliant viewing!) and at a sensationally low price! Weighs only 20 ounces! Only 18" long! 30.5 feet field at 1000 yds.! Not a mere Telescope. Instead just like an expensive Binocular it uses Prisms to eliminate distortion and to provide sharp crisp, detailed images at all distances. AND . . . the Vital inside front and rear achromatics have been COATED for brighter, clearer images. Luxurious, glistening ivory finish with beautiful chrome trim.

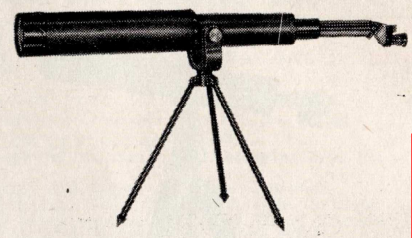

The Uni-Tripod is made of featherweight Duralumin, permits sighting up, down or across at any angle you want. Made in Japan by skilled optical craftsmen which explains why the quality is so high and the price so low. Complete outfit including the Prismatic 50x50 spotting Scope and the Uni-Tripod sent postpaid — TAX FREE for only **\$34.95**

MB

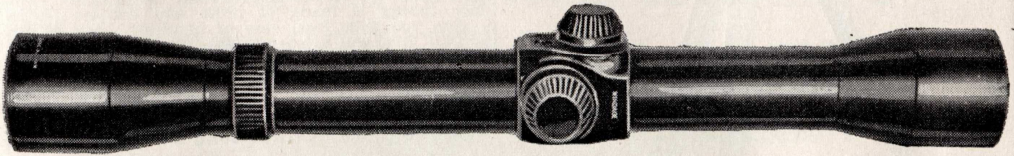

4 POWER 34.95

Featherweight - 8¾ ounces. Lightning Fast — Weather Resistant Accurate Sighting. Cross Hair Reticule Anti-Reflection COATED Needle Sharp Definition

The 4X UNI-SCOPE gives you everything you demand in a quality Rifle Scope and at an economy price. The 4X UNI-SCOPE provides lightning-fast sighting with hair splitting accuracy. Double adjustment (Internal windage and elevation adjustment with click stops!). Made in Japan by skilled optical craftsmen and carries the famous UNITED SEAL OF QUALITY etched right into the scope! Note the UNI-SCOPE has a 1 inch and NOT a ¾ inch tube which makes it adaptable for all standard 1 inch mounts recommended for your rifle. Can be used with Mounts Costing as little as \$9.75!

Bright, clear, crisp images. Will stand rough usage. Sleek, trim, streamlined beauty. Handsomely blued throughout. All this quality in the 4X UNI-SCOPE and at a price, only \$34.95.

UNI-SCOPE SPECIFICATIONS

Magnification - 4X
Diameter Objective lens - 30mm.
Eye Relief - 3-5½ inches (approximate).
Field at 100 yards - 33 ft.
Diameter of tubes - 1 inch, blued.
Length - 11¾ inches.
Weight - 8¾ ounces.
Sturdily Constructed of Feather-weight Aluminum Alloy.



SIX TELESCOPES IN ONE!

15 TO 40 POWER VARIABLE TELESCOPE

COATED OPTICS

- Use 15X—for nearby objects at wide angle.
- Use 20X—for target spotting scopes.
- Use 30X—for long distance terrestrial view.
- Use 40X—for celestial and astronomical observation.

To change the power, simply take the power tube between your fingers, turn to a click and your power has changed from 15 power to 20 power then to 30 power and to 40 power! As simple as that. Rust Proof chrome tubes. Weighs only 18 ounces. 9" when closed. 27" when extended.



Carries UNITED "Seal of Quality"

1. Images equally sharp and clear at all powers.
2. Power tubes graduated in click stops with intermediate markings permitting instant fixing of selected power—no guess work.
3. LENSE are COATED for greater brilliance of image.
4. Knurled ring on eyepiece draw-tube makes focusing easy and fast.
5. At 20 Power the telescope will clearly show .22 bullet holes at 300 feet.

\$33.50
FEDERAL TAX FREE!

Genuine Leather Case Included

USERS PRAISE IT

"Well pleased with it." D. S., Canal Zone.
"Just received your 15X-40X Telescope. It is tops. I like the scope fine." I. E. J., Arizona.
"I bought a Wollensak Telescope through your company. It is really and truly a fine scope. It has more than served my needs in Korea." Cpl. T. E. J.



Are Not Fully Satisfied Return for Prompt Refund in Full!



**7 POWER WIDE ANGLE POCKET
525 FOOT FIELD!**

In the creation of UNITED'S New 7 Power WIDE ANGLE Pocket Binocular, our Optical Craftsmen achieved what seemed to be the impossible. Experts said it could not be done, that bulk and weight were an optical necessity in order to create a WIDE ANGLE Pocket binocular.

Our Optical Engineers spent many months testing, checking, creating and rejecting ideas and models until the day finally arrived when a model was created to meet rigid UNITED requirements.

This fine quality 7 Power Pocket WIDE ANGLE Binocular measures only 3 x 4½ inches and weighs but 15½ ounces. It has 25 mm. front lens and gives a WIDE ANGLE Field of 525 feet at 1000 yards; Lustrous satin chrome with glossy black trim. Comes in handsome push lined case, complete with straps for only.

\$39.95 (Plus usual Federal Tax)

7X Wide Angle Monocular (½ of the Above Binocular) with case — \$19.95 — No Tax!



Another UNITED FIRST

MB

ANOTHER UNITED FIRST...

15x65 CENTER FOCUS \$59.50

The wanted binocular. Tremendous power, brilliant illumination, has light transmitting power of approximately 19—almost as much brightness as a 7x35! Wide field of view. Streamlined designing plus lighter, stronger metals make this 15 power glass easier to hold and use than many glasses half its power! Water-dust resistant. 8½"x9"—51 oz.

GIANT FRONT LENS ALMOST 3 INCHES ACROSS

Objective lens are giant size—65mm, or almost 3 inches across! Interior sides of VITAL prisms and front and rear Achromatics have been COATED for crisper, sharper images — made by skilled optical craftsmen in Japan. 30 DAY NO RISK TRIAL. Return for refund if dissatisfied. Center focus with individual focusing right eye piece. Add Lower 10% Federal tax. Genuine leather case, straps included.

"I have given my 15x65 binoculars test after test for long range use, such as spotting Jet Planes etc. These are quickest focussing glasses I have ever owned and pin-point, ultra sharp, at ranges to the moon. At 200 ft. from top of mountain I could see Ephrata, 32 miles away and air was hazy. My old 20x50 could not do this. Thanks for selling me such a perfect glass." Mr. William T., Ephrata, Penna.



Magnesium! Same model in 39 oz. "Whisper Weight" Magnesium \$69.50

TRY ONE MONTH AT OUR RISK

A LIFETIME OF PLEASURE

40

POWER

UNI-SCOPE

\$27.95

COMPLETE WITH TRIPOD

NO FEDERAL TAX

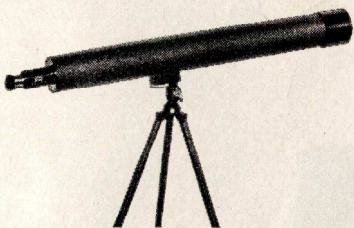

26" long! Weighs 34 oz. 60 mm (2½" across) front objective lens! Ordinary spotting scopes are only 30 mm to 50 mm. Has 7 lens including Achromatic objective and a Kellner rear ocular lens! Interior side of VITAL front objective has been COATED another reason images appear in such minute detail. Made of aluminum tubing for light weight with Chrome plated, brass inner tubing for snug, yet slide free ease of handling, UNI-TRIPOD made of featherweight Duralumin and has two screw set-up take-down construction. Permits sighting up, down or across at any angle you want. Made in Japan. Ideal for Rifle Range checking, Sports, Astronomical Observation, etc.

8x25 ECONOMY BINOCULAR — \$19.95

12 OUNCES

UNITED is proud to introduce this new ECONOMY Binocular that will give you good performance, is sturdily constructed, and will stand average rough usage, but is priced "well below" normal retail prices. A brilliant light-weight UNI-COATED binocular that embodies all of the features of more expensive models. Compact, precision made. Provides a sharp, clear brilliant field of 390 ft. at 1,000 yards. ¾" high! Sensational low price makes it a buy of buys.

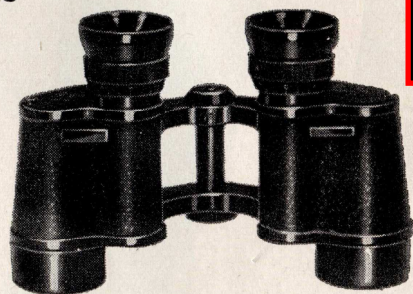

MB

\$19.95

SAME MODEL BUT IN CENTER FOCUS — \$24.95

7x35 Monocular \$29.95

Measure only 2½x4¾".

Weighs 8½ ounces! A monocular is HALF of a PRISMATIC binocular. An ideal glass for hunters, sportsmen, vacationers, etc., because of its compactness, size and weight. Made in Japan. Easy to carry and simple to use with one hand.

Fine Leather caps and straps.

7x50 — \$32.95

There is NO Federal Tax on Monoculars.

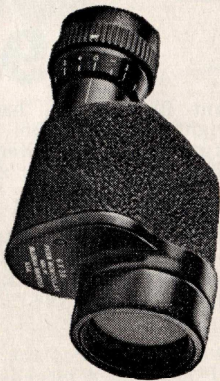

100, 200, 300 Power Turret MICROSCOPE—\$14.95

Amazingly precision construction. Mass Production and low overhead makes this low price possible, for now beginners, students and adults can thrillingly explore the microbe world, study plant life, the mysteries of inorganic matter, etc. See the structure of human hair, the wonders in a simple drop of water. Examine finishes of metals.

Has 100, 200, and 300 power objectives, each on a rotating nose-piece, so you can easily change the power. Made of metal. Swivel at base for inclined viewing. Piano substage mirror illuminates the slide. Has real rack and pinion gears for easy focusing. Comes complete with hardwood case. Made in Japan. There is NO Federal Tax on Microscopes.

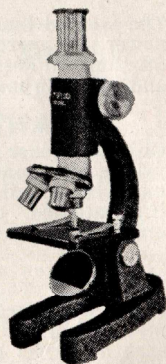

WHERE PRICE AND QUALITY ARE "UNITED"

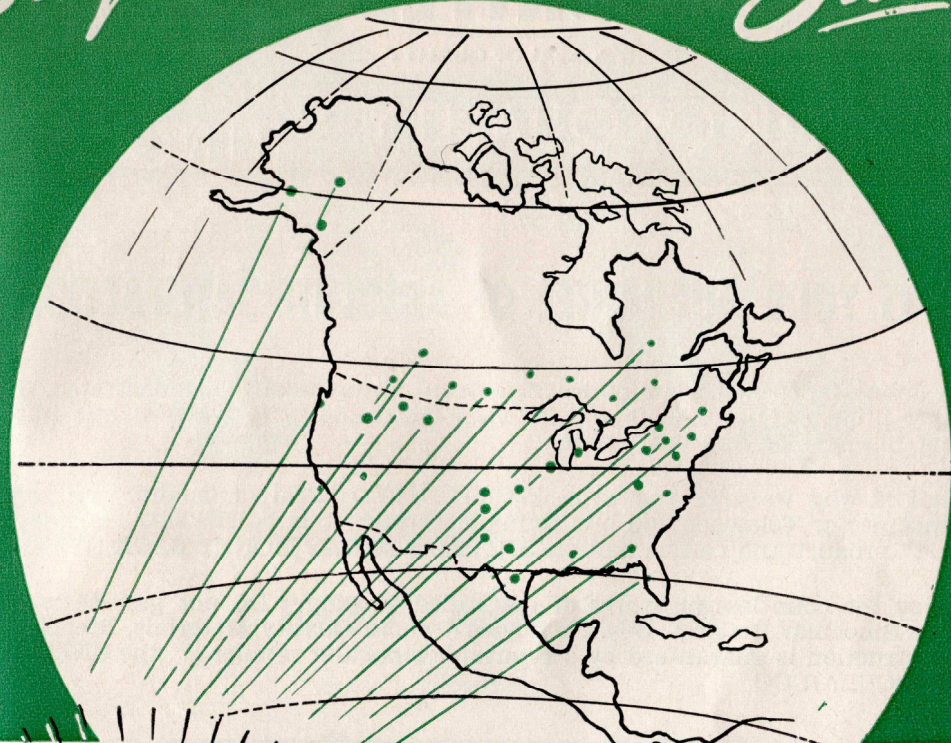

UNITED

SEAL OF QUALITY

... Is your guarantee of real value. This seal etched into your binocular certifies the binocular has satisfactorily met every UNITED test for size, power, weight and performance. Do not be satisfied with less or pay more. This seal is your GUARANTEE OF SATISFACTION.

THOUSANDS OF SATISFIED CUSTOMERS

Over 600,000 men and women from all parts of the United States and many parts of the world testify to UNITED'S policy of SQUARE DEALING. Don't guess — BUY UNITED and BE SURE.

PROOF!

"I must say that UNITED are one of the squarest shooters I have ever dealt with. It would be a pleasure if you care to use my name for a write-up. I purchased a pair of 6 power binoculars and binocular specs and found them OK. I am one of the oldest picture machine operators in the business today. . . ." Walter A. Bemis, New Jersey.

"I was given your address by a friend of mine who is very well pleased with your binoculars. Please send me . . ." R. A. C., New York.

"Have seen the 7x50 binoculars purchased by Mr. L. L., a year ago and I like them very much. Enclosed find check . . ." C. E. S., Kansas.

"About two years ago I bought a 6x30 binocular, well pleased and have recommended you to friends. Please send . . ." R. W. L., Illinois.

Johns Hopkins Medical School bought UNITED Binoculars for research work in conjunction with the U.S. Navy in Alaska and after testing they bought two additional pair!

Look for this **UNITED** SEAL OF QUALITY on Your **MARK OF QUALITY** BINOCULAR

IT IS YOUR GUARANTEE OF ABSOLUTE SATISFACTION

As John Hancock, the immortal American, dramatically demonstrated, it takes pride in one's beliefs and in one's merchandise to warrant one putting his Seal of Approval on it.

That is why we urge you to seek the UNITED "Seal of Quality" on any Binocular or Telescope you buy to make certain it is a UNITED "Best-By-Test" product and can be had on UNITED'S 30 DAY MONEY BACK OFFER.

Enjoy the countless pleasures of magnified viewing. Do not gamble with your Binocular Dollars. Buy a Binocular whose Quality Materials, Precision Construction is guaranteed by a reputable binocular retailer . . . the UNITED BINOCULAR CO.

SINCE 1936

UNITED BINOCULAR COMPANY has filled the needs of over 600,000 customers in all parts of the United States and in many parts of the world.

Each and every piece of UNITED merchandise has been sold on an unconditional Money Back Guarantee. The *BUY* and *TRY* policy has been one that UNITED has followed from its very beginning. *Its simplicity is your protection.* You buy a binocular or telescope. You try it for your own special purposes and then if it does not meet your re-

quirements or if you feel that we have not accurately described it in every minute detail, simply return it for an immediate unquestioned refund of every cent you paid us. Your complete satisfaction is our main concern.

It might interest you to know that our total cash refunds amount to less than two per cent of our gross sales and of these *many admit that the fault lay on the part of the buyer, his wants and what he could at the moment afford to pay and not with the merchandise.*



WHERE PRICE AND QUALITY ARE "UNITED"

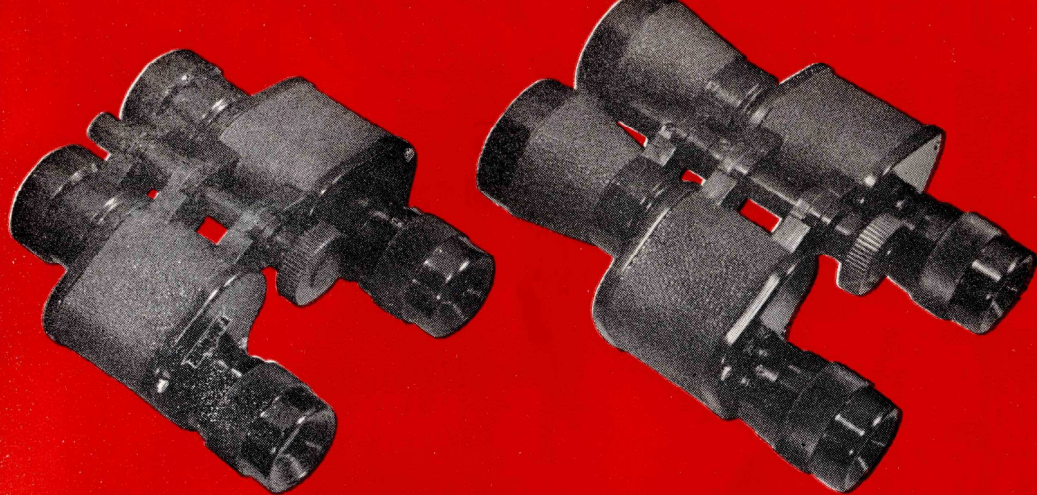

8x30 AND 10x30

United

German Pocket Binoculars

The Aristocrat Among Pocket Binoculars!

Smaller and more compact than usual Porro Prism Binoculars. The wide angle of view, splendid definition of image, freedom from color and lense aberrations, the excellent light transmitting power, all combine to assure you truly top quality performance under most conditions.

Add to the above the fact you are obtaining all of these features plus wide field of view (430 feet at 1000 yards in the 8x30) in a quality German made binocular weighing but 14 OUNCES!

Excellent quality German optics, skilled "Old World" craftsmen, Achromatic lense, are more reasons why this latest UNITED creation should be among your valued optical possessions. All internal optics are COATED. CENTER FOCUS PLUS INDIVIDUAL FOCUSING EYE PIECES!

8x30 — 430 Foot field at 1000 yards. — — \$59.50
Weighs 14 ounces

10x30 — 320 Foot field at 1000 yards. — — \$79.50
Weighs 16 ounces

(Complete with fine German leather cases and straps)



A LIFETIME OF PLEASURE

10x50	-	GERMAN — CENTER FOCUS	-	\$54.95
		Not shown in catalog. Weighs 26 ozs., Measures 6x7 inches.		
10x50	-	CENTER FOCUS	-	\$39.55
		(Regular price \$59.50). See page 15, the enclosed catalog.		
10x24	-	POCKET SIZE	-	\$9.90
		This is a discontinued pocket model which was replaced by our 10x20 style. Weighs 6½ ozs., Measure 3x4 inches. Very similar to the model on page 18 except has less chrome and front lens, is 24 instead of 20 mm. These are in need of repair. Many have parts missing. We are selling "as is" to be repaired locally, or taken apart by yourself for experimental work. Many people create a Monocular of parts available from this glass. These cost us NEW \$17.28 each! Your Price \$9.90.		
10x50	-	AMERICAN DU MAURIER	-	\$44.90
		American made. Du Maurier brand. 28 ozs.! Individual focus. A very fine glass, almost brand new. Have only 5 pair.		
12x50	-	CENTER FOCUS	-	\$42.45
		(Regular price \$67.50) See page 15, the enclosed catalog.		
12x50	-	INDIVIDUAL FOCUS	-	\$29.70
		Not shown in catalog. Individual focus. 35 ozs., while they last at this low price. Have only 14 pair. Are identical in appearance to the 16x50 on page 23 your catalog.		
16x50	-	INDIVIDUAL FOCUS	-	\$36.93
		(Regular price \$69.50) See page 23, the enclosed catalog. A bargain offer like this will not last long for our stock is not too plentiful of this model. ALL ARE SHELF-WORN, NONE ARE USED IN SENSE THAT SOMEONE ELSE OWNED THEM. While they last.		
16x50	-	CENTER FOCUS	-	\$42.90
		(Regular price \$74.50) See page 15 the enclosed catalog).		
15x65	-	CENTER FOCUS	-	\$49.90
		(Regular price \$59.50) See page 35, the enclosed catalog.		
20x56	-	GERMAN — CENTER FOCUS	-	\$84.75
		(Regular price \$99.50) See page 27 the enclosed catalog.		
20x56	-	GERMAN — CENTER FOCUS	-	\$119.65
		(Regular price \$149.50) See page 28 the enclosed catalog.		
15x — 40x	-	VARIABLE TELESCOPE	-	\$26.60
		(Regular price \$33.50) See page 33 of the enclosed catalog.		
20x	-	FALCON — INDIVIDUAL FOCUS	-	\$28.95
		(Regular price \$39.95) See page 16, the enclosed catalog.		
20 POWER	-	SPOTTING SCOPE	-	\$19.90
		(Regular price \$24.95) See page 40 the enclosed catalog.		



BRAND NEW 6 x 36 WIDE ANGLE "UNITED COMMODORE" — \$36.80

An exceptional Wide Angle (what you see from side to side) binocular yet only 5"x6¾" in size. Weighs only 32 ounces!

498 FT. FIELD AT 1000 YARDS

Has light transmission of "36" which makes it brighter than even an 8x40! Sharp, clear and bright for entire optic system has been fully COATED both inside and out. Complete plush lined leather case, straps. BRAND NEW!

Regular Price \$89.50 CLOSE OUT PRICE ONLY \$36.80

Add \$1 postage and handling. Brand New.

No Risk Money Back Guarantee

The same United Guarantee applies to the above binoculars as with all United glasses. Test, try and compare for one month, if you are not fully satisfied, return for refund in full!

Come Complete With Leather Cases, Straps

All of the above come complete with handsome leather cases and straps. Add usual 10% Federal Excise Tax to all binocular prices. Telescopes are tax free.

NONE SOLD OVER COUNTER!

All of the binoculars we have shown above are available BY MAIL ONLY. The reason is obvious—frankly, at these very low prices, we cannot afford the time of a sales person, for to retail at these prices, the time we give each order must be a minimum, for I'm sure we all agree, today, time is money!

CLOSE - OUTS

NEW — GERMAN MOLLER POCKET MODELS

Among the finest to come out of Germany, we featured these for many years in a page ad in our catalog. These sold for \$124.50 to \$154.50. They were discontinued, frankly speaking, because the average customer did not wish to invest that sum of money. In other words, we did not receive enough orders to make it wise to continue devoting a valuable page in our catalog to them. We have a few remaining and are closing out these BRAND NEW Binoculars at OUR ACTUAL WHOLESALE COST.

These Aristocrats Among Pocket Binoculars Fit in the Palm of Your Hand!

6x24—435 foot field at 1000 yards!—Weighs only 13 ounces—Was \$124.50
CLOSE OUT PRICE \$79.35

8x32—335 foot field at 1000 yards—Weighs only 14 ounces—Was \$144.50
CLOSE OUT PRICE \$88.90

Come complete with beautifully created plush lined German Leather cases & straps.

30 and 50 POWER VARIABLE TELESCOPE

Tremendous power and utility in an all desirable Variable Telescope. You have available 50 or 30 power right at your finger tips.

In a matter of seconds you can change from 30 to a gigantic 50 power by simply screwing another small optical lens assembly into position. We would like to repeat that statement—you can change from 30 to 50 power or back from 50 to 30 power in seconds time.



**WEIGHS ONLY
17½ OZS.!**

Sturdily constructed of light weight aluminum alloy for dependable service under all types and kinds of conditions. All parts precision constructed by skilled optical craftsmen to assure you service, fine results and long life. Made in Japan to rigid United requirements. Field of view at 30x is 44½ feet at 1000 yards and at 50x is 30½ feet at 1000 yards. Inside of vital front and rear Achromatic lens COATED for sharper, crisper images. Use for close up, long distance or astronomical viewing. Swivel tripod permits viewing from any position or angle, or it can be set in one permanent position.

23½" in Length
Telescope weighs 17½ ozs.
Tripod weighs 15½ ozs.

Telescope and Tripod
Complete

Regularly \$29.95

CLOSE OUT

\$19.95

NO FEDERAL TAX

WE REPAIR BINOCULARS

If your binocular is out of optical alignment, is in need of recollimation (you see double images, have eye strain, images are fuzzy, hazy, etc.) then send the binocular to us Insured and prepaid and our expert binocular Repair Department will realign the optical system after removing all optics to clean them thoroughly. All moving parts will be checked and the binocular will mechanically receive a general overhaul.

MAIL YOUR BINOCULAR TODAY

Send us your binocular insured and prepaid. We will give you an estimate and if this figure is acceptable to you, we will then proceed. If the price we quote is not acceptable we will return binocular.



Please Mail The Binocular To:

REPAIR DEPARTMENT

(Address on Next Page at Bottom)

40x - 80x Astronomical Assembling Kit

It's New! United's 40 and 80 Power Astronomical Assembling Kit. This Kit is Complete, nothing more to buy. Not necessary to obtain additional parts such as tube, etc., for in this Assembling Kit **Everything** is furnished right down to smallest part.

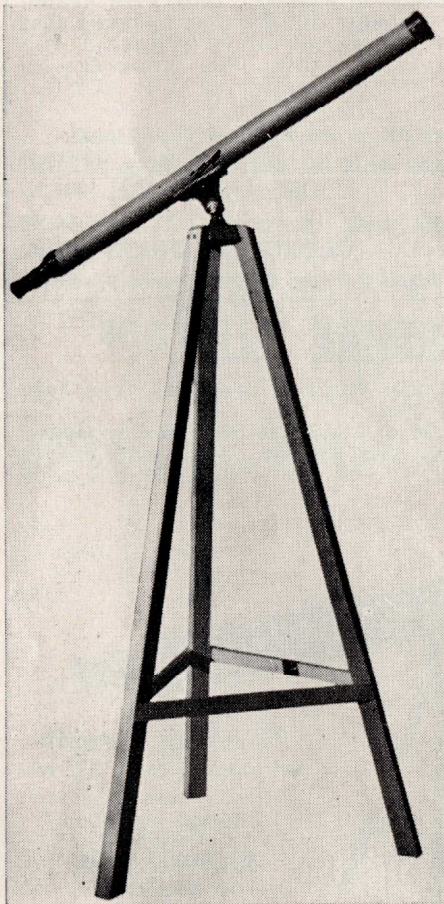

Regular Price \$34.95
Close Out \$29.85

It's Easy To Assemble. . . .

Anyone can assemble UNITED'S NEW Astronomical Kit. Comes complete with all necessary parts. All you need is a screw-driver.

Easy To Follow Illustrated Instructions

show you HOW to complete this quality Astronomical telescope quickly and easily. Each operation is illustrated with easy to understand pictures and drawings.

Things You Can See With This Telescope

With astounding clearness and in fine detail you will be able to see the Sun-Spot and Facula, the Moon's craters, mountains, and it's rough and uneven surface, the Ring of Saturn, the Cloud Belt and satellites of Jupiter, Nebulars, Clusters and the innumerable wonders of the heavenly bodies. You will find your UNITED Astronomical Telescope to be educational, interesting, recreational and fascinating to no end!

CONTENTS OF 40x-80x ASSEMBLING KIT

- 1 Objective lens with Cell. Type: Doublet Complete Achromatic. Clear aperture-40mm. Focal Length-1,000mm.
- 1 Eyepiece Holder with Drawtube.
- 1 Eyepiece. Huygens 12.5mm (80X) and 25 mm (40X). Combined type.
- 1 Sun Glass for observing the Sun.
- 1 Mounting. Tube support, swivel. Revolving part with collar.
- 1 Metal tube. Aluminum. Finished in rich black.
- 1 Wooden Tripod. Sturdy and durable.

Entire Telescope When Complete Stands 58 Inches High and the Tube is 39½ Inches Long. Made in Japan to rigid United requirements by thirty year old factory who hold over 34 important patents and have a world wide reputation for manufacturing Astronomical Telescopes selling in the \$1000.00 price range.

Shipped F.O.B. Chicago By Express



UNITED BINOCULAR COMPANY

9043 South Western Avenue

United Building

Chicago 20, Illinois

MB

USED BINOCULARS

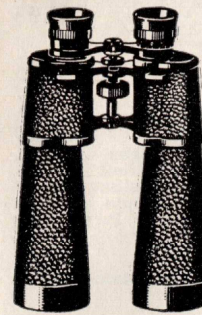

The following Used Binoculars are offered while quantities are available. Being used and shopworn, they cannot be sold as NEW UNITED Binoculars. You will find the frames have been scratched to a minor degree, some paint has been worn off and cases show scuff marks. PLEASE NOTE THEY ARE IN A-1 WORKING CONDITION, MECHANICALLY AND OPTICALLY and will give you the SAME EXCELLENT VIEWING RESULTS AS NEW BINOCULARS!

Use for a month, if you are not fully satisfied return for full refund.

6x15	-	-	POCKET MODEL	-	-	\$11.90
			(Regular Price \$17.95)		See page 22, the enclosed catalog.	
6x20	-	-	INDIVIDUAL FOCUS	-	-	\$19.95
			(Regular Price \$27.95)		See page 9, the enclosed catalog.	
6x30	-	-	GERMAN KLEITZ — CENTER FOCUS	-	-	\$24.65
			Not shown in catalog. Weigh but 11 ounces. Look very much like German Model on page 25, the enclosed catalog. Only 4 remain in stock. Cases used, binoculars "like new."			
6x30	-	-	INDIVIDUAL FOCUS	-	-	\$22.45
			American make by Talbot, U. S. Army glass from War I. Sturdy and strongly made. Used but fine working condition.			
7x15	-	-	POCKET MODEL	-	-	\$13.45
			(Regular price \$19.95)		See page 17 the enclosed catalog.	
7x35	-	-	CENTER FOCUS	-	-	\$34.80
			(Regular price \$49.50)		See page 10, the enclosed catalog.	
7x35	-	-	CENTER FOCUS	-	-	\$48.30
			(Regular price \$69.50)		See page 26, the enclosed catalog.	
7x35	-	-	WIDE ANGLE — CENTER FOCUS	-	-	\$49.30
			(Regular price \$69.50)		See page 14, the enclosed catalog.	
7x35	-	-	WIDE ANGLE — CENTER FOCUS	-	-	\$38.95
			(Regular price \$49.95)		See page 14, the enclosed catalog.	
7x40	-	-	CENTER FOCUS	-	-	\$34.90
			Not shown in catalog. Very similar to 7x35 on page 10 of catalog but with 40mm front lense. Very fine glass. Have but 7 pair remaining.			
7x50	-	-	INDIVIDUAL FOCUS	-	-	\$33.55
			(Regular price \$49.50)		See page 11, the enclosed catalog.	
7x50	-	-	CENTER FOCUS	-	-	\$36.85
			(Regular price \$54.50)		See page 11, the enclosed catalog.	
7x50	-	-	GERMAN — CENTER FOCUS	-	-	\$86.40
			(Regular price \$99.50)		See page 26, enclosed catalog.	
8x25	-	-	INDIVIDUAL FOCUS	-	-	\$17.90
			(Regular price \$19.95)		See page 36, the enclosed catalog.	
8x30	-	-	CENTER FOCUS	-	-	\$29.75
			(Regular price \$45.00)		See page 12, the enclosed catalog.	
8x40	-	-	INDIVIDUAL FOCUS	-	-	\$36.60
			(Regular price \$54.50)		See page 13, the enclosed catalog.	
8x40	-	-	CENTER FOCUS	-	-	\$39.30
			(Regular price \$59.50)		See page 13 the enclosed catalog.	
8x40	-	-	INDIVIDUAL FOCUS	-	-	\$31.90
			Not shown in catalog. Very good quality glass. Have but 5 left.			
10x30	-	-	INDIVIDUAL FOCUS	-	-	\$28.15
			(Regular price \$45.00)		See page 12, the enclosed catalog.	
10x35	-	-	GERMAN — CENTER FOCUS	-	-	\$49.50
			Not shown in catalog. German Dr. Wöhler. 23 ozs., Measures 5x6 inches. Have only 2 remaining.			

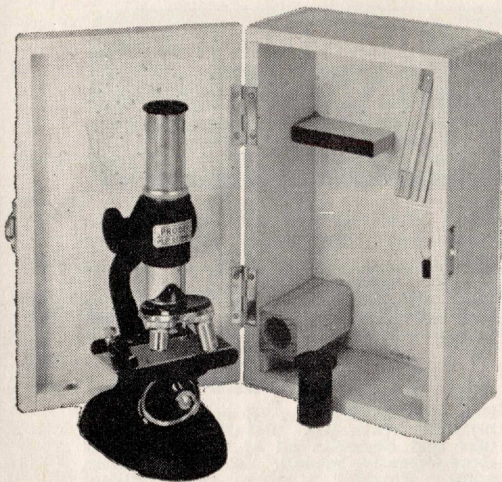

40x - 300x GERMAN MICROSCOPE

Despite its low price, this fine German made microscope embodies every feature needed for school study, hobby, advanced university study or pre-med work. Revolving turret contains three objective apertures providing maximum magnification.

Precision ground objective lenses.

Square stage with threaded slide clips and diaphragm. Double sided mirror. Precision ratchet type focusing mechanism. Huygenian type precision ground and polished eye pieces. Two interchangeable oculars (6x and 15x) provide magnifications shown in accompanying table. Jet black and nickel plated finish. All metal construction. Packed in a fitted hardwood dovetail cabinet with complete instructions. Supplied with one prepared and three blank slides, one of which has a well. **\$21.95**

Power of Each Turret
6.5x 13.5x 20x

Magnification obtained with 6x ocular	40x	80x	120x
Magnification obtained with 15x ocular	100x	210x	300x

MB

(For example when objective 6.5x is used with ocular 6x, magnification obtained is 40x. When objective 20x is used with ocular 15x, magnification is 300)

100x - 600x MICROSCOPE

Triple Revolving Turret
Two Oculars of 10X and 15X Give
You Magnification of—
100-150-200-300-400 and 600 POWER

Top quality construction through out. Explore the wonders of the unseen world in every drop of water, every leaf or grain of soil. Full Professional Type quality instrument. Achromatic optical system includes Oculars of 10x and 15x which will in turn give you total powers of 100, 150, 200, 300, 400 and 600. Handles with ease and smoothness.

Proven Quality for Students, Pre-Med, Technicians, etc.

Sturdy, solid base. Polished plano-concave sub-stage mirror. Precision ground and polished optics. Made in Japan by skilled craftsmen assuring brilliance of image. Adjustable arm, revolving turret, reliable slide holder. Comes complete in wooden case, with usual UNITED Guarantee to use and try for one month (30 days) **\$34.95** if you are not fully satisfied return for a prompt refund.

20x - 600x Microscope - \$159.50

Nine magnifications from 20 - 600x by combining the three ocular eyepieces of 5x, 10x, and 15x with the three revolving turret objectives of 4x, 10x and 40x. For simple, finger tip focusing the coarse and fine adjustments are located on BOTH sides of the Microscope. Almost identical in appearance to model pictured to the right. Comes complete in handsome wooden case.

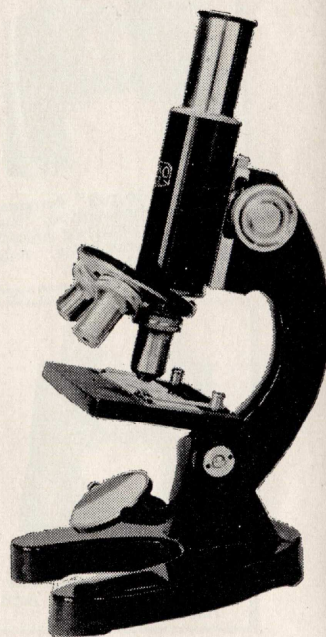

UNITED BINOCULAR COMPANY

9043 S. Western Avenue

United Building

Chicago 20, Illinois

LATEST BINOCULAR DISCOVERY

TWO BINOCULARS IN ONE!

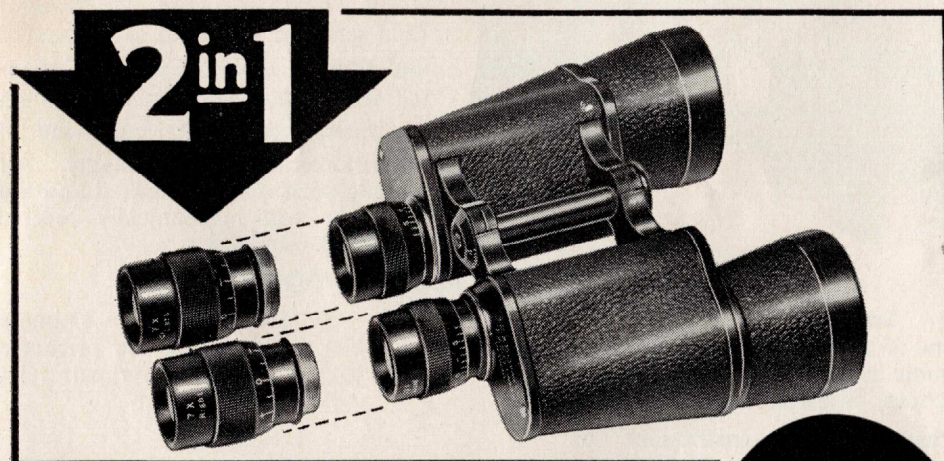

7x50 and a 12x50 IN ONE BINOCULAR

\$59⁵⁰

With a twist of your wrist you can change a superb, brilliant viewing 7x50 Binocular into a Super Powered 12x50 Glass!

You save half the ordinary costs for you actually get two binoculars for the price of one and still you need not bother to carry two binoculars for here in ONE binocular you have BOTH a 7x50 and a 12x50.

Use 7x50 for general all purpose viewing

Use 12x50 when Super Power is wanted

Here is how it's done—

This superb UNITED Binocular Discovery comes with TWO sets of eye pieces. One set is marked "7X" and the other "12X". When you wish to view with 7 power simply screw into position the two 7X Eyepieces and do the same when 12 Power is wanted. With a twist of your wrist you can have 7 or 12 Power! Included is a handsome carrying case for the Set of Eyepieces not being used. Simply slip in your pocket when not in use.

This perfectly balanced pair of UNITED Binoculars are precision made in every detail. Your field of view at 1000 yards is 372 feet at 7 power and 288 feet at 12 power. Weight only 33 ounces and Binocular stands 7 inches high. Water-Dust Resistant. Durable. Beautiful.

\$59⁵⁰

Comes complete with plush lined Leather Case and Straps

WE REPAIR BINOCULARS

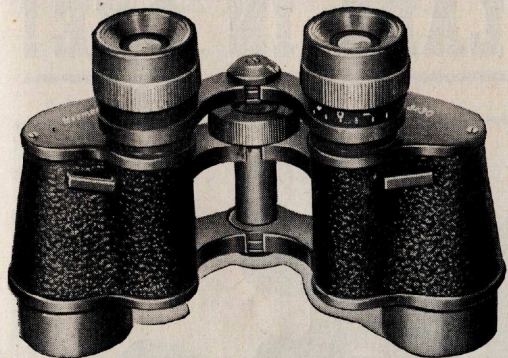

If your binocular is out of optical alignment, is in need of recollimation (you see double images, have eye strain, images are fuzzy, hazy, etc.) then send the binocular to us insured and prepaid and our expert binocular Repair Department will realign the optical system after removing all optics to clean them thoroughly. All moving parts will be checked and the binocular will mechanically receive a general overhaul.

MAIL YOUR BINOCULAR TODAY

Send us your binocular insured and prepaid. We will give you an estimate and if this figure is acceptable to you, we will then proceed. If the price we quote is not acceptable we will return binocular to you. (We also repair telescopes, riflescopes and microscopes!)

Please Mail The Instrument To:

REPAIR DEPARTMENT

(Address on Page One, at Bottom)



50 POWER-50 MM Prismatic SPOTTING SCOPE

\$34.95

**BRINGS
OBJECTS
50 TIMES
CLOSER!**

Includes
Scope and
tripod

What you have always wanted. Tremendous power (brings everything 50 times closer) and a giant sized objective lens (50 MM—over 2" across for brilliant viewing!) at a sensationally low price! Weighs only 20 ounces! Only 18" long! 30.5 ft. field at 1000 yds! Not a mere Telescope. Instead, just like an expensive Binocular it uses Prisms to eliminate distortion and to provide sharp, crisp, detailed images at all distances. AND . . . the Vital inside front and rear Achromatics have been COATED for brighter, clearer images. Luxurious, glistening ivory finish with beautiful chrome trim.

The Uni-Tripod is made of featherweight Duralumin, permits sighting up, down or across at any angle you want. Made in Japan by skilled optical craftsmen which explains why the quality is so high and the price so low. Complete outfit including the Prismatic 50x50 spotting Scope and the Uni-Tripod sent postpaid for only \$34.95! TAX FREE.

Economy WHISPER WEIGHT BINOCULARS

NEW DESIGN LOW PRICES EXCELLENT QUALITY

UNITED is proud to introduce this new line of binoculars that will give you good performance, are sturdily constructed and will stand average rough usage, BUT are priced "well below" normal retail prices.

So, if you are price shopping, we urge you to consider these ECONOMY PRICED "Whisper Weight" Binoculars. Please note they do carry UNITED'S trade mark.

UNITED stands in back of these binoculars with our usual UNCONDITIONAL 30 DAY FREE TRIAL GUARANTEE. Test for one month, if not satisfied, return for refund in full.

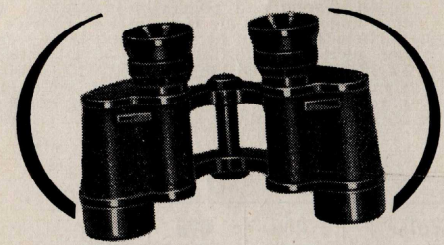

8 x 25—12 Ounces!

One of UNITED'S new "Economy" line. A brilliant lightweight UNI-COATED binocular that embodies all of the features of more expensive models. Compact, precision made. Provides a sharp, clear brilliant field of 390 ft. at 1,000 yards. 3 1/4" high! Sensational low price makes it a buy of buys. Add \$1.00 postage and handling. **\$19.95**

**7 x 35
\$27.95**
20 OZ!
Another UNI-COATED "Economy Line" binocular embracing top quality performance at a "wanted-to-pay" bargain price. Excellent illumination. 5 1/2" high! Razor sharp detail of definition. A sure to please binocular. Add \$1.00 postage and handling.

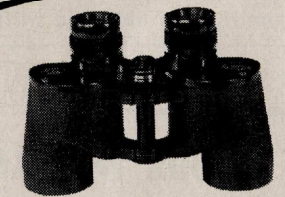

7 x 35 Wide Angle 525' Field \$49.95

Weights Only 26 Ozs.
Center focus. It's illumination and tremendous field coverage will absolutely amaze you. Angular Field 10 Degrees. One of the finest glasses ever offered. Compare value. Compare price. Add \$1.00 postage and handling. Uni-Coated.

**7x50
\$29.95**
26 OZ!
This UNI-COATED glass is the counterpart of one of the world's finest and brightest glasses. Objectives are 2 1/2" across providing tremendous illumination! Streamlined for ease of handling. 7 1/2" high. A superb binocular worth many times our low introductory price. Add \$1.00 postage and handling.

**12 x 50
\$39.95**
27 OZ!
Compare value . . . compare price . . . and you will rush your order. This giant power UNI-COATED "Whisper Weight" glass is only 7 1/4" high! Center focus with individually focusing right eye piece. Add \$1.00 postage and handling.



UNITED BINOCULAR COMPANY

9043 S. Western Ave. United Bldg. Chicago 20, Ill.

*"This is the Finest Binocular
I Have Ever Seen!"*

I WILL ALLOW YOU

**60 DAYS EXAMINATION
AND TRIAL USE**

IF NOT THRILLED, RETURN FOR REFUND!

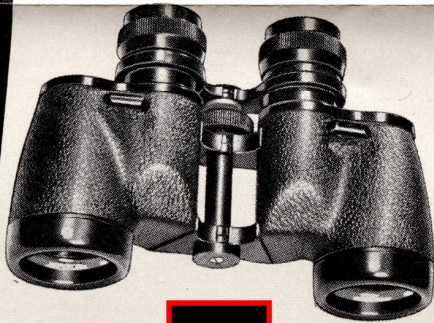

MB

7x35
550 FOOT
FIELD

*"I have never seen
anything like it
in 21 years . . ."*

Since 1936 I have personally tested hundreds of different makes, sizes, and styles of binoculars in search of quality worthy of carrying the UNITED "SEAL OF QUALITY." During this time I have sold millions of dollars worth of excellent binoculars.

A few short weeks ago, Northwest Airlines delivered a sample 7x35 Wide Angle Binocular from our agent in Japan. I immediately put it to every rigid test.

I found it performed better and had a wider field (550 ft.!) than wide angle glasses I checked that sold for \$99.50, \$125.00 AND UP! In addition, it provided sharper, clearer, brighter images *at all distances*.

It fit my hand perfectly, wasn't bulky, for it weighed only 28 ounces! Such a pleasure to use that I decided to allow all buyers a 60 Day Test Trial period! Regular price will be \$69.50. Introductory price, including fine genuine leather case and straps only **\$49.95**

Add Usual
Federal Tax.



UNITED BINOCULAR COMPANY

9043 S. Western Ave.

United Bldg.

Chicago 20, Ill.

MB

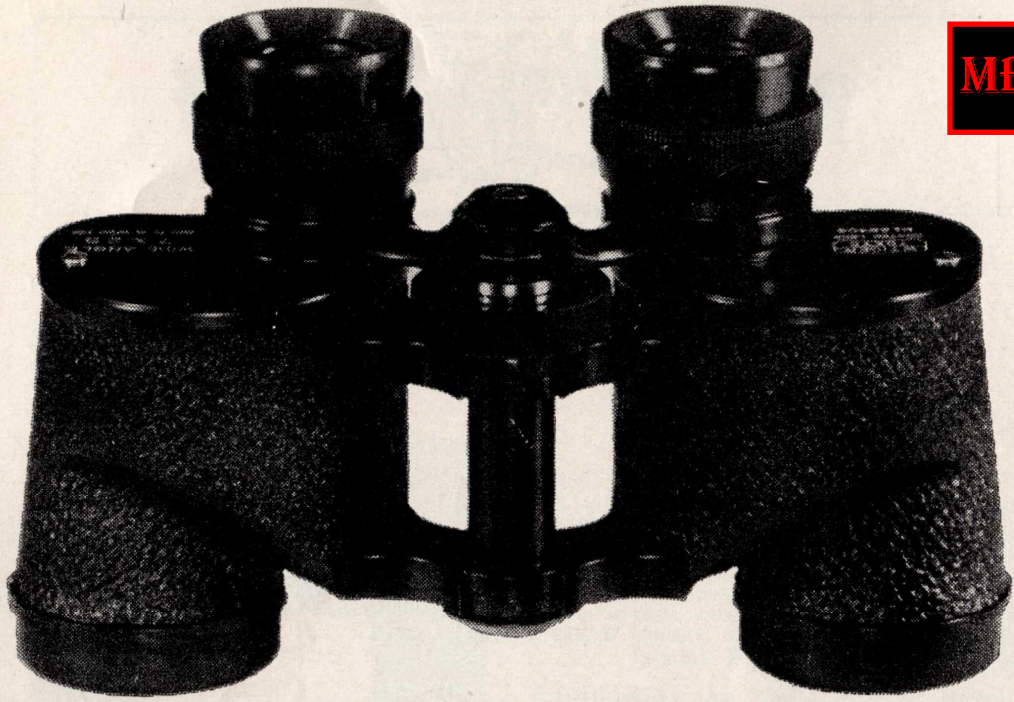

7x35 CENTER FOCUS — 17 Oz!

MAGNESIUM

Whisper-Weight **Magnesium** is an expensive metal, durable, stronger, still it is **Lighter In Weight** for this fine binocular weighs but **17 ounces**.

Another United **FIRST**.

A True UNITED "Seal of Quality" Optical masterpiece.

Has a field of 375 feet at 1000 yards, stands 6½ inches high. Is Center focus with individual focusing right eye piece. Comes in durable, handsome saddle stitched leather case complete with straps.

\$39.95

Add usual 10% Federal Excise tax.



UNITED BINOCULAR COMPANY

9043 S. Western Ave.

United Building
(Turn Circular Over, Please)

Chicago 20, Ill.

1909

UNITED BINOCULAR COMPANY



United Building - 9043 So. Western Ave.

Auburn Park Station

CHICAGO 20, ILLINOIS

POSTAGE WILL BE PAID BY

BUSINESS REPLY ENVELOPE

No Postage Stamp Necessary if Mailed in the United States

VIA AIR MAIL

FIRST CLASS
Permit No. 38191
Chicago, Ill.



BUY of the MONTH



8x25 CENTER FOCUS

\$24⁹⁵

A new addition to UNITED'S Fine line of over 103 Different Models . . . 8x25 in the All - Desirable CENTER Focus with individual focusing right eye piece, and at only \$24.95. Feather-weight — Only 12½ ozs., Compact — 3¼ inches high. Provides sharp, clear field of 390 ft., at 1000 yards. Achromatic! Color Corrected Lense!

Same Model But in Individual Focus \$19.95



MB

SALE! \$9.95

3 x 30 SPORT GLASS Regularly \$11.95

Another UNITED First! Proof of Superb Quality is the following, rarely found in low-priced Sport Glasses . . . All internal Optics Coated. Expensive addition of easy-focusing Center Wheel, 446 ft. field (8.5°) at 1000 yards. Frame is hinged to accommodate ALL eye widths. Is ALL Metal. Plastic covered barrels richly trimmed in chrome. Weighs 6 ozs., and stands only 2½ inches high. Exit pupil is 13 mm. Slips in your pocket, yet is ready for instant use in a second's time.

All models equipped with fine saddle stitched cases and straps. Add usual 10% Federal Excise tax.

(Turn Circular Over, Please)

Rush Order Blank

UNITED BINOCULAR COMPANY

Date

United Bldg.,—9043 S. Western Ave.
Chicago 20, Illinois

Gentlemen:

- Enclosed find \$ please ship the following order postpaid.
 Enclosed find \$2.00 as deposit, please ship the following order C. O. D. for balance due.

Quantity	Page No.	Description	Price
		Add correct postage here	\$
		Illinois Residents add 3% sales tax	\$
		Add ONLY 10% Federal Excise Tax on Binoculars	\$
		TOTAL	\$

SORRY, POSTAL RULES FORBID C.O.D. SHIPMENTS to: APO or FPO, Canada, Latin America, Cuba, Philippines and Foreign Countries. REMIT and we'll ship PREPAID.

Name Address
(PLEASE PRINT PLAINLY)

Rural Route Box

City Zone State

(Please Do Not Write In This Space)